

# The Camera

---

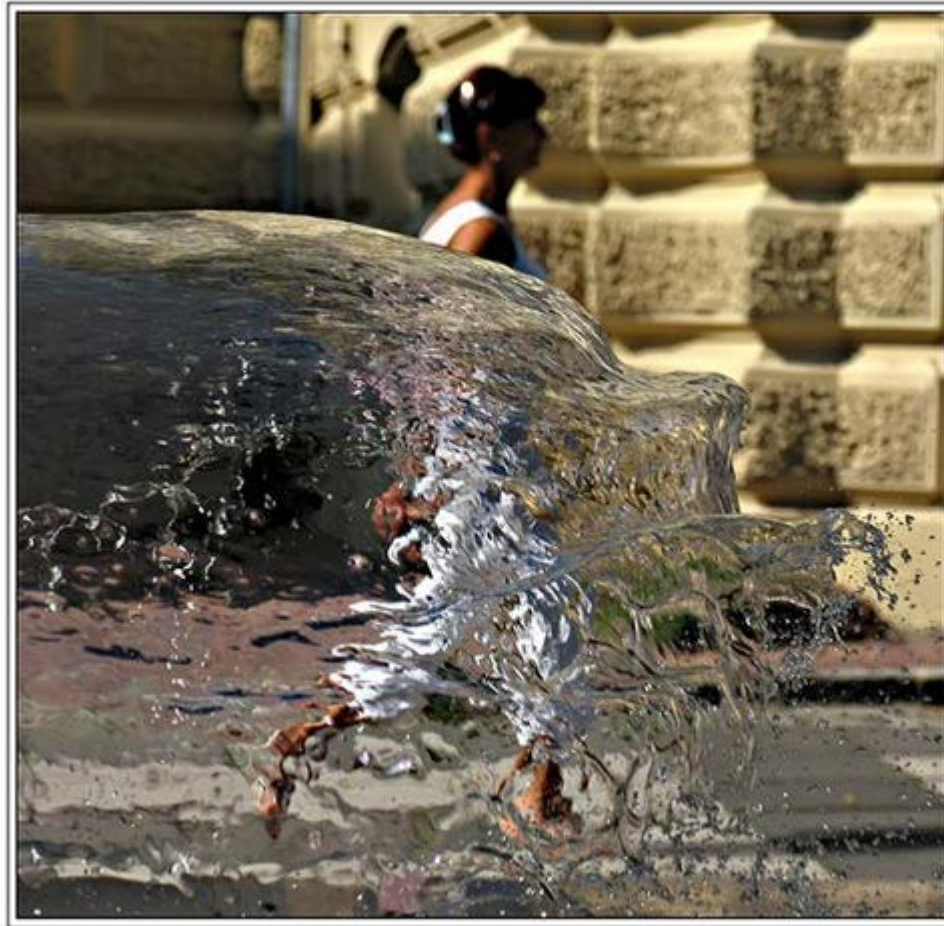

*(c) Tomasz Pluciennik*

# Image Formation

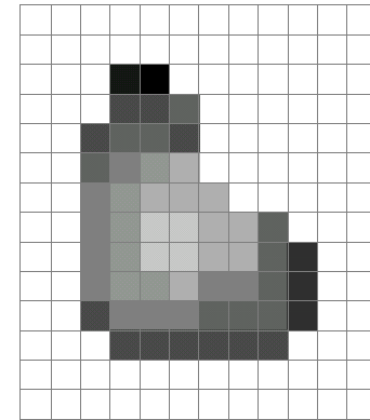
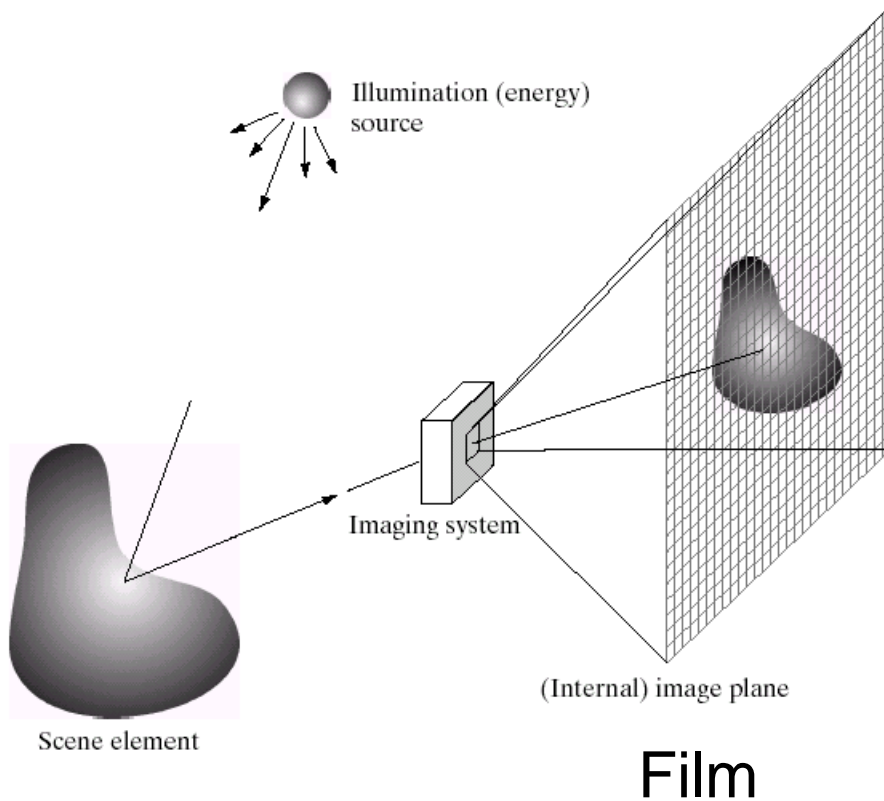

Digital Camera

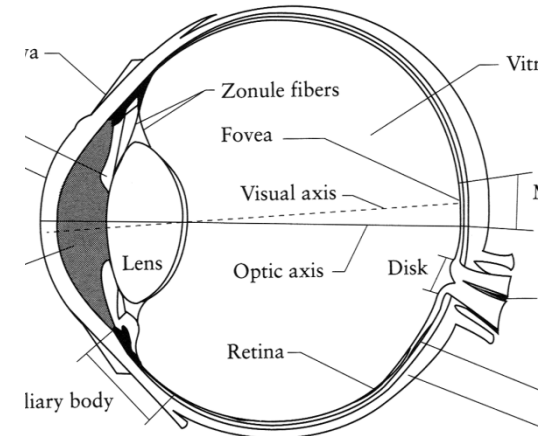

The Eye

# How do we see the world?

---

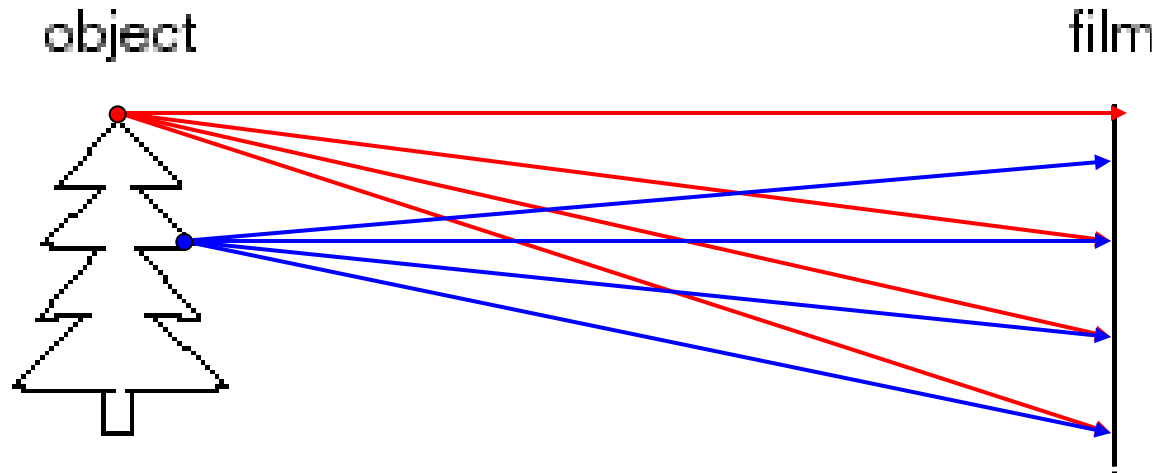

## Let's design a camera

- Idea 1: put a piece of film in front of an object
- Do we get a reasonable image?

# Pinhole camera

---

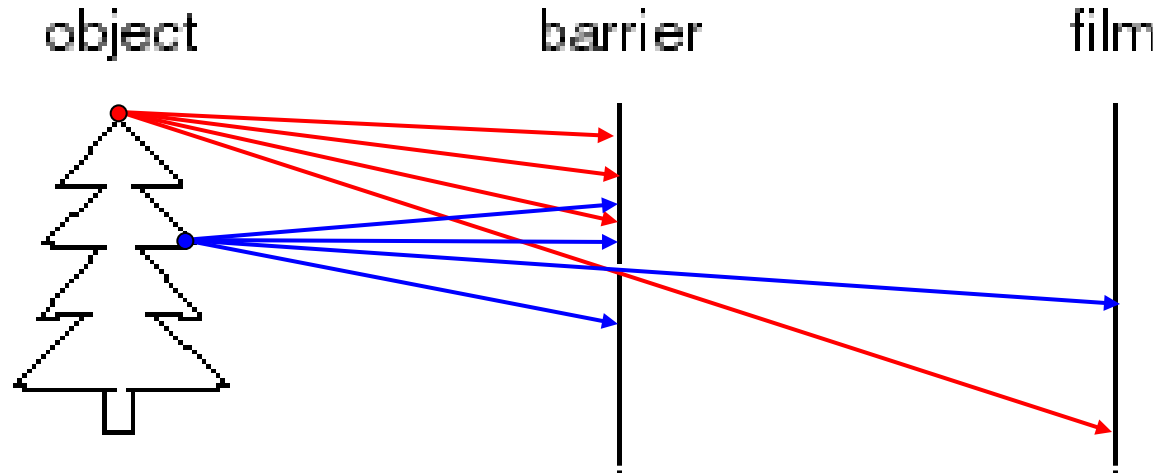

Add a barrier to block off most of the rays

- This reduces blurring
- The opening known as the **aperture**
- How does this transform the image?

# Pinhole camera model

---

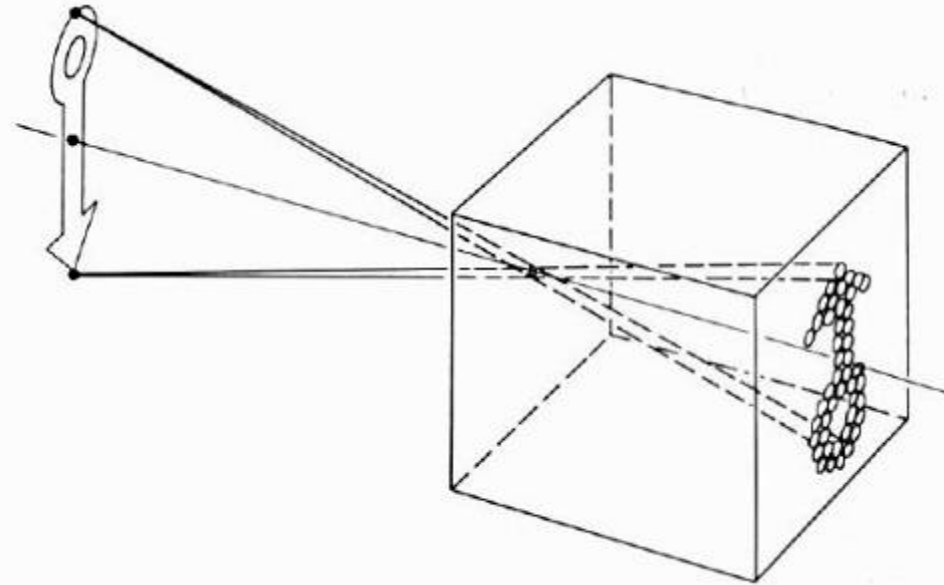

## Pinhole model:

- Captures **pencil of rays** – all rays through a single point
- The point is called **Center of Projection (COP)**
- The image is formed on the **Image Plane**
- **Effective focal length  $f$**  is distance from COP to Image Plane

# Dimensionality Reduction Machine (3D to 2D)

---

*3D world*

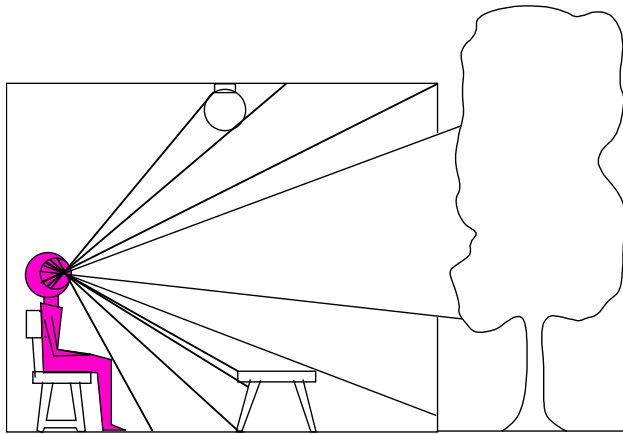

Point of observation

*2D image*

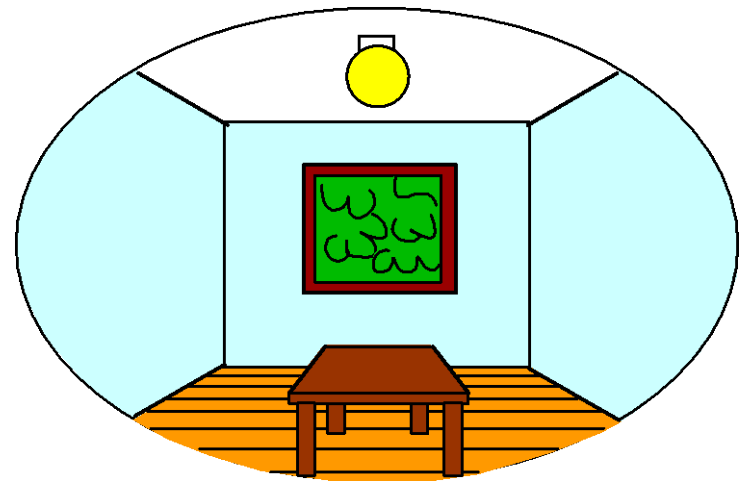

But there is a problem...

# Emission Theory of Vision

“For every complex problem there is an answer that is clear, simple, and wrong.”  
-- H. L. Mencken



Eyes send out “feeling rays” into the world

Supported by:

- Empedocles
- Plato
- Euclid (kinda)
- Ptolemy
- ...
- 50% of US college students\*

[\\*http://www.ncbi.nlm.nih.gov/pubmed/12094435?dopt=Abstract](http://www.ncbi.nlm.nih.gov/pubmed/12094435?dopt=Abstract)



# How we see the world

---

*3D world*

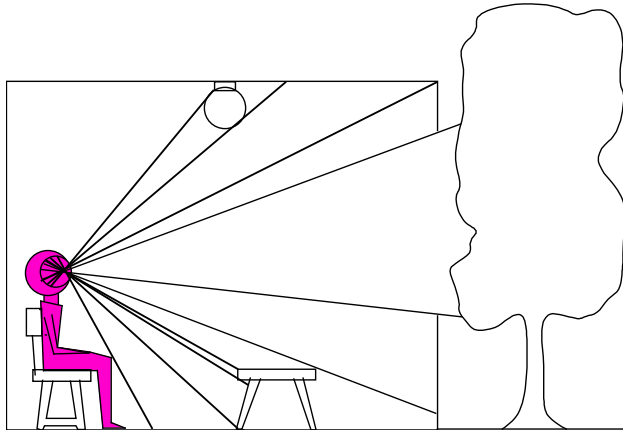

Point of observation

*2D image*

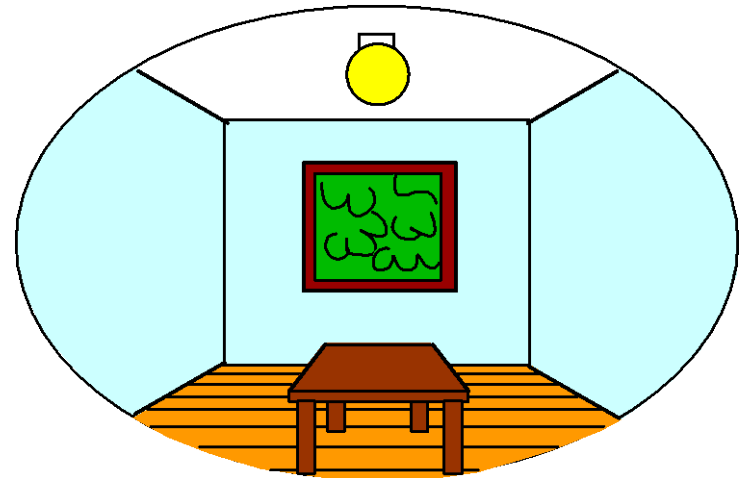



# How we see the world

---

*3D world*

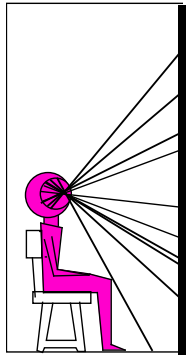

Painted  
backdrop

*2D image*

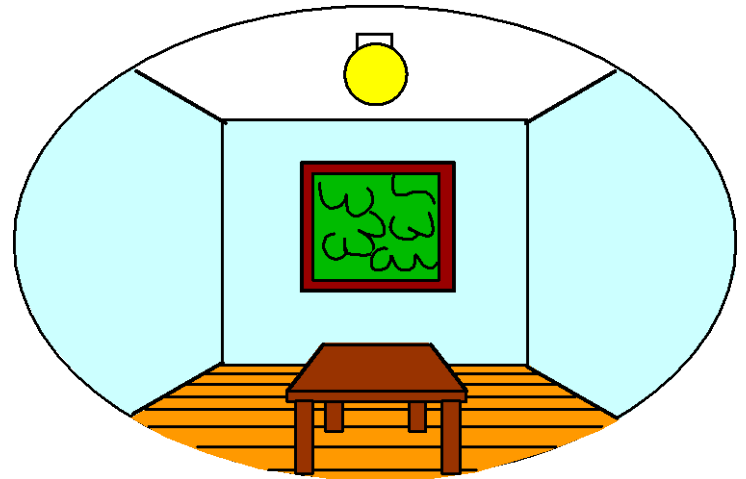

# Fooling the eye

---



CoolOpticalIllusions.com

JULIAN BEEVER

# Fooling the eye

---



Making of 3D sidewalk art: <http://www.youtube.com/watch?v=3SNYtd0Ayt0>

# Dimensionality Reduction Machine (3D to 2D)

---

*3D world*

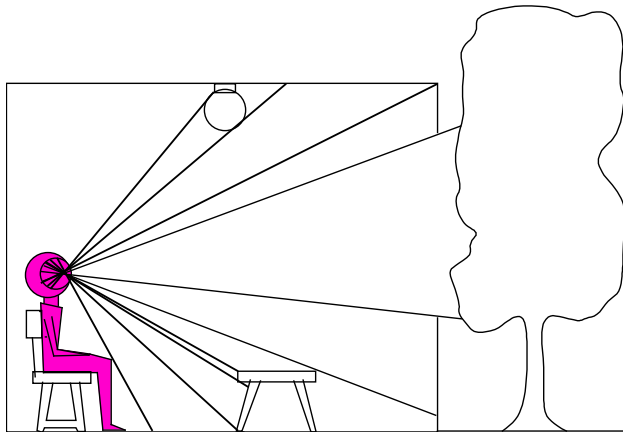

Point of observation

*2D image*

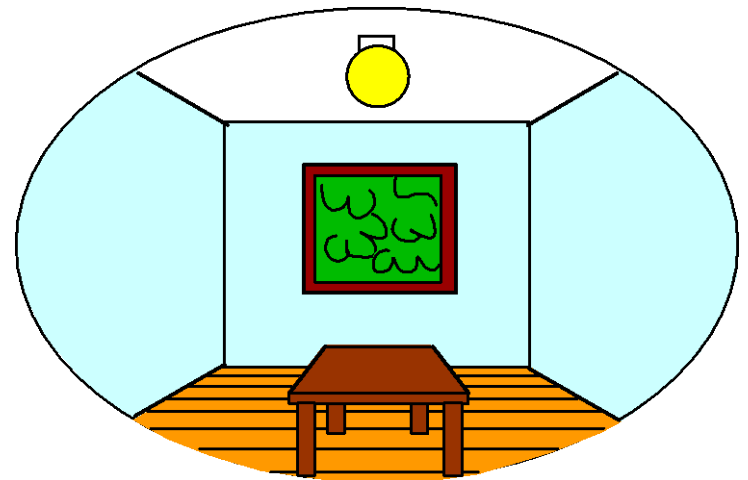

Why did evolution opt for such strange solution?

- Nice to have a passive, long-range sensor
- Can get 3D with stereo or by moving around, plus experience

# Dimensionality Reduction Machine (3D to 2D)

---

*3D world*

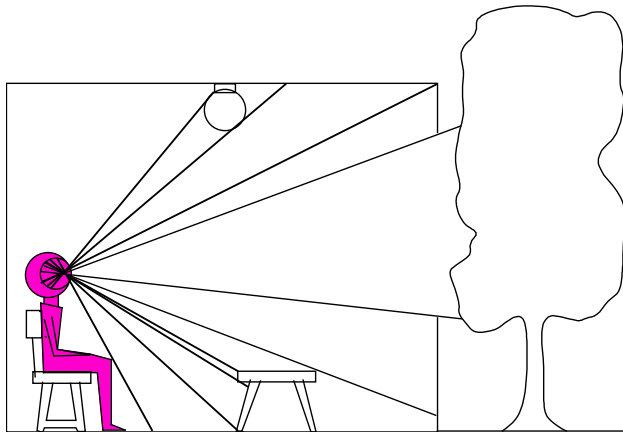

Point of observation

*2D image*

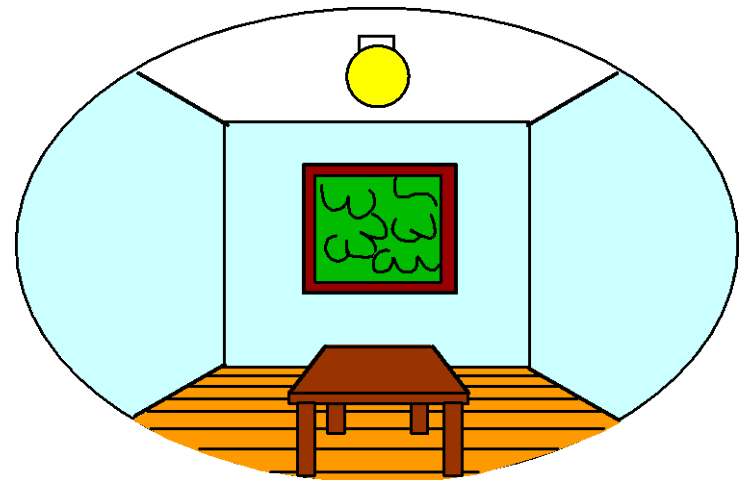

## What have we lost?

- Angles
- Distances (lengths)

# Funny things happen...

---

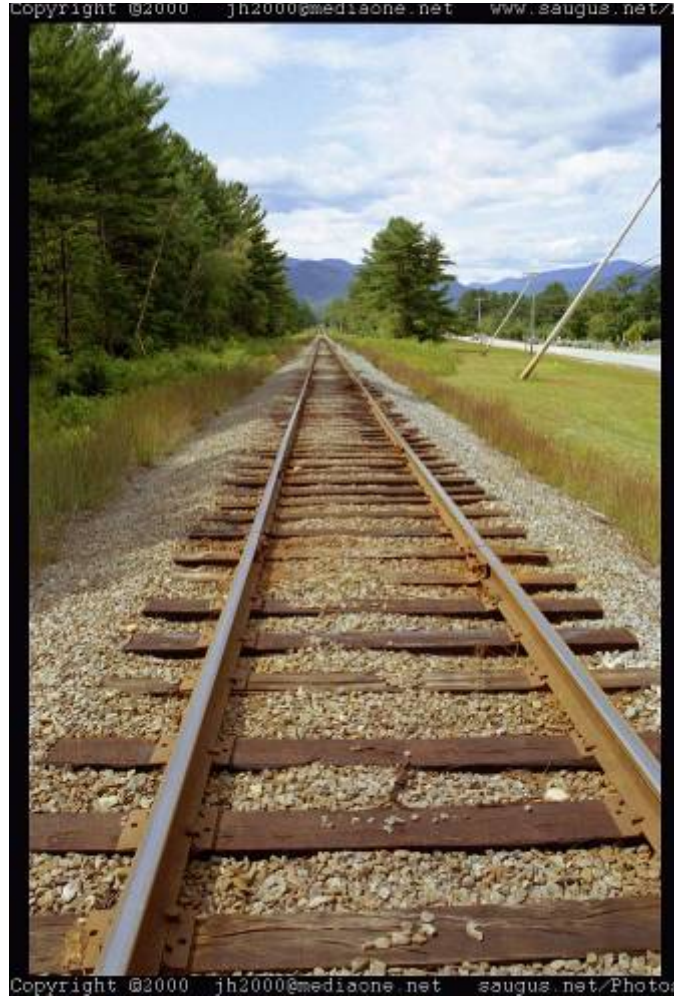

# Parallel lines aren't...

---

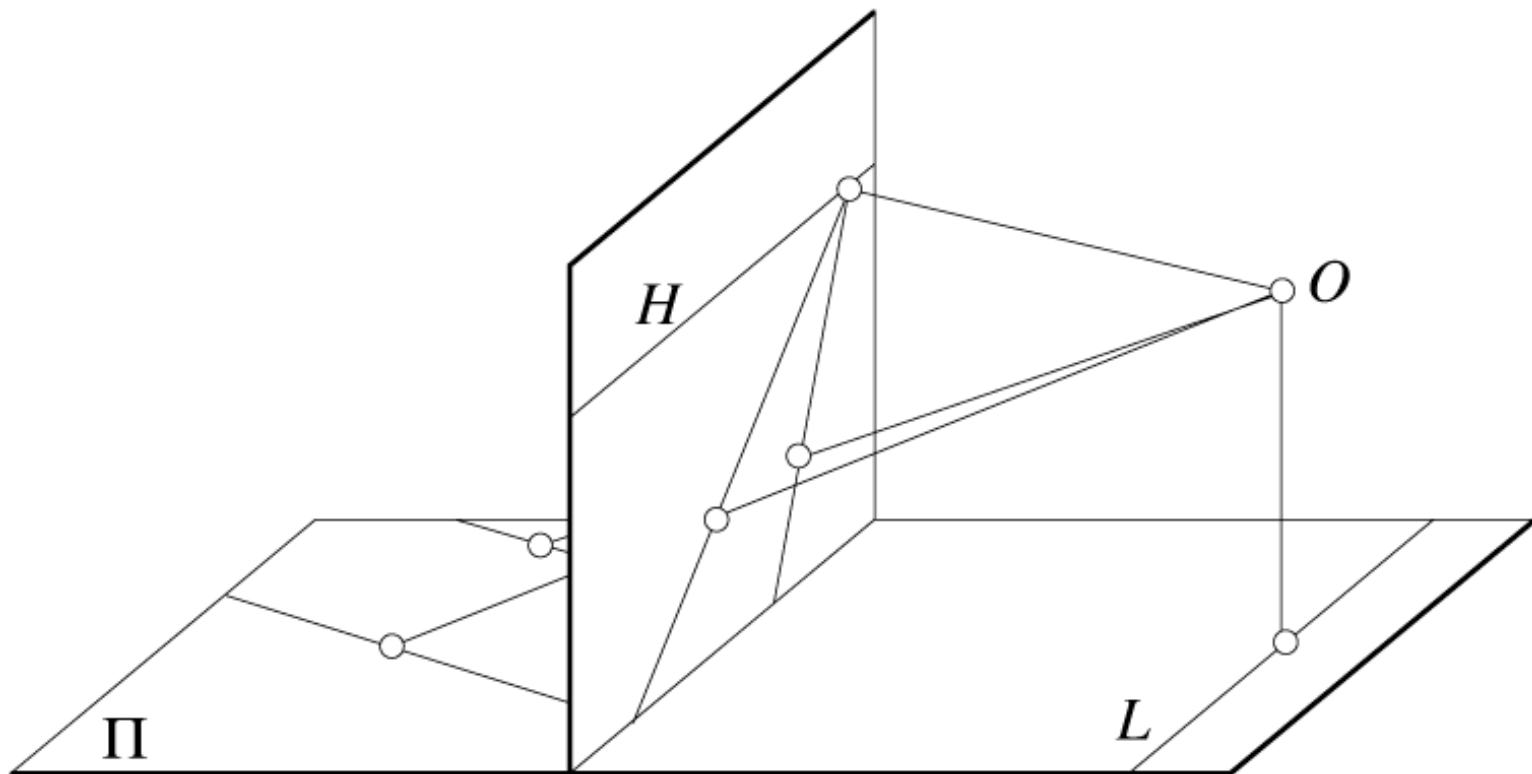

# Exciting New Study!



Sailors Take Warning



A.V. CLUB



VIDEO

POLITICS

SPORTS

BUSINESS

SCIENCE/TECH

ENTERTAINMENT

LOCAL

Q search

## RECENT NEWS

Ariel Castro Failed By System

New Skin Cream To Do Something

Assad Unable To Convince Putin That He Used Chemical Weapons On Syrians

Royal Baby Already Making New Friends

College-Aged Female Finds Unlikely Kindred Spirit In Audrey Hepburn

Personal Trainer Has Desk

Bruce Springsteen On Fence About Playing Assad's Birthday Gig

## Study: People Far Away From You Not Actually Smaller

NEWS • Science & Technology • ISSUE 49•34 • Aug 22, 2013



Researchers say that, contrary to prior assertions, the subject above stands at equal height at left and at right, and does not grow smaller as he walks away from the camera.



10.2K



688



332



# Lengths can't be trusted...

---

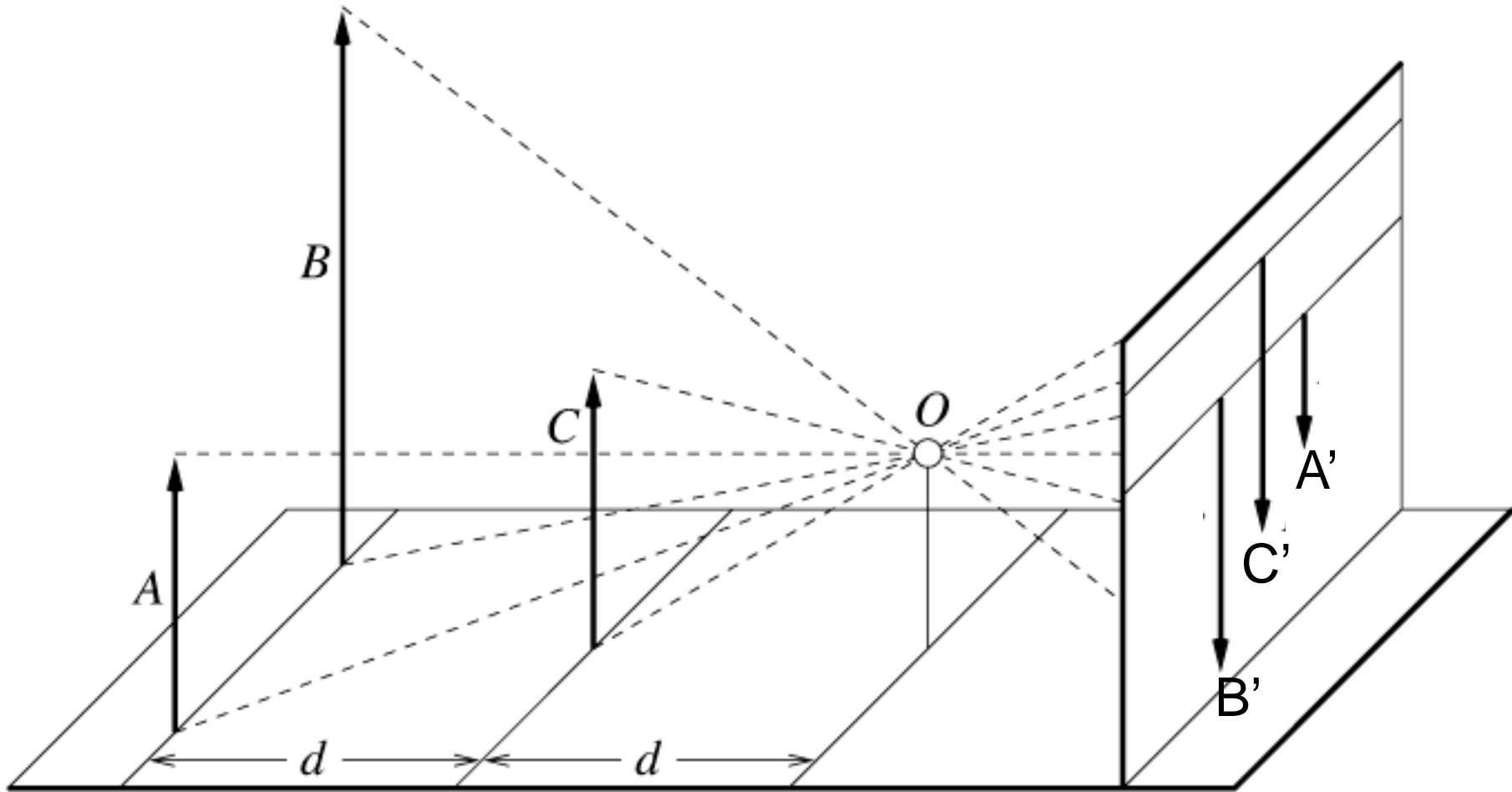

# ...but humans adopt!

---

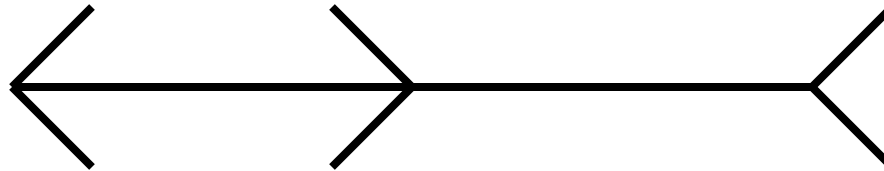

Müller-Lyer Illusion

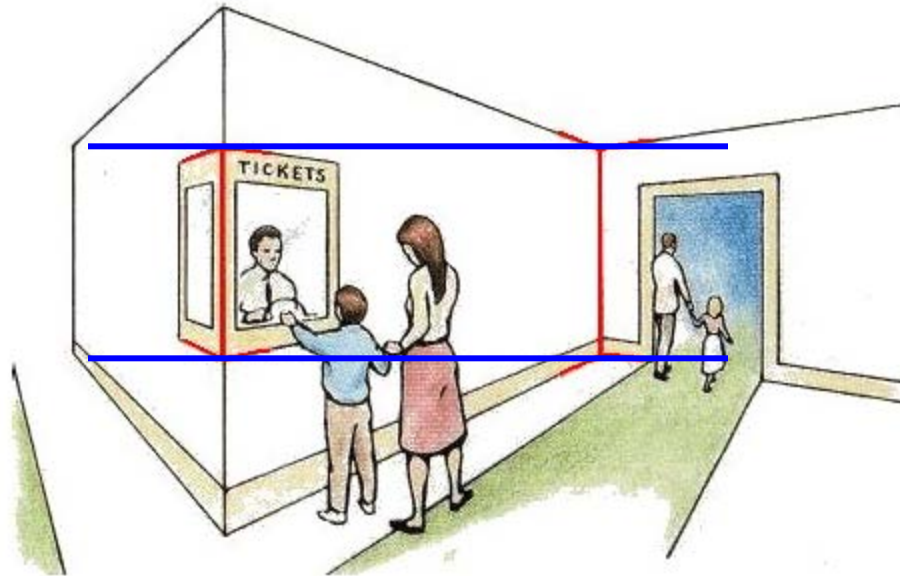

We don't make measurements in the image plane

# Modeling projection

---

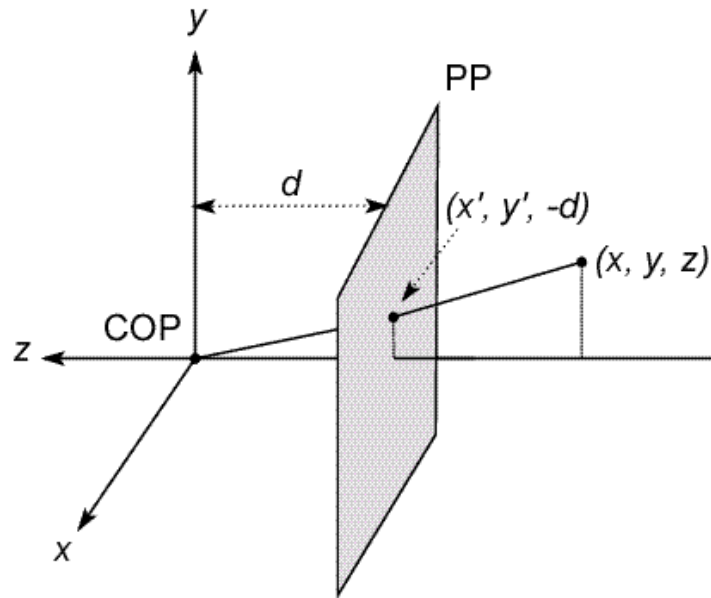

## The coordinate system

- We will use the pin-hole model as an approximation
- Put the optical center (**C**enter **O**f **P**rojection) at the origin
- Put the image plane (**P**rojection **P**lane) *in front* of the COP  
= Why?
- The camera looks down the *negative z axis*
  - we need this if we want right-handed-coordinates

# Modeling projection

---

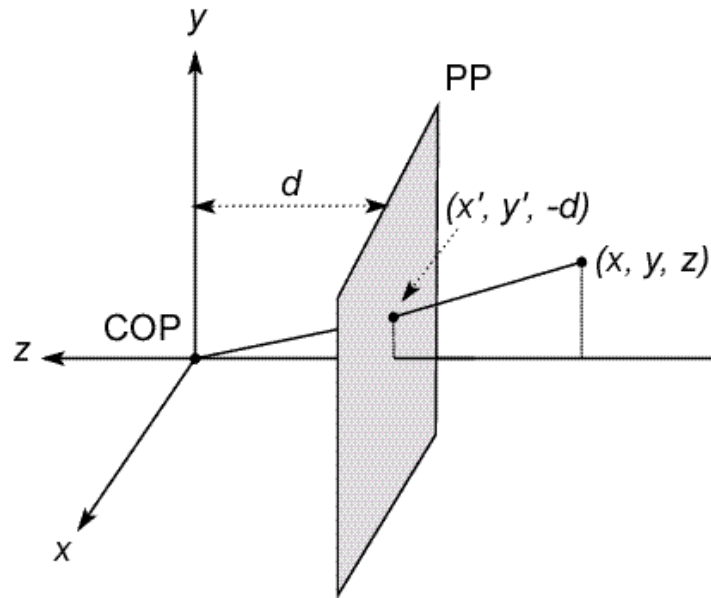

## Projection equations

- Compute intersection with PP of ray from (x,y,z) to COP
- Derived using similar triangles (on board)

$$(x, y, z) \rightarrow \left(-d\frac{x}{z}, -d\frac{y}{z}, -d\right)$$

- We get the projection by throwing out the last coordinate:

$$(x, y, z) \rightarrow \left(-d\frac{x}{z}, -d\frac{y}{z}\right)$$

# Orthographic Projection

---

## Special case of perspective projection

- Distance from the COP to the PP is infinite

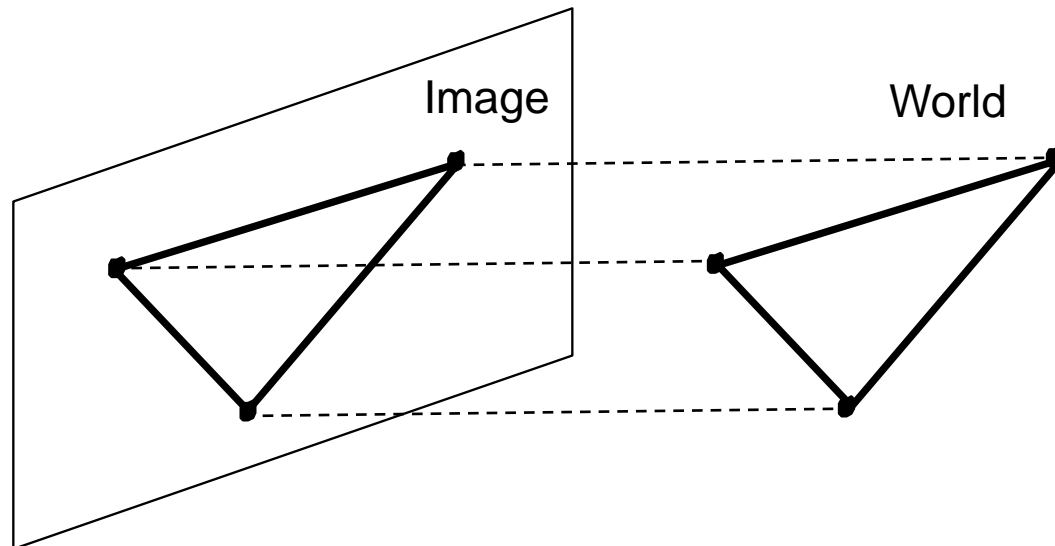

- Also called “parallel projection”
- $x' = x$
- $y' = y$

# Scaled Orthographic or “Weak Perspective”

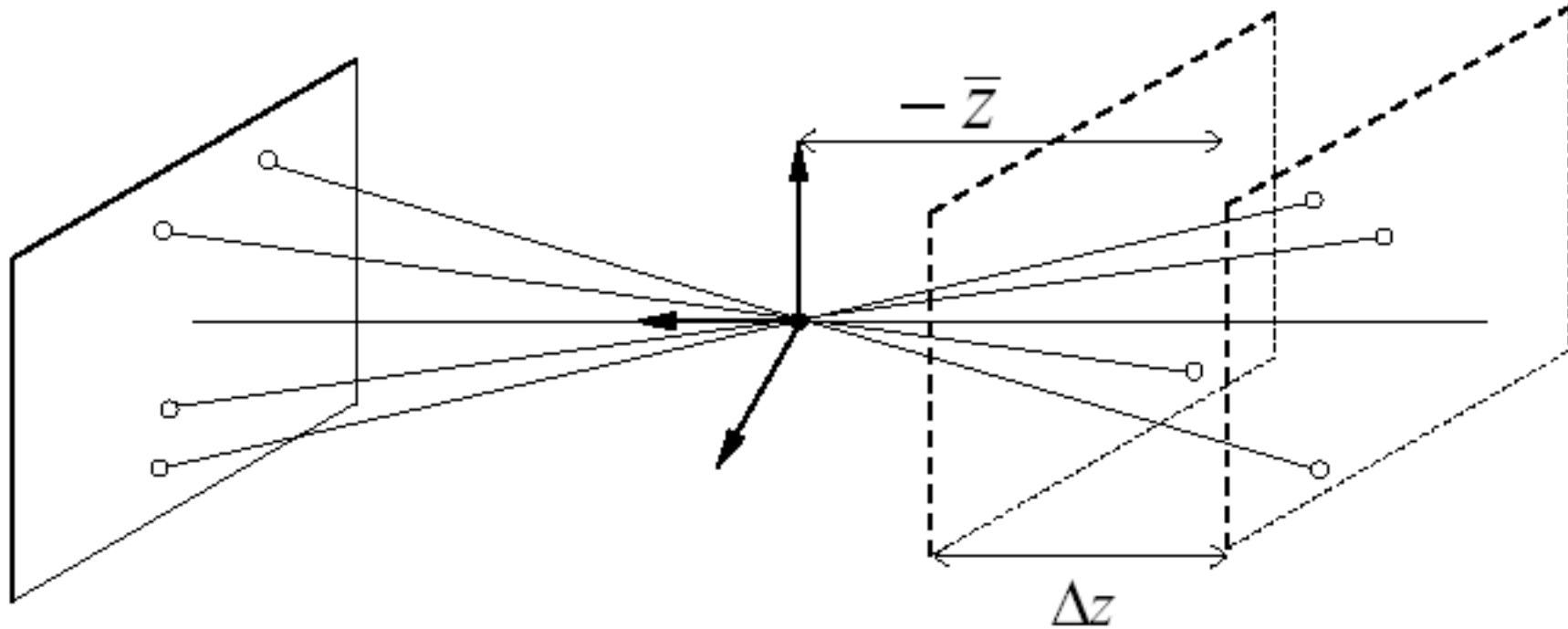

$$\text{If } \Delta z \ll -\bar{z} : \begin{aligned} x' &\approx -mx \\ y' &\approx -my \end{aligned} \quad m = -\frac{f}{\bar{z}}$$

Justified if scene depth is small relative to average distance from camera

# Scaled Orthographic or “Weak Perspective”

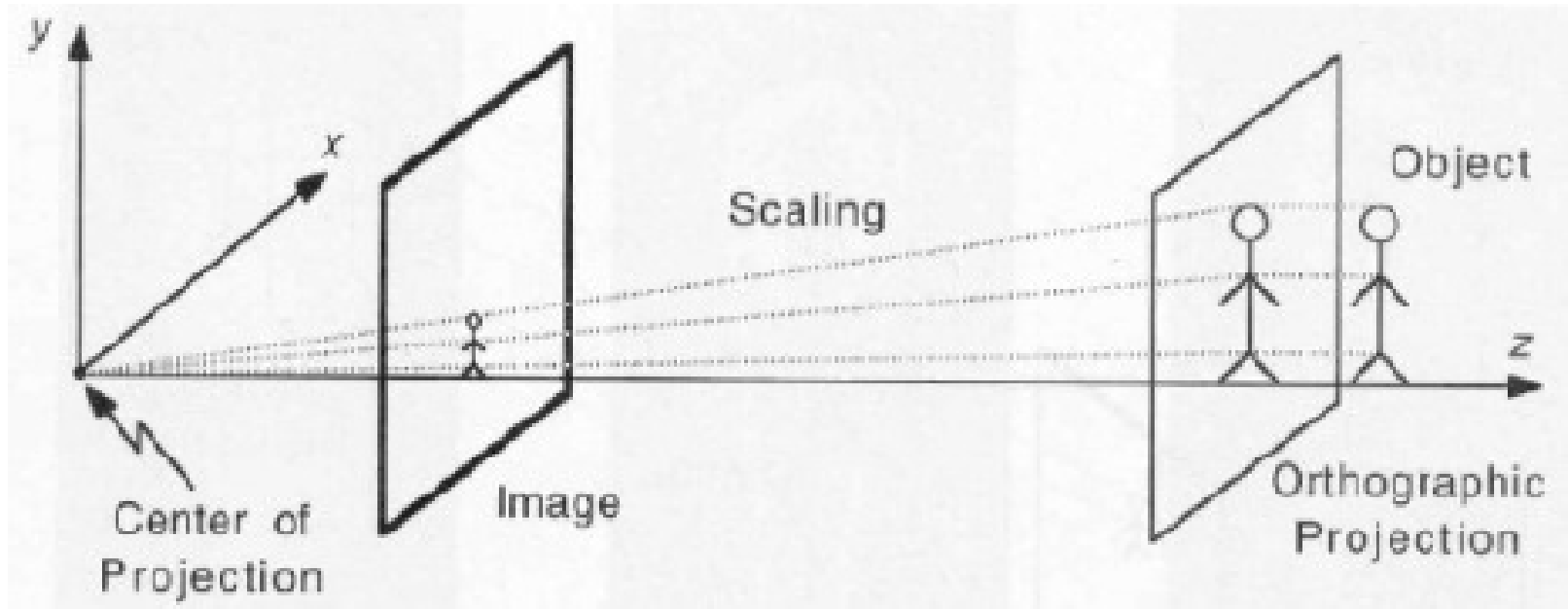

# Spherical Projection

---

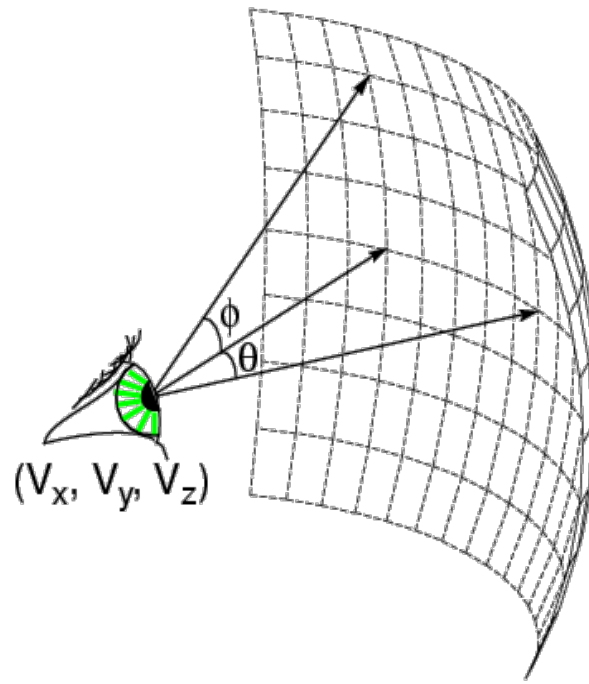

What if PP is spherical with center at COP?

In spherical coordinates, projection is trivial:

$$(\theta, \phi) = (\theta, \phi, d)$$

Note: doesn't depend on focal length  $f$ !



# Building a real camera

---



# Camera Obscura: the pre-camera

---

- First Idea: Mo-Ti, China (470-390 BC)
- First build: Al Hacen, Iraq/Egypt (965-1039 AD)
- Drawing aid for artists: described by Leonardo da Vinci (1452-1519)

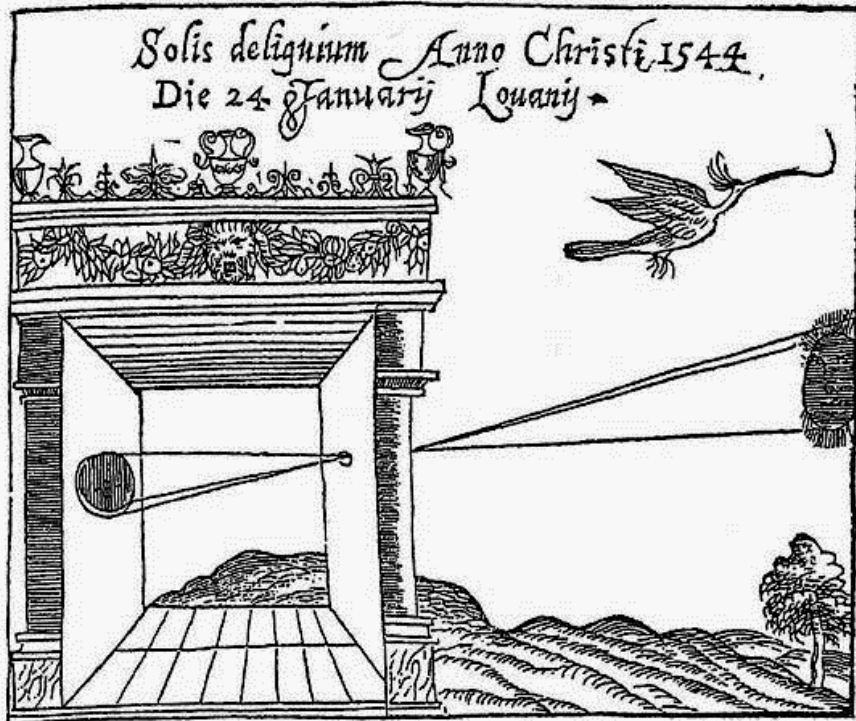

Gemma Frisius, 1558

# 8-hour exposure (Abelardo Morell)

---





# Pinhole cameras everywhere

---



Tree shadow during a solar eclipse

photo credit: Nils van der Burg

<http://www.physicstogo.org/index.cfm>



# Accidental pinhole cameras

---

My hotel room,  
contrast enhanced.



The view from my window



Accidental pinholes produce images that are  
unnoticed or misinterpreted as shadows

# Torralba and Freeman, CVPR'12

---

## Accidental pinhole camera









---

Window turned into a pinhole



View outside



# Pinspeck Camera: the anti-pinhole

---

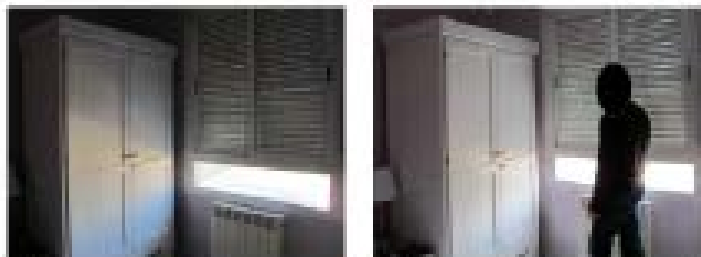
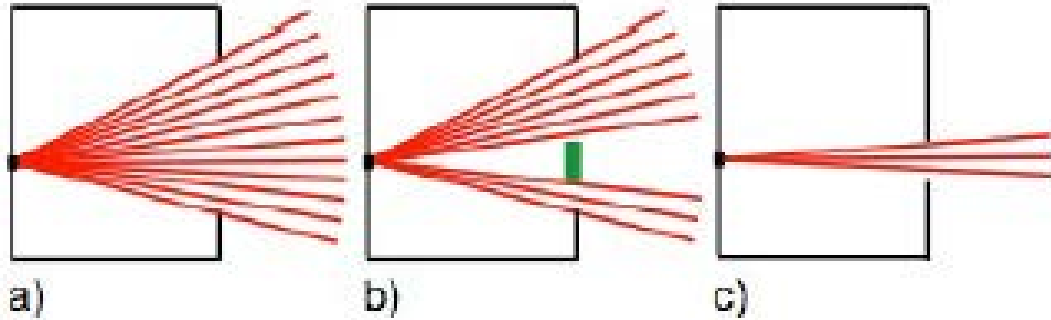

a)

b)

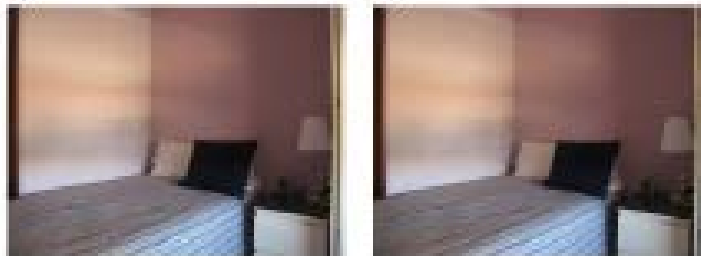

c)

d)



a) Difference image

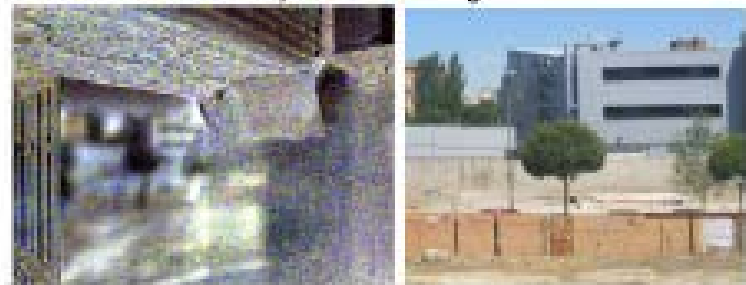

b) Difference upside down

c) True outdoor view

# Project 2: a Shoe-box Camera Obscura

---

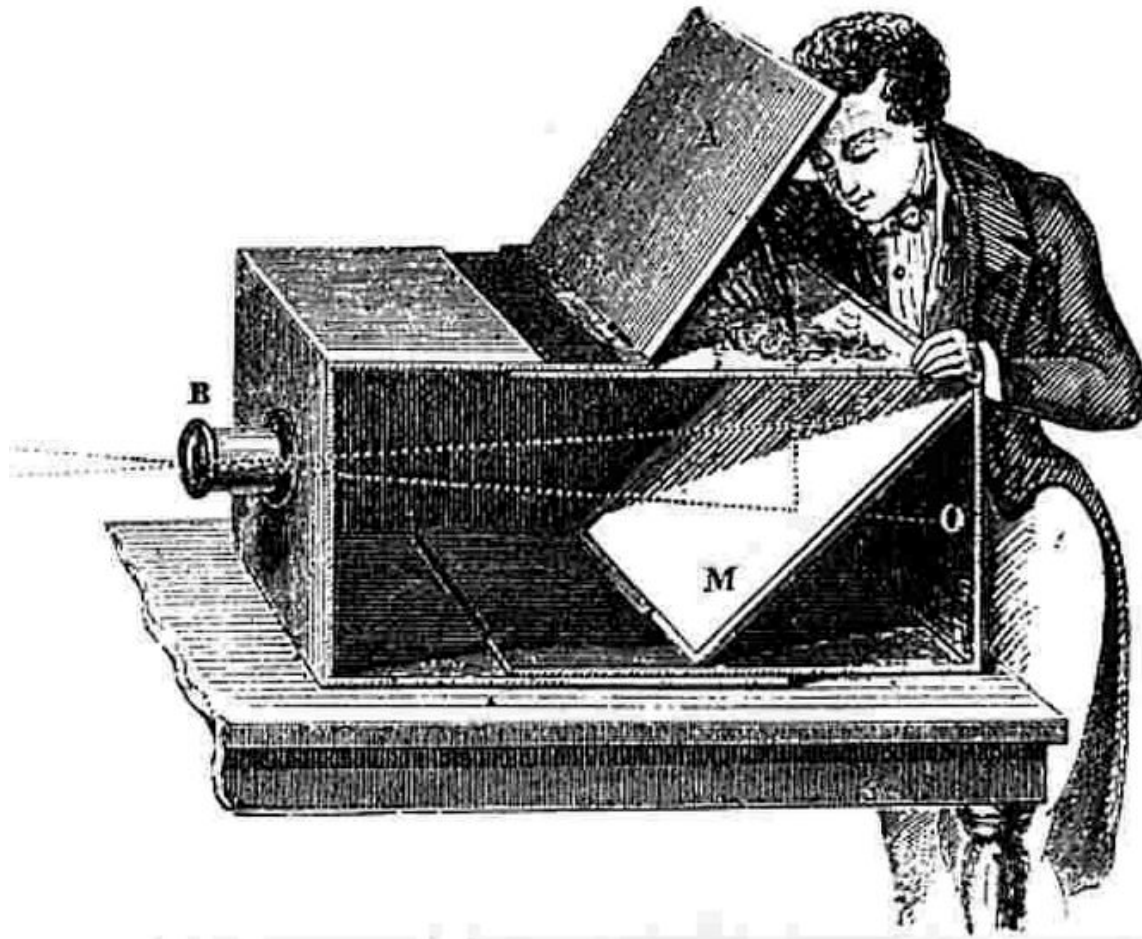

# Another way to make pinhole camera

---



Why so  
blurry?

# Shrinking the aperture

---

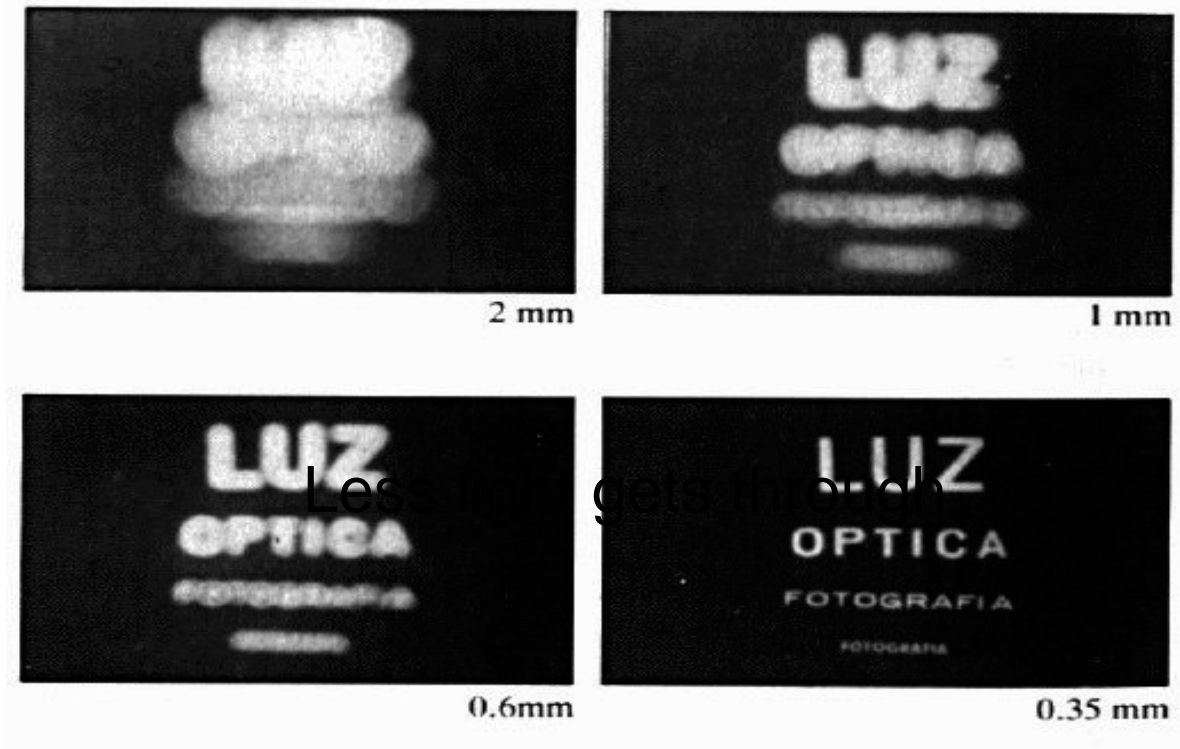

Why not make the aperture as small as possible?

- Less light gets through
- Diffraction effects...

# Shrinking the aperture

---

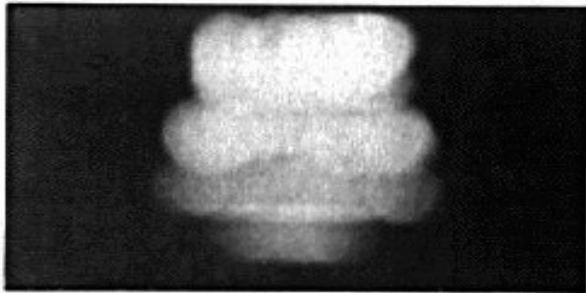

2 mm

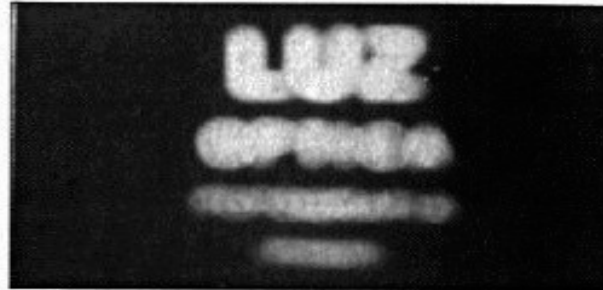

1 mm



0.6mm



0.35 mm



0.15 mm



0.07 mm

# The reason for lenses

---

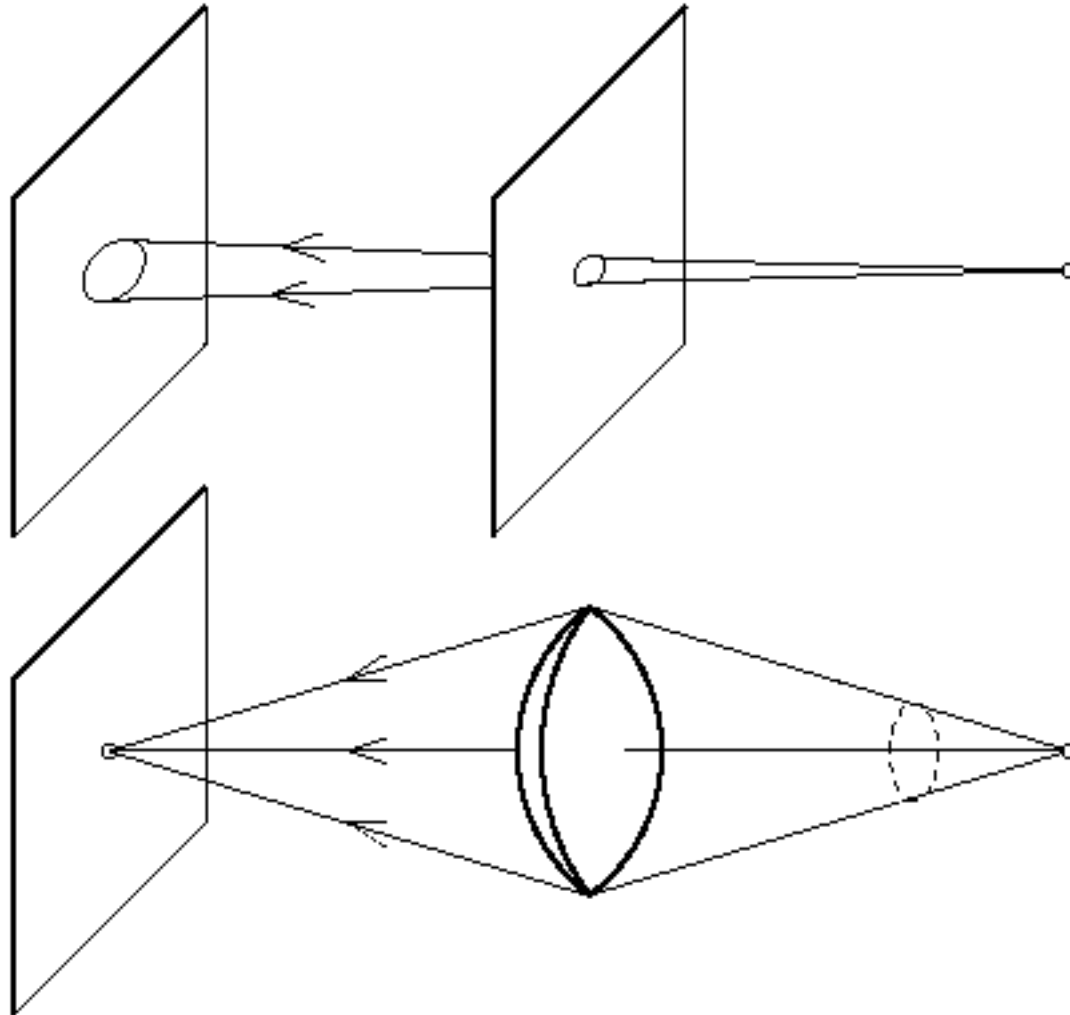



---

Focus

# Focus and Defocus

---

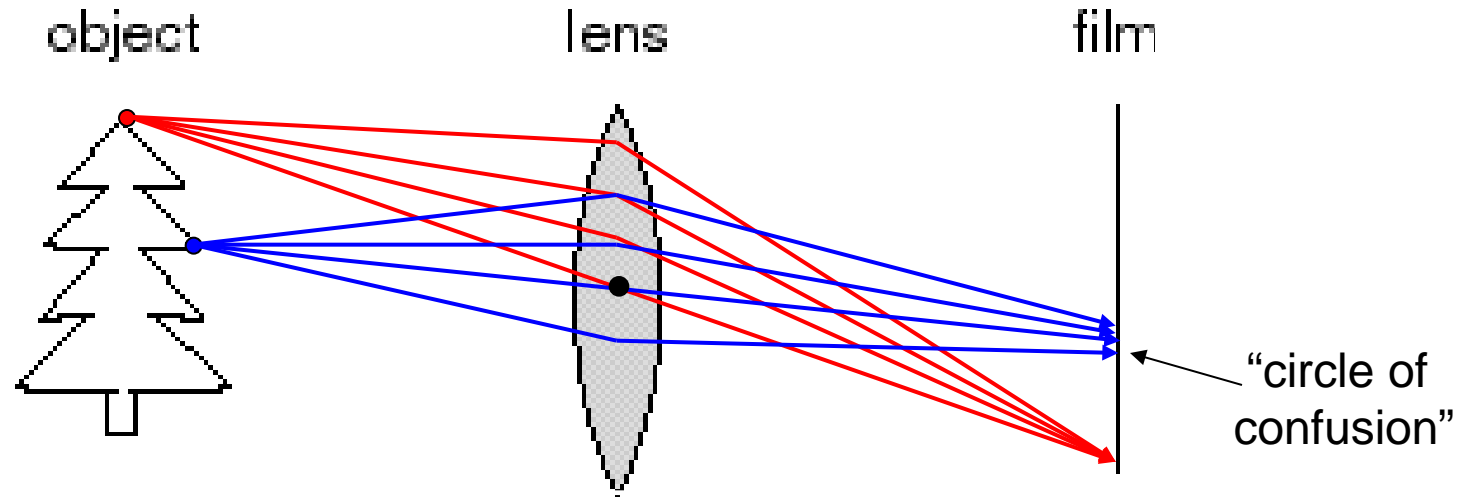

## A lens focuses light onto the film

- There is a specific distance at which objects are “in focus”
  - other points project to a “circle of confusion” in the image
- Changing the shape of the lens changes this distance

# Thin lenses

---

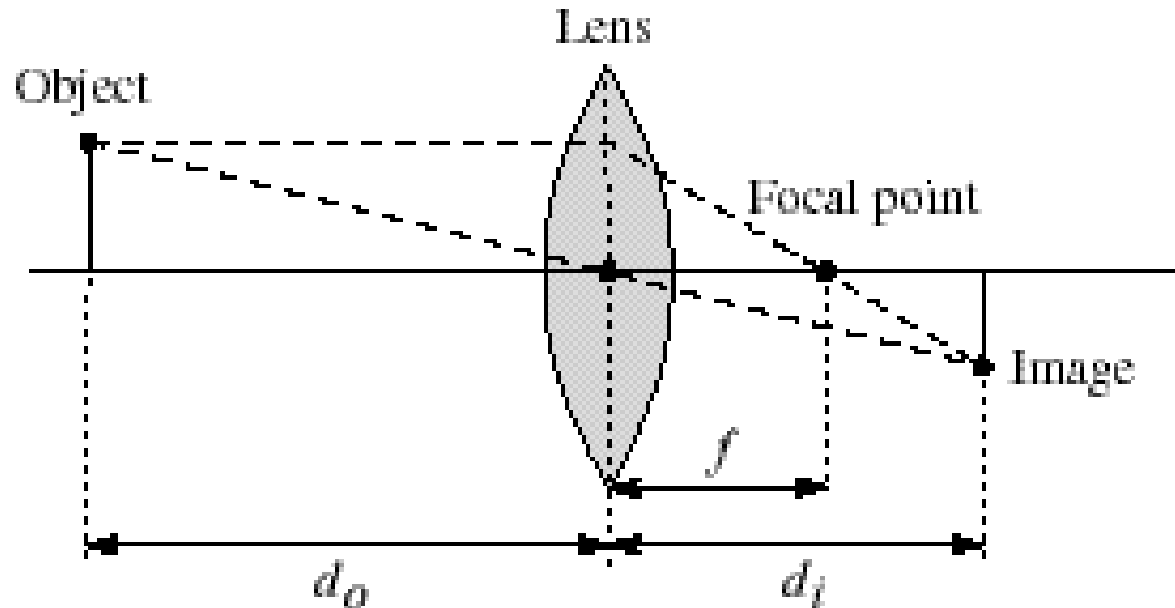

Thin lens equation: 
$$\frac{1}{d_o} + \frac{1}{d_i} = \frac{1}{f}$$

- Any object point satisfying this equation is in focus
- What is the shape of the focus region?
- Thin lens applet: [http://www.phy.ntnu.edu.tw/java/Lens/lens\\_e.html](http://www.phy.ntnu.edu.tw/java/Lens/lens_e.html) (by Fu-Kwun Hwang )

# Varying Focus

---



---

# Depth Of Field

# Depth of Field

---

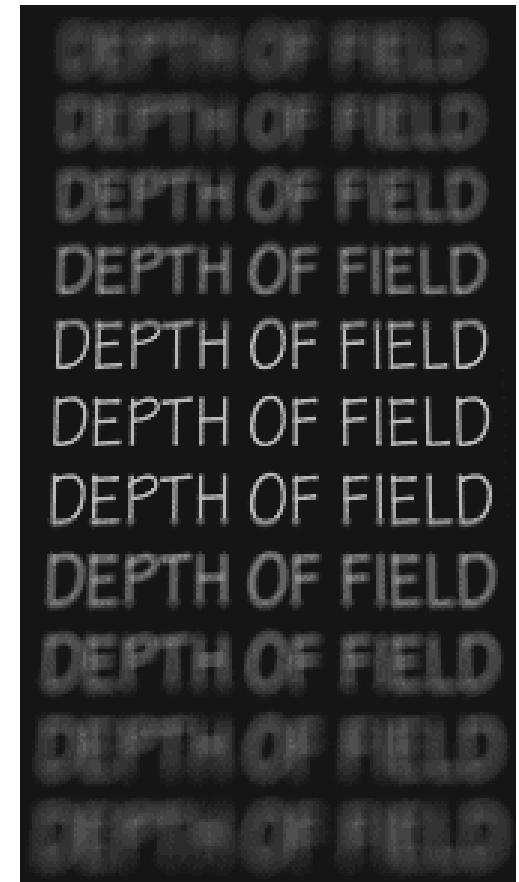

# Aperture controls Depth of Field

---

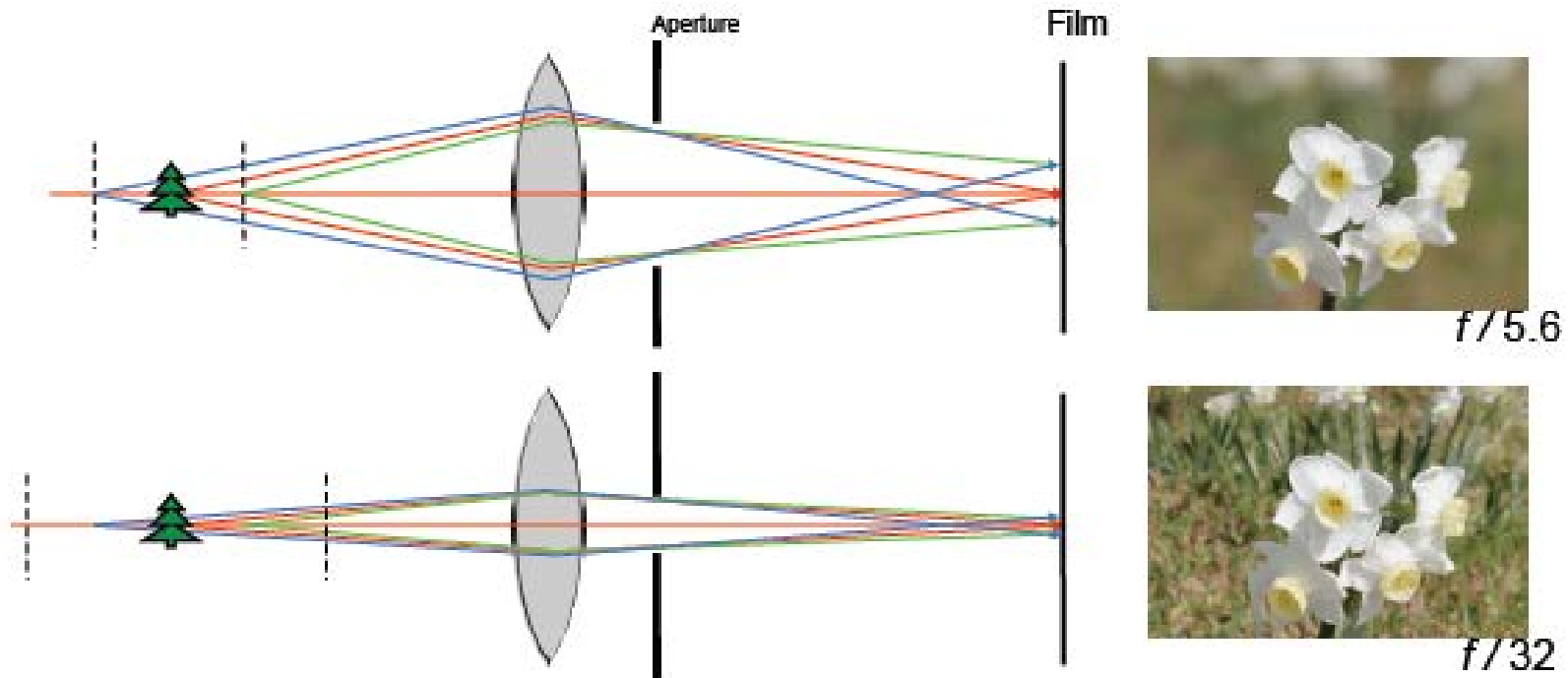

## Changing the aperture size affects depth of field

- A smaller aperture increases the range in which the object is approximately in focus
- But small aperture reduces amount of light – need to increase exposure

F-number: focal length / aperture diameter

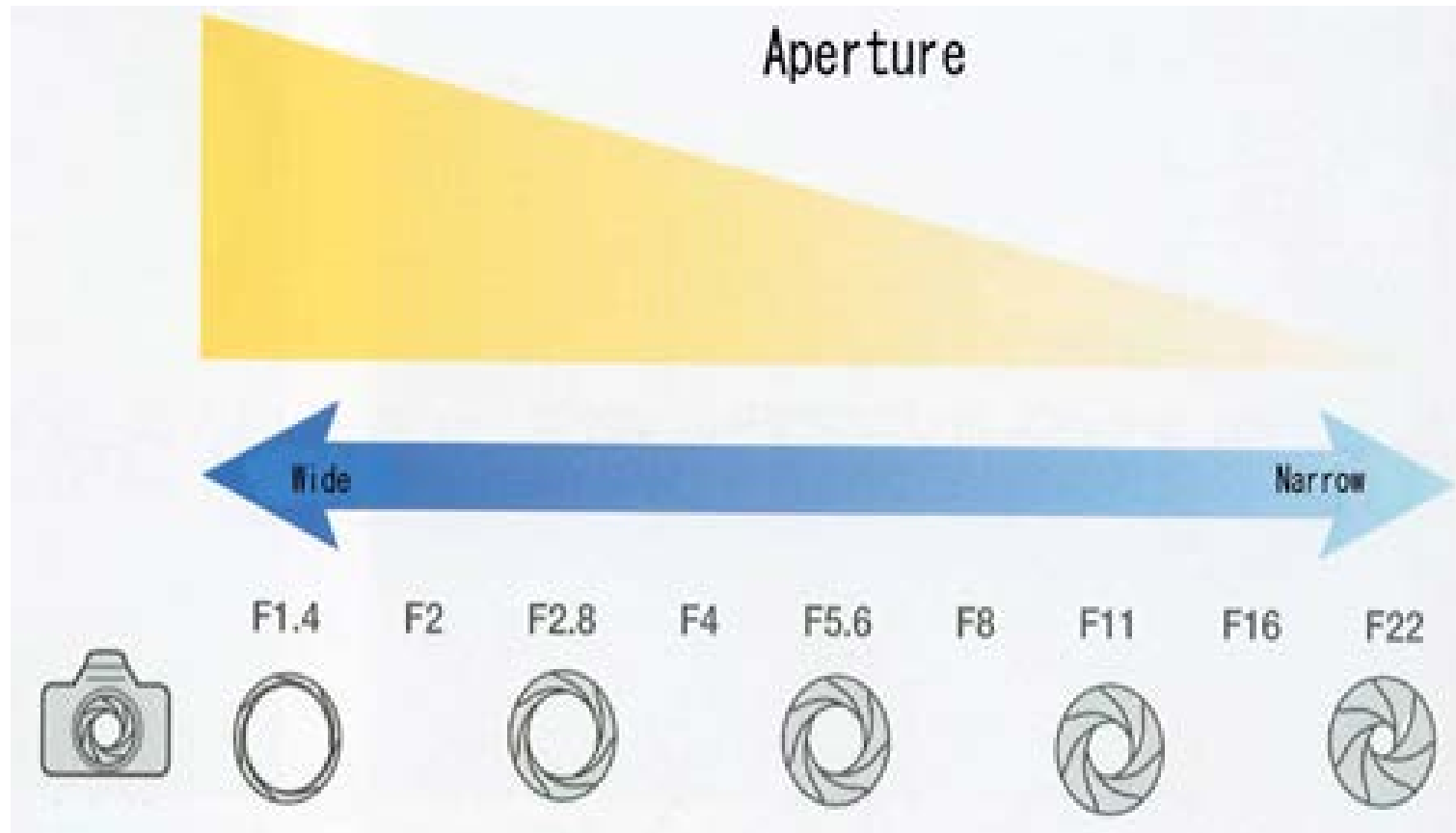



# Varying the aperture



Wide aperture = small DOF



Narrow aperture = large DOF

# Nice Depth of Field effect

---



---

# Field of View (Zoom)

# Field of View (Zoom)

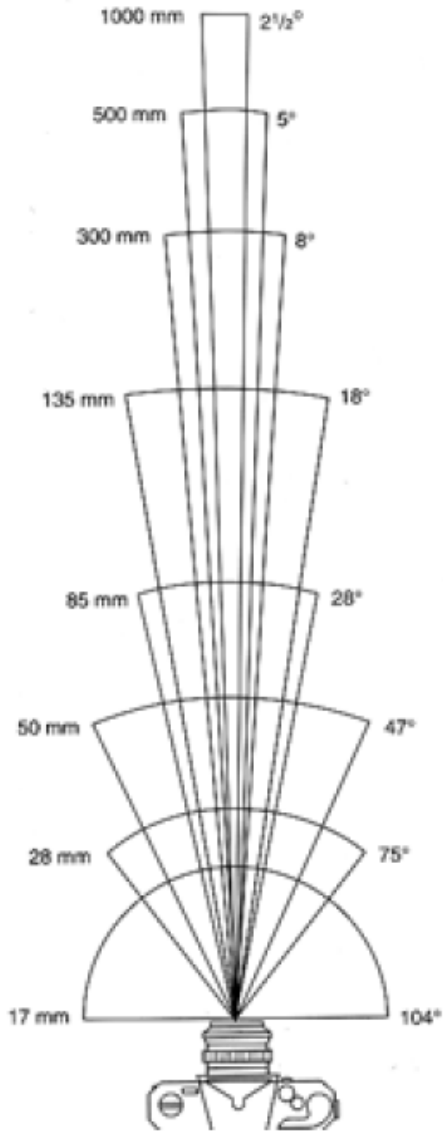

17mm



28mm



50mm



85mm

**From London and Upton**

# Field of View (Zoom) = Cropping

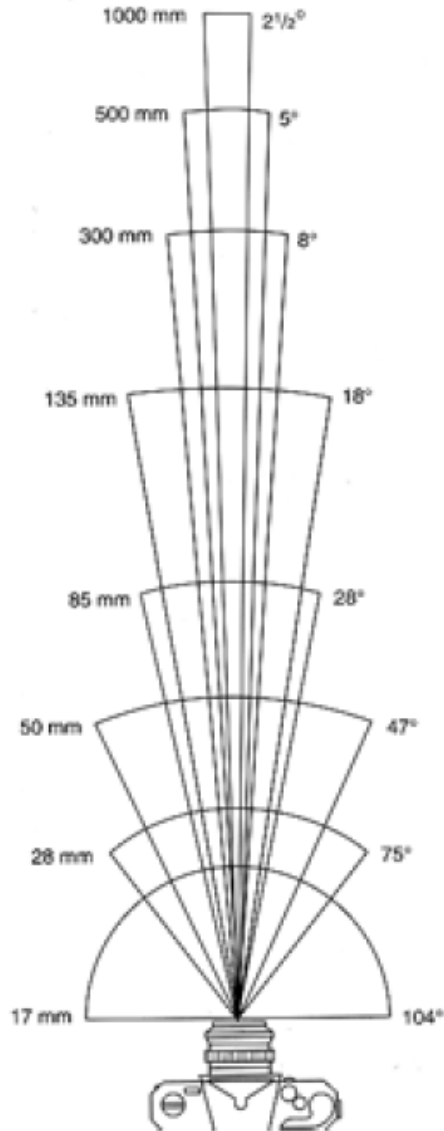

135mm

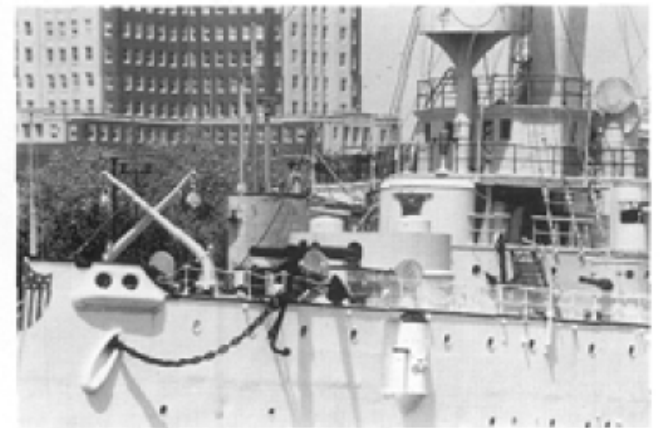

300mm



500mm



1000mm

**From London and Upton**

# FOV depends of Focal Length

---

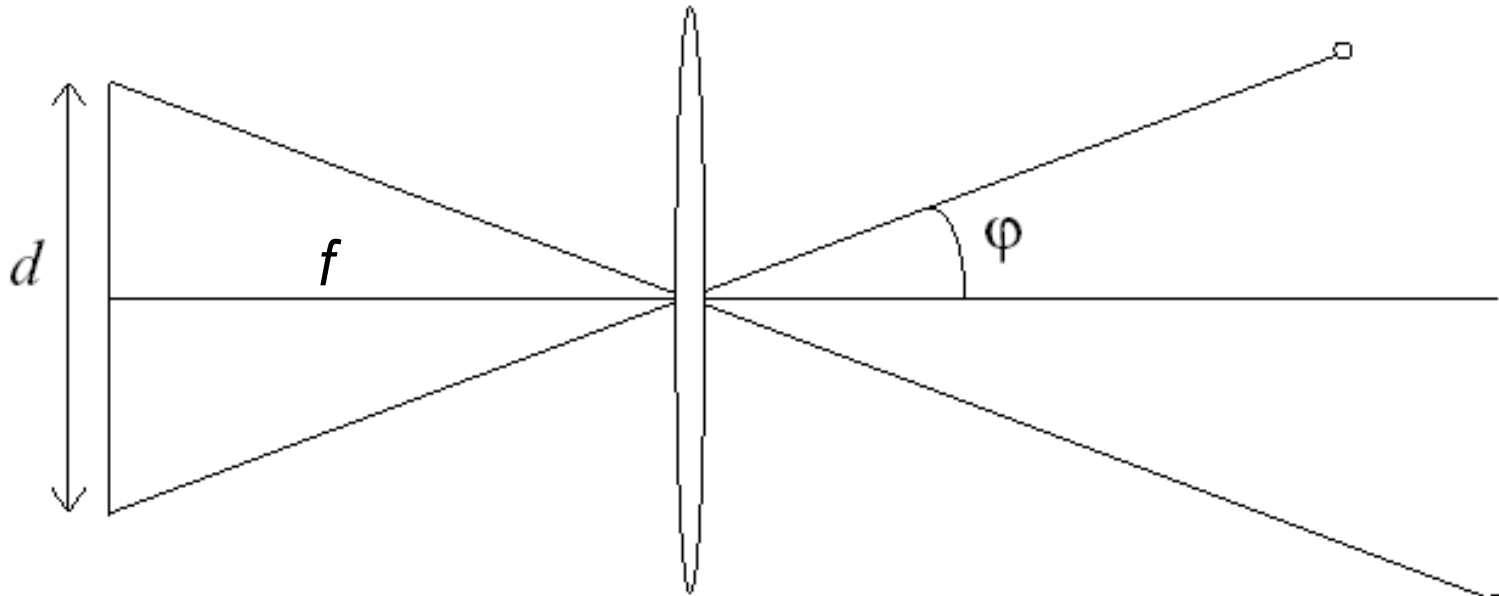

Size of field of view governed by size of the camera retina:

$$\varphi = \tan^{-1}\left(\frac{d}{2f}\right)$$

Smaller FOV = larger Focal Length

# Expensive toys...

---



**Sigma 200-500mm F2.8 EX DG lens**

*What does 1600mm lens look like?*

<http://www.digitalpixels.net/varia/the-web/sigma-200-500mm-f28-ex-dg-lens-on-the-field/>



[http://dancarrphotography.com/blog/wp-content/uploads/2011/05/Canon\\_super\\_tele\\_comparison.jpg](http://dancarrphotography.com/blog/wp-content/uploads/2011/05/Canon_super_tele_comparison.jpg)



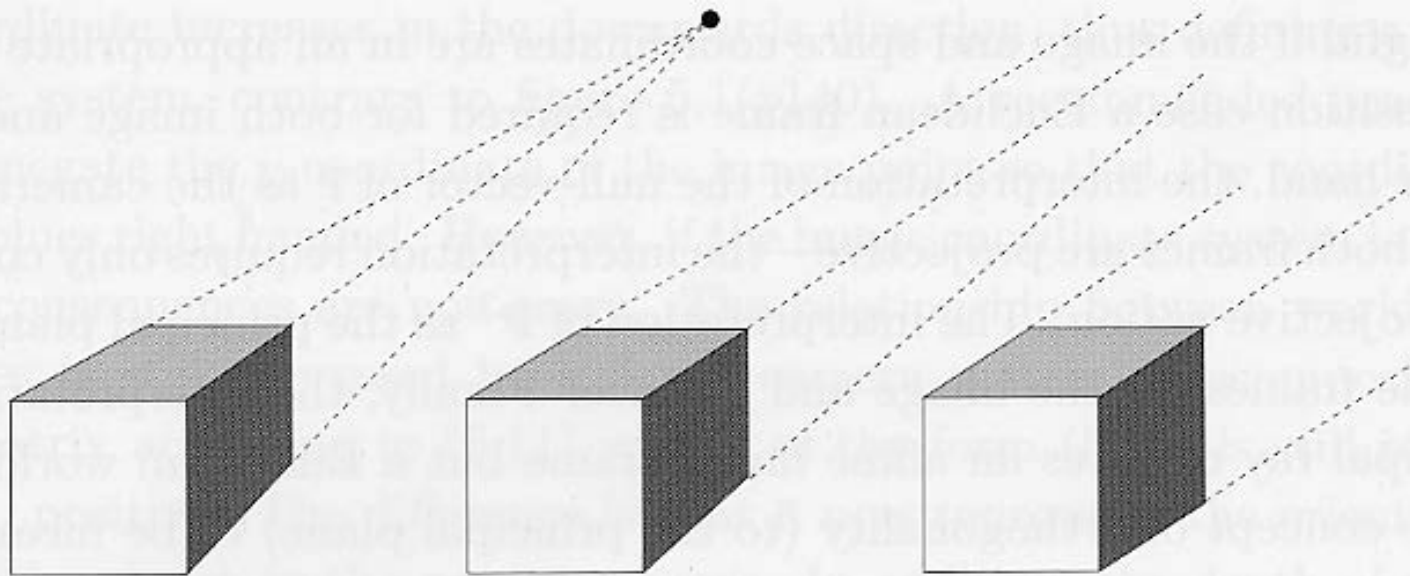

perspective

weak perspective

————— increasing focal length —————>

————— increasing distance from camera —————>

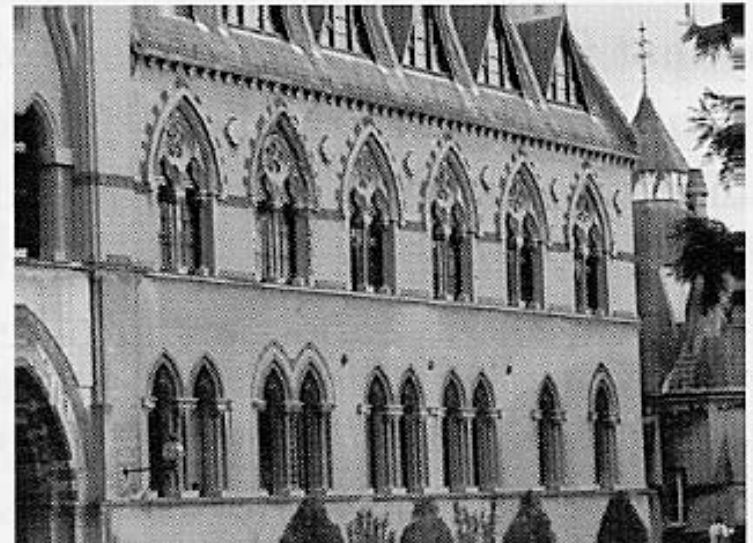
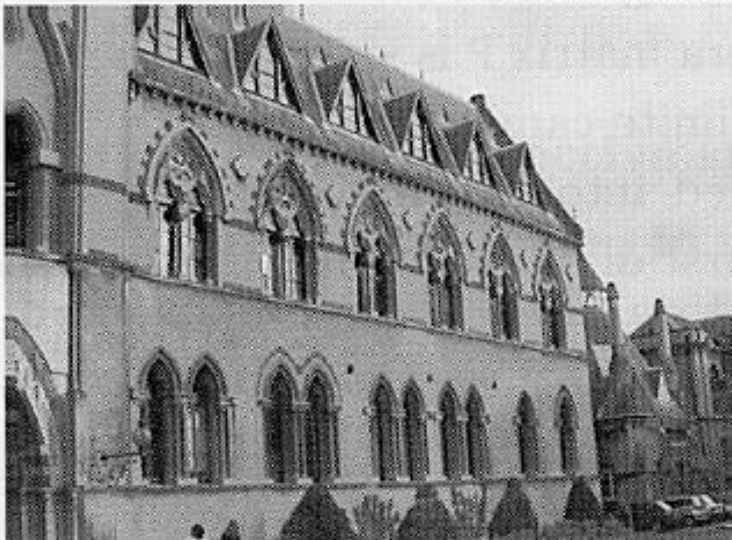

From Zisserman & Hartley



# Field of View / Focal Length

---



Large FOV, small  $f$   
Camera close to car



Small FOV, large  $f$   
Camera far from the car

# Fun with Focal Length (Jim Sherwood)

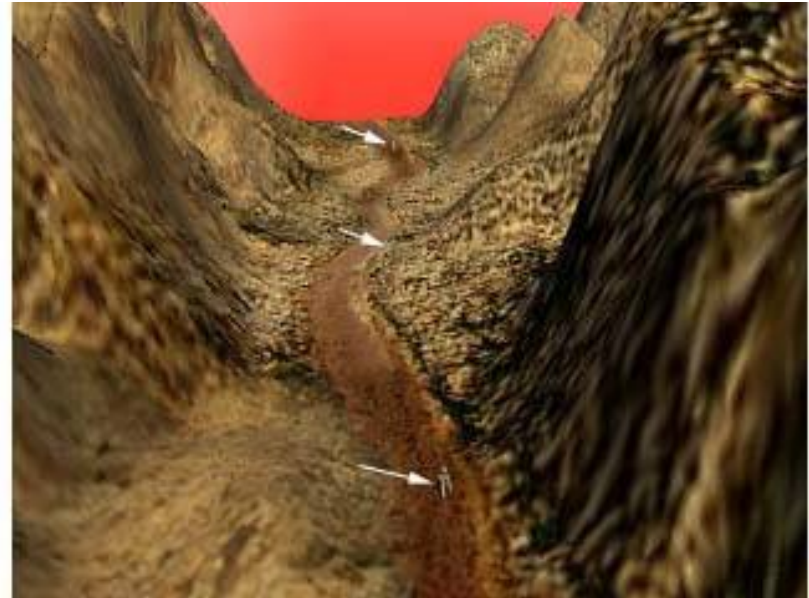

<http://www.hash.com/users/jsherwood/tutes/focal/Zoomin.mov>



Figure 5.1

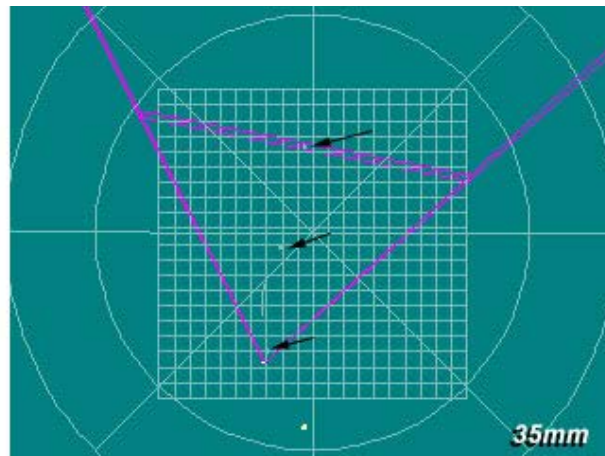

Figure 5.2

# Dolly Zoom (“Vertigo Shot”)

---

[http://filmmakermagazine.com/83872-hitchcock-to-scorcese-47-years-of-the-dolly-zoom/#.VBNtn\\_IdVac](http://filmmakermagazine.com/83872-hitchcock-to-scorcese-47-years-of-the-dolly-zoom/#.VBNtn_IdVac)

# Shutter Speed

---



# Exposure: shutter speed vs. aperture

---

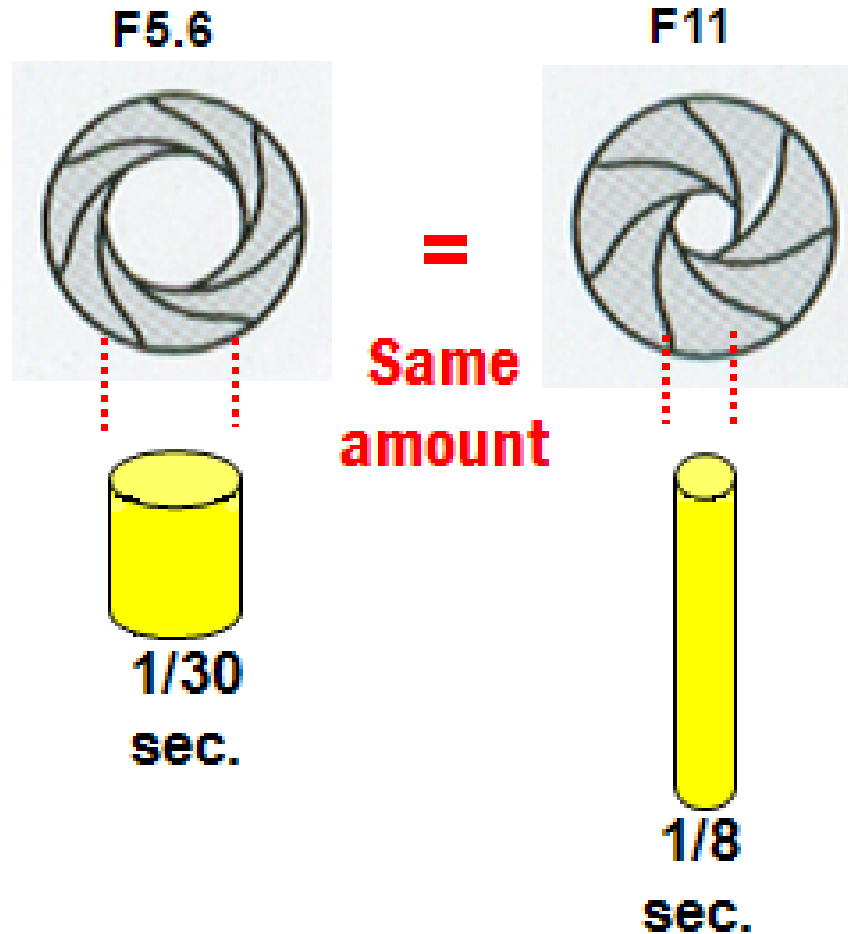







# Fun with slow shutter speeds

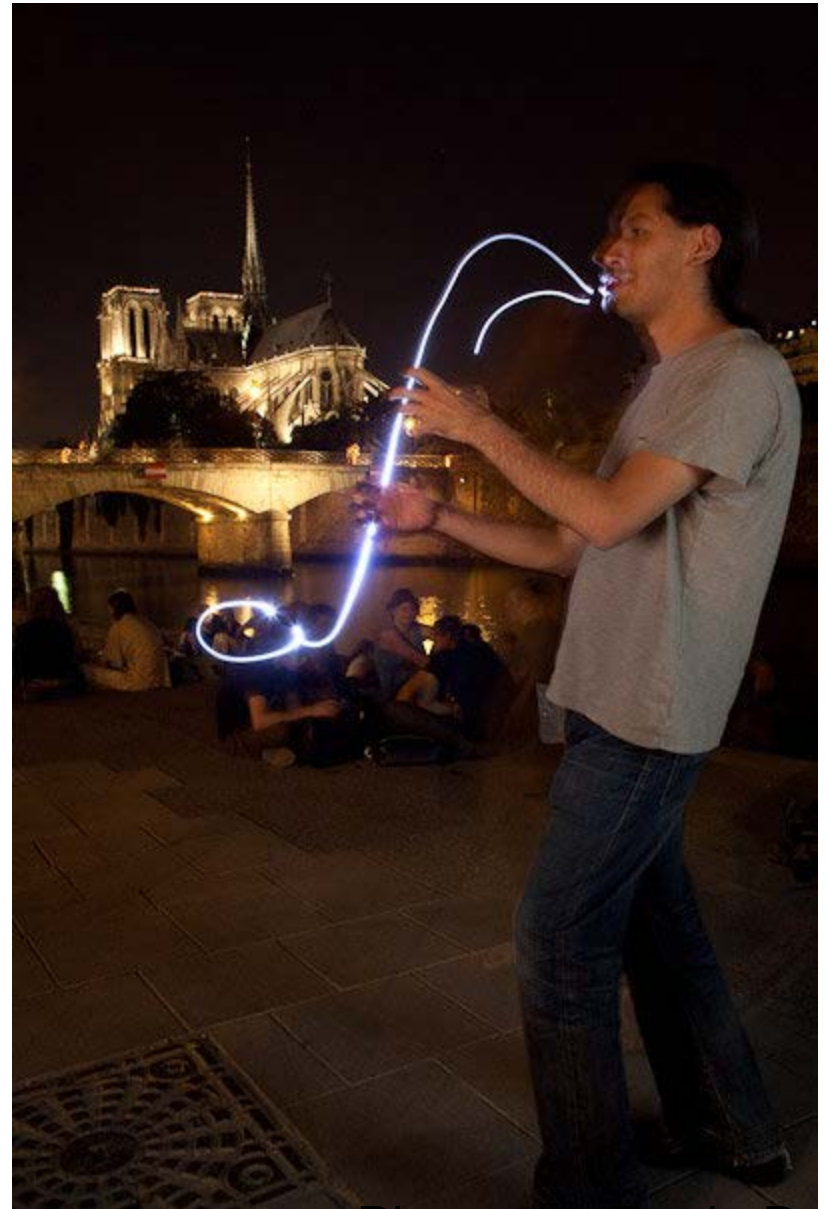

Photos by Fredo Durand

# More fun

---



<http://vimeo.com/14958082>



---

# Lens Flaws

# Lens Flaws: Chromatic Aberration

---

Dispersion: wavelength-dependent refractive index

- (enables prism to spread white light beam into rainbow)

Modifies ray-bending and lens focal length:  $f(\lambda)$

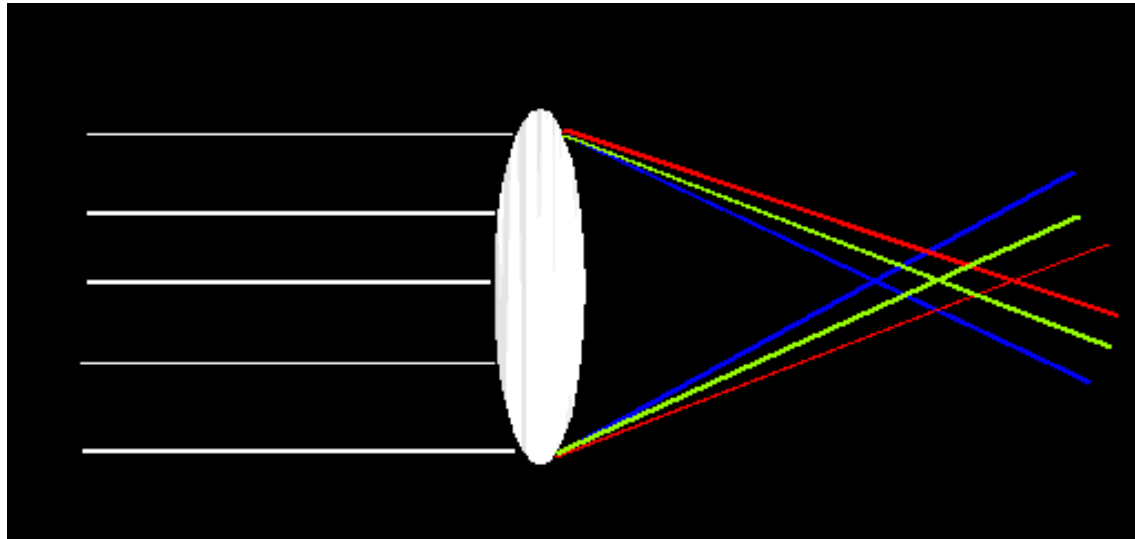

color fringes near edges of image

Corrections: add 'doublet' lens of flint glass, etc.

# Chromatic Aberration

---

Near Lens Center



Near Lens Outer Edge

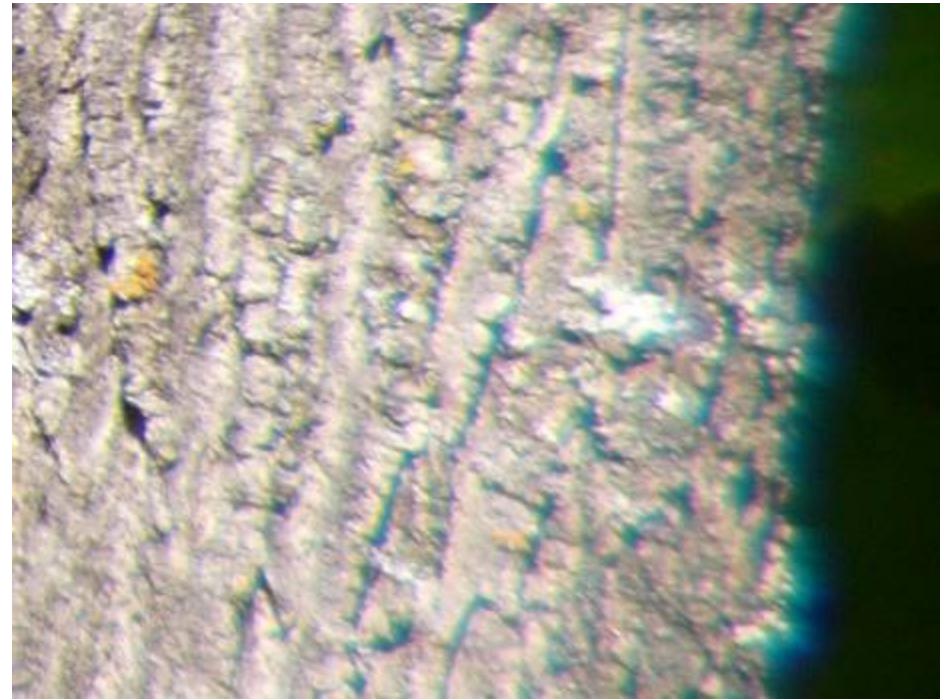

# Radial Distortion (*e.g.* 'Barrel' and 'pin-cushion')

---

straight lines curve around the image center



# Radial Distortion

---

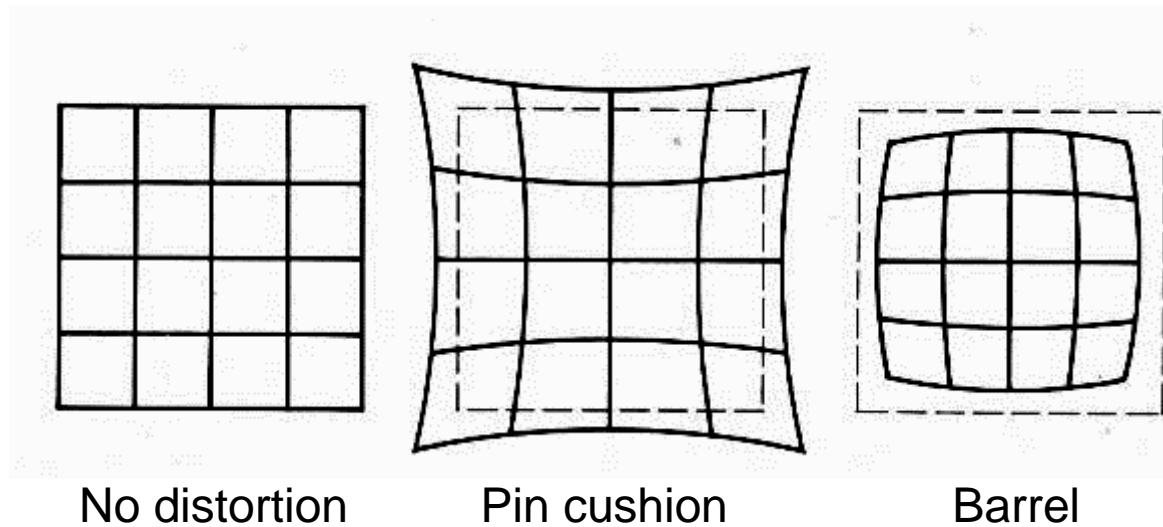

## Radial distortion of the image

- Caused by imperfect lenses
- Deviations are most noticeable for rays that pass through the edge of the lens

# Radial Distortion

