

Lecture #5

OUTLINE

- Node Analysis, examples
- Node Analysis with dependent sources
- Mesh Analysis

Reading

Chapter 2

Nodal Analysis: Example #1

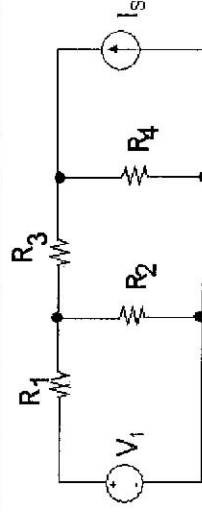

1. Choose a reference node.
2. Define the node voltages (except reference node and the one set by the voltage source).
3. Apply KCL at the nodes with unknown voltage.
4. Solve for unknown node voltages.

Node-Voltage Circuit Analysis Method

1. **Choose a reference node** ("ground")
Look for the one with the most connections!
2. **Define unknown node voltages**
those which are not fixed by voltage sources
3. **Write KCL at each unknown node**, expressing current in terms of the node voltages (using the i - v relationships of branch elements)
Special cases: floating voltage sources
4. **Solve the set of independent equations**
 N equations for N unknown node voltages

Nodal Analysis: Example #2

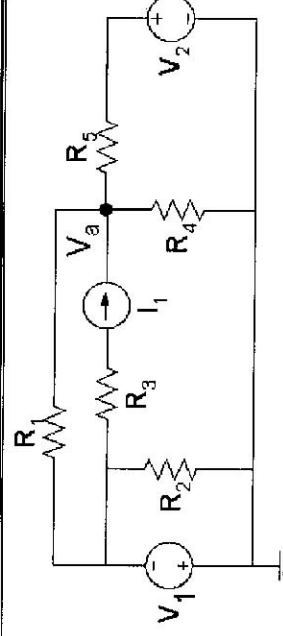

Nodal Analysis w/ "Floating Voltage Source"

A "floating" voltage source is one for which neither side is connected to the reference node, e.g. V_{LL} in the circuit below:

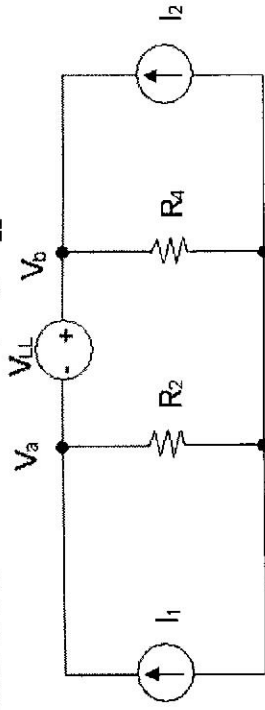

Problem: We cannot write KCL at nodes a or b because there is no way to express the current through the voltage source in terms of $V_a - V_b$.

Solution: Define a "supernode" – that chunk of the circuit containing nodes a and b. Express KCL for this supernode. Incorporate voltage source constraint into KCL equation.

Nodal Analysis: Example #3

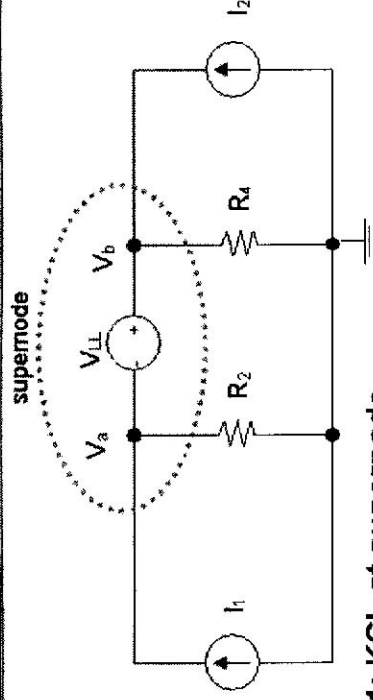

Eg'n 1: KCL at supernode

Substitute property of voltage source:

Node-Voltage Method and Dependent Sources

- If a circuit contains dependent sources, what to do?

Example:

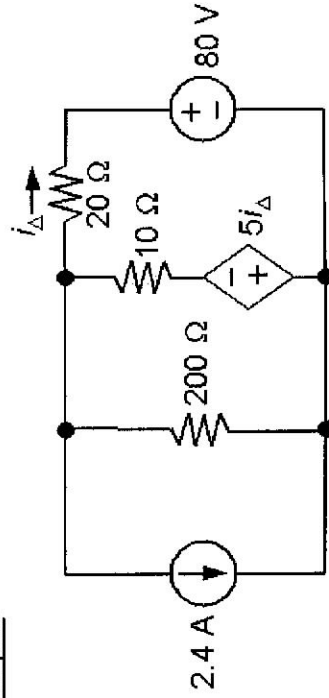

Node-Voltage Method and Dependent Sources

- Dependent current source: treat as independent current source in organizing and writing node eqns, but include (substitute) constraining dependency in terms of defined node voltages.
- Dependent voltage source: treat as independent voltage source in organizing and writing node eqns, but include (substitute) constraining dependency in terms of defined node voltages.

Example:

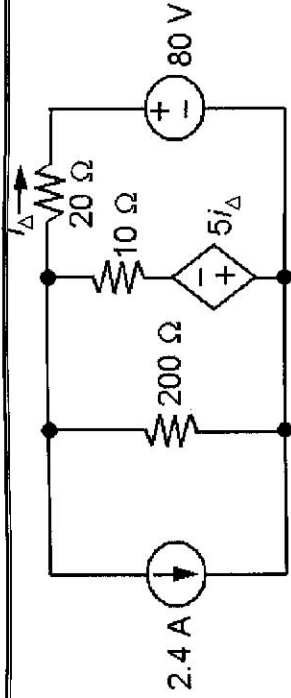

Formal Circuit Analysis Methods

NODAL ANALYSIS

("Node-Voltage Method")

- 0) Choose a reference node
- 1) Define unknown node voltages
=> N equations for N unknown node voltages
- 2) Apply KCL to each unknown node, expressing current in terms of the node voltages
=> N equations for N unknown node voltages
- 3) Solve for node voltages
=> determine branch currents

MESH ANALYSIS

("Mesh-Current Method")

- 1) Select M independent mesh currents such that at least one mesh current passes through each branch*
 $M = \# \text{branches} - \# \text{nodes} + 1$
- 2) Apply KVL to each mesh, expressing voltages in terms of mesh currents
=> M equations for M unknown mesh currents
- 3) Solve for mesh currents
=> determine node voltages

*Simple method for planar circuits

A mesh current is not necessarily identified with a branch current.

Mesh Analysis: Example #1

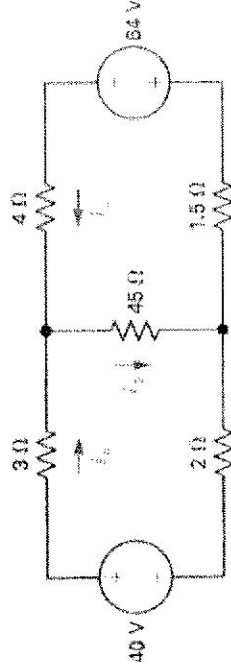

1. Select M mesh currents.
2. Apply KVL to each mesh.
3. Solve for mesh currents.

Mesh Analysis with a Current Source

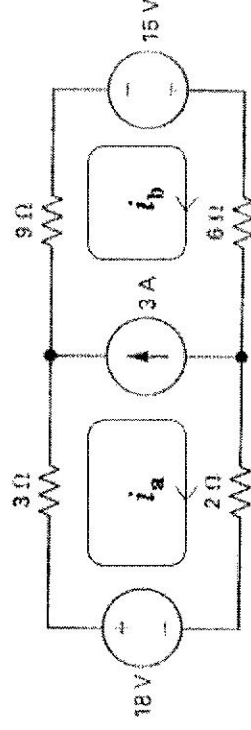

Problem: We cannot write KVL for meshes a and b because there is no way to express the voltage drop across the current source in terms of the mesh currents.

Solution: Define a "supermesh" – a mesh which avoids the branch containing the current source. Apply KVL for this supermesh.

Mesh Analysis: Example #2

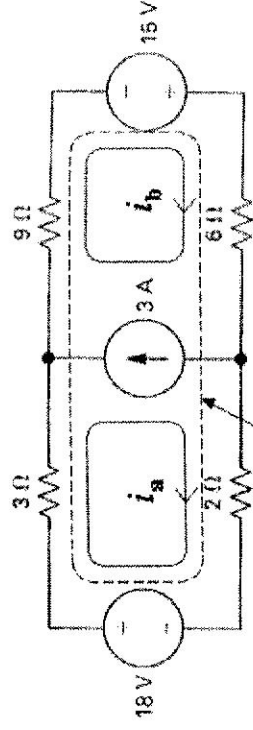

Eg'n 1: KVL for supermesh

Eg'n 2: Constraint due to current source:

Mesh Analysis with Dependent Sources

- Exactly analogous to Node Analysis
- Dependent Voltage Source: (1) Formulate and write KVL mesh eqns. (2) Include and express dependency constraint in terms of mesh currents
- Dependent Current Source: (1) Use supermesh. (2) Include and express dependency constraint in terms of mesh currents