

CS162 Operating Systems and Systems Programming Lecture 12

Protection (continued) Address Translation

October 9, 2006
Prof. John Kubiatowicz
<http://inst.eecs.berkeley.edu/~cs162>

Review: Important Aspects of Memory Multiplexing

- **Controlled overlap:**
 - Separate state of threads should not collide in physical memory. Obviously, unexpected overlap causes chaos!
 - Conversely, would like the ability to overlap when desired (for communication)
- **Translation:**
 - Ability to translate accesses from one address space (virtual) to a different one (physical)
 - When translation exists, processor uses virtual addresses, physical memory uses physical addresses
 - Side effects:
 - » Can be used to avoid overlap
 - » Can be used to give uniform view of memory to programs
- **Protection:**
 - Prevent access to private memory of other processes
 - » Different pages of memory can be given special behavior (Read Only, Invisible to user programs, etc).
 - » Kernel data protected from User programs
 - » Programs protected from themselves

10/9/06

Kubiatowicz CS162 ©UCB Fall 2006

Lec 12.2

Review: General Address Translation

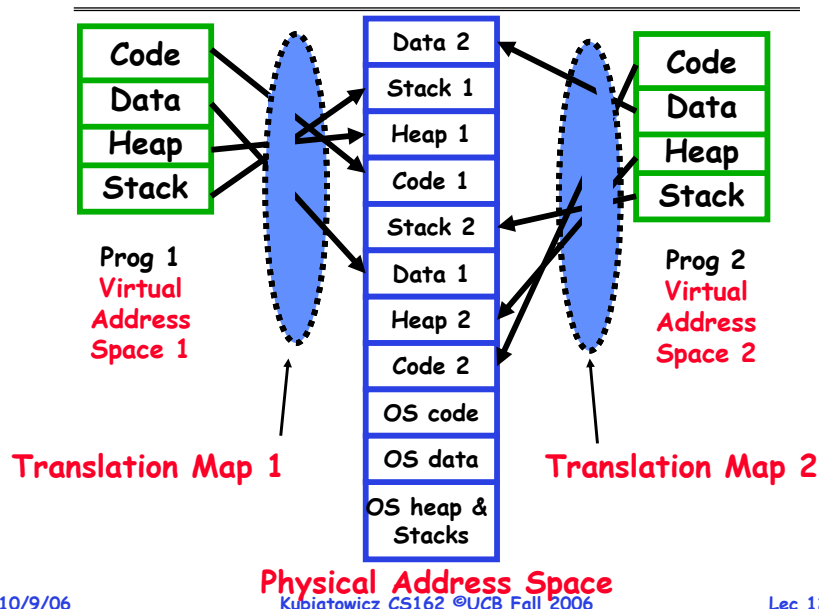

10/9/06

Physical Address Space
Kubiatowicz CS162 ©UCB Fall 2006

Lec 12.3

Review: User→Kernel (System Call)

- Can't let inmate (user) get out of padded cell on own
 - Would defeat purpose of protection!
 - So, how does the user program get back into kernel?

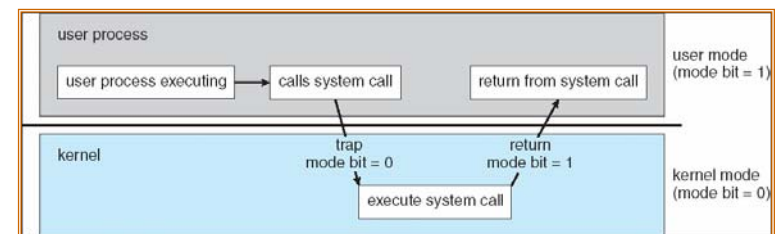

- **System call:** Voluntary procedure call into kernel
 - Hardware for controlled User→Kernel transition
 - Can any kernel routine be called?
 - » No! Only specific ones.
 - System call ID encoded into system call instruction
 - » Index forces well-defined interface with kernel

10/9/06

Kubiatowicz CS162 ©UCB Fall 2006

Lec 12.4

Goals for Today

- Finish discussion of protection
- Address Translation Schemes
 - Segmentation
 - Paging
 - Multi-level translation
 - Paged page tables
 - Inverted page tables
- Comparison among options

Note: Some slides and/or pictures in the following are adapted from slides ©2005 Silberschatz, Galvin, and Gagne. Many slides generated from my lecture notes by Kubiawicz.

10/9/06

Kubiawicz CS162 ©UCB Fall 2006

Lec 12.5

System Call Continued

- What are some system calls?
 - I/O: open, close, read, write, lseek
 - Files: delete, mkdir, rmdir, truncate, chown, chgrp, ..
 - Process: fork, exit, wait (like join)
 - Network: socket create, set options
- Are system calls constant across operating systems?
 - Not entirely, but there are lots of commonalities
 - Also some standardization attempts (POSIX)
- What happens at beginning of system call?
 - » On entry to kernel, sets system to kernel mode
 - » Handler address fetched from table/Handler started
- System Call argument passing:
 - In registers (not very much can be passed)
 - Write into user memory, kernel copies into kernel mem
 - » User addresses must be translated!w
 - » Kernel has different view of memory than user
 - Every Argument must be explicitly checked!

10/9/06

Kubiawicz CS162 ©UCB Fall 2006

Lec 12.6

User→Kernel (Exceptions: Traps and Interrupts)

- A system call instruction causes a synchronous exception (or "trap")
 - In fact, often called a software "trap" instruction
- Other sources of **Synchronous Exceptions**:
 - Divide by zero, Illegal instruction, Bus error (bad address, e.g. unaligned access)
 - Segmentation Fault (address out of range)
 - Page Fault (for illusion of infinite-sized memory)
- Interrupts are **Asynchronous Exceptions**
 - Examples: timer, disk ready, network, etc....
 - **Interrupts can be disabled, traps cannot!**
- On system call, exception, or interrupt:
 - Hardware enters kernel mode with interrupts disabled
 - Saves PC, then jumps to appropriate handler in kernel
 - For some processors (x86), processor also saves registers, changes stack, etc.
- Actual handler typically saves registers, other CPU state, and switches to kernel stack

10/9/06

Kubiawicz CS162 ©UCB Fall 2006

Lec 12.7

Additions to MIPS ISA to support Exceptions?

- Exception state is kept in "Coprocessor 0"
 - Use mfc0 read contents of these registers:
 - » **BadVAddr (register 8)**: contains memory address at which memory reference error occurred
 - » **Status (register 12)**: interrupt mask and enable bits
 - » **Cause (register 13)**: the cause of the exception
 - » **EPC (register 14)**: address of the affected instruction
- | | | | | | | | | |
|--------|------|---|-----|------|-----|---|---|---|
| | 15 | 8 | 5 | 4 | 3 | 2 | 1 | 0 |
| Status | Mask | | k | e | k | e | k | e |
| | | | old | prev | cur | | | |
- Status Register fields:
 - Mask: Interrupt enable
 - » 1 bit for each of 5 hardware and 3 software interrupts
 - k = kernel/user: 0⇒kernel mode
 - e = interrupt enable: 0⇒interrupts disabled
 - **Exception⇒6 LSB shifted left 2 bits, setting 2 LSB to 0:**
 - » run in kernel mode with interrupts disabled

10/9/06

Kubiawicz CS162 ©UCB Fall 2006

Lec 12.8

Communication



- Now that we have isolated processes, how can they communicate?
 - Shared memory: common mapping to physical page
 - » As long as place objects in shared memory address range, threads from each process can communicate
 - » Note that processes A and B can talk to shared memory through different addresses
 - » In some sense, this violates the whole notion of protection that we have been developing
 - If address spaces don't share memory, all inter-address space communication must go through kernel (via system calls)
 - » Byte stream producer/consumer (put/get): Example, communicate through pipes connecting stdin/stdout
 - » Message passing (send/receive): Will explain later how you can use this to build remote procedure call (RPC) abstraction so that you can have one program make procedure calls to another
 - » File System (read/write): File system is shared state!

10/9/06

Kubiatowicz CS162 ©UCB Fall 2006

Lec 12.9

Administrivia

- Midterm I coming up in two days:
 - Wednesday, 10/11, 4:00pm-7:00pm, Here (10 Evans)
 - Should be 2 hour exam with extra time
 - Closed book, one page of hand-written notes (both sides)
- Makeup Exam?
 - Email me today! I thought there was one student, but...
- No class on day of Midterm
 - Extra Office Hours: Tue 11-12, W 11-12
- Midterm Topics
 - Topics: Everything up to today (Monday 10/9)
 - History, Concurrency, Multithreading, Synchronization, Protection/Address Spaces
- Make sure to fill out Group Evaluations!
- Project 2
 - Initial Design Document due Tuesday 10/17
 - Make sure to look at the lecture schedule to keep up with the project due dates!

10/9/06

Kubiatowicz CS162 ©UCB Fall 2006

Lec 12.10

Simple Segmentation: Base and Bounds (CRAY-1)

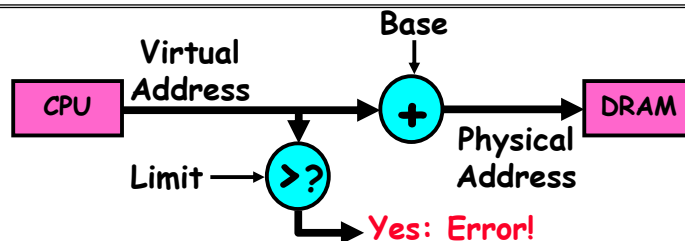

- Can use base & bounds/limit for dynamic address translation (Simple form of "segmentation"):
 - Alter every address by adding "base"
 - Generate error if address bigger than limit
- This gives program the illusion that it is running on its own dedicated machine, with memory starting at 0
 - Program gets continuous region of memory
 - Addresses within program do not have to be relocated when program placed in different region of DRAM

10/9/06

Kubiatowicz CS162 ©UCB Fall 2006

Lec 12.11

Base and Limit segmentation discussion

- Provides level of indirection
 - OS can move bits around behind program's back
 - Can be used to correct if program needs to grow beyond its bounds or coalesce fragments of memory
- Only OS gets to change the base and limit!
 - Would defeat protection
- What gets saved/restored on a context switch?
 - Everything from before + base/limit values
 - Or: How about complete contents of memory (out to disk)?
 - » Called "Swapping"
- Hardware cost
 - 2 registers/Adder/Comparator
 - Slows down hardware because need to take time to do add/compare on every access
- Base and Limit Pros: Simple, relatively fast

10/9/06

Kubiatowicz CS162 ©UCB Fall 2006

Lec 12.12

Cons for Simple Segmentation Method

- Fragmentation problem (complex memory allocation)
 - Not every process is the same size
 - Over time, memory space becomes fragmented
 - Really bad if want space to grow dynamically (e.g. heap)

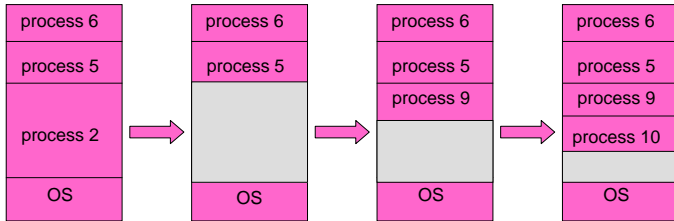

- Other problems for process maintenance
 - Doesn't allow heap and stack to grow independently
 - Want to put these as far apart in virtual memory space as possible so that they can grow as needed
- Hard to do inter-process sharing
 - Want to share code segments when possible
 - Want to share memory between processes

10/9/06

Kubiatowicz CS162 ©UCB Fall 2006

Lec 12.13

More Flexible Segmentation

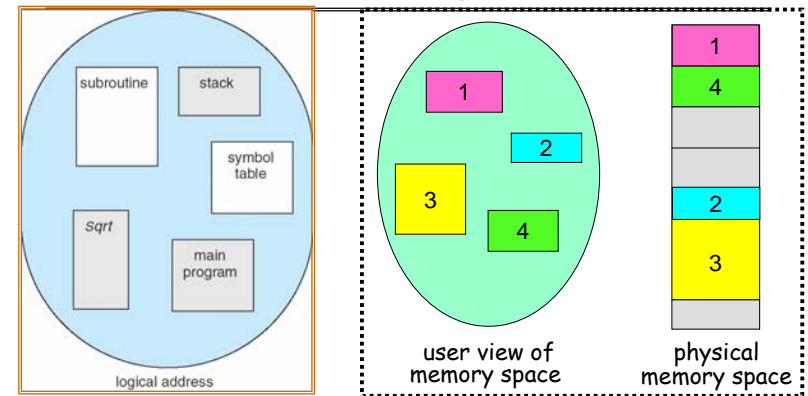

- Logical View: multiple separate segments
 - Typical: Code, Data, Stack
 - Others: memory sharing, etc
- Each segment is given region of contiguous memory
 - Has a base and limit
 - Can reside anywhere in physical memory

10/9/06

Kubiatowicz CS162 ©UCB Fall 2006

Lec 12.14

Intel x86 Special Registers



80386 Special Registers

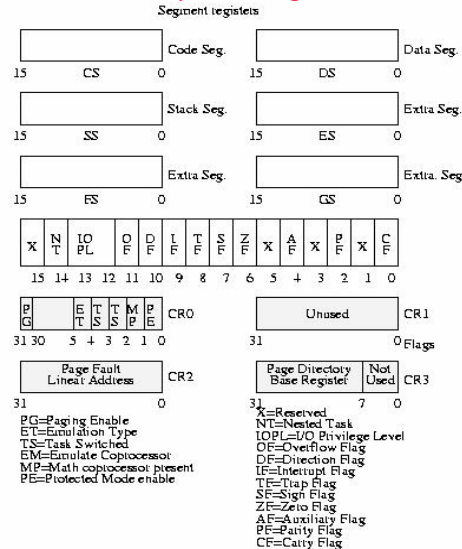

RPL = Requestor Privilege Level
 TL = Table Indicator
 (0 = GDT, 1 = LDT)
 Index = Index into table

Protected Mode segment selector

Typical Segment Register
 Current Priority is RPL
 Of Code Segment (CS)

10/9/06

Kubiatowicz CS162 ©UCB Fall 2006

Lec 12.15

Implementation of Multi-Segment Model

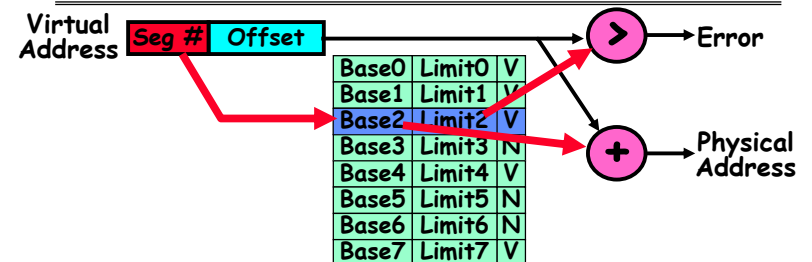

- Segment map resides in processor
 - Segment number mapped into base/limit pair
 - Base added to offset to generate physical address
 - Error check catches offset out of range
- As many chunks of physical memory as entries
 - Segment addressed by portion of virtual address
 - However, could be included in instruction instead:
 - x86 Example: `mov [es:bx], ax.`
- What is "V/N"?
 - Can mark segments as invalid; requires check as well

10/9/06

Kubiatowicz CS162 ©UCB Fall 2006

Lec 12.16

Example: Four Segments (16 bit addresses)



Seg ID #	Base	Limit
0 (code)	0x4000	0x0800
1 (data)	0x4800	0x1400
2 (shared)	0xF000	0x1000
3 (stack)	0x0000	0x3000

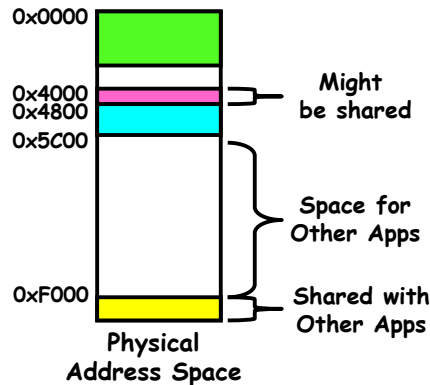
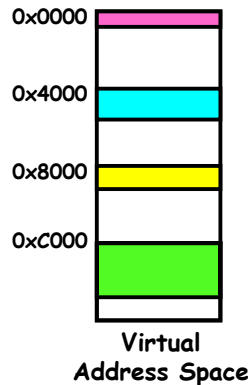

10/9/06

Kubiatowicz CS162 ©UCB Fall 2006

Lec 12.17

Example of segment translation

```

0x240 main: la $a0, varx
0x244          jal strlen
...
0x360 strlen: li $v0, 0 ;count
0x364 loop:  lb $t0, ($a0)
0x368          beq $r0,$t1, done
...
0x4050 varx   dw  0x314159
    
```

Seg ID #	Base	Limit
0 (code)	0x4000	0x0800
1 (data)	0x4800	0x1400
2 (shared)	0xF000	0x1000
3 (stack)	0x0000	0x3000

Let's simulate a bit of this code to see what happens (PC=0x240):

- Fetch 0x240. Virtual segment #? 0; Offset? 0x240
Physical address? Base=0x4000, so physical addr=0x4240
Fetch instruction at 0x4240. Get "la \$a0, varx"
Move 0x4050 → \$a0, Move PC+4→PC
- Fetch 0x244. Translated to Physical=0x4244. Get "jal strlen"
Move 0x0248 → \$ra (return address!), Move 0x0360 → PC
- Fetch 0x360. Translated to Physical=0x4360. Get "li \$v0, 0"
Move 0x0000 → \$v0, Move PC+4→PC
- Fetch 0x364. Translated to Physical=0x4364. Get "lb \$t0,(\$a0)"
Since \$a0 is 0x4050, try to load byte from 0x4050
Translate 0x4050. Virtual segment #? 1; Offset? 0x50
Physical address? Base=0x4800, Physical addr = 0x4850,
Load Byte from 0x4850→\$t0, Move PC+4→PC

10/9/06

Kubiatowicz CS162 ©UCB Fall 2006

Lec 12.18

Observations about Segmentation

- Virtual address space has holes
 - Segmentation efficient for sparse address spaces
 - A correct program should never address gaps (except as mentioned in moment)
 - » If it does, trap to kernel and dump core
- When it is OK to address outside valid range:
 - This is how the stack and heap are allowed to grow
 - For instance, stack takes fault, system automatically increases size of stack
- Need protection mode in segment table
 - For example, code segment would be read-only
 - Data and stack would be read-write (stores allowed)
 - Shared segment could be read-only or read-write
- What must be saved/restored on context switch?
 - Segment table stored in CPU, not in memory (small)
 - Might store all of processes memory onto disk when switched (called "swapping")

10/9/06

Kubiatowicz CS162 ©UCB Fall 2006

Lec 12.19

Schematic View of Swapping

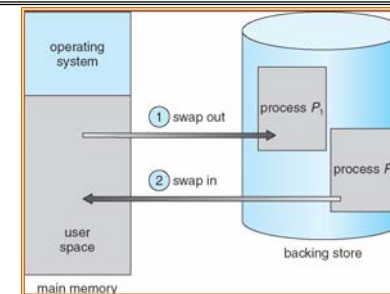

- Extreme form of Context Switch: Swapping
 - In order to make room for next process, some or all of the previous process is moved to disk
 - » Likely need to send out complete segments
 - This greatly increases the cost of context-switching
- Desirable alternative?
 - Some way to keep only active portions of a process in memory at any one time
 - Need finer granularity control over physical memory

10/9/06

Kubiatowicz CS162 ©UCB Fall 2006

Lec 12.20

Paging: Physical Memory in Fixed Size Chunks

- **Problems with segmentation?**
 - Must fit variable-sized chunks into physical memory
 - May move processes multiple times to fit everything
 - Limited options for swapping to disk
- **Fragmentation:** wasted space
 - **External:** free gaps between allocated chunks
 - **Internal:** don't need all memory within allocated chunks
- **Solution to fragmentation from segments?**
 - Allocate physical memory in fixed size chunks ("pages")
 - Every chunk of physical memory is equivalent
 - » Can use simple vector of bits to handle allocation: 00110001110001101 ... 110010
 - » Each bit represents page of physical memory
1⇒allocated, 0⇒free
- **Should pages be as big as our previous segments?**
 - No: Can lead to lots of internal fragmentation
 - » Typically have small pages (1K-16K)
 - **Consequently:** need multiple pages/segment

10/9/06

Kubiatowicz CS162 ©UCB Fall 2006

Lec 12.21

How to Implement Paging?

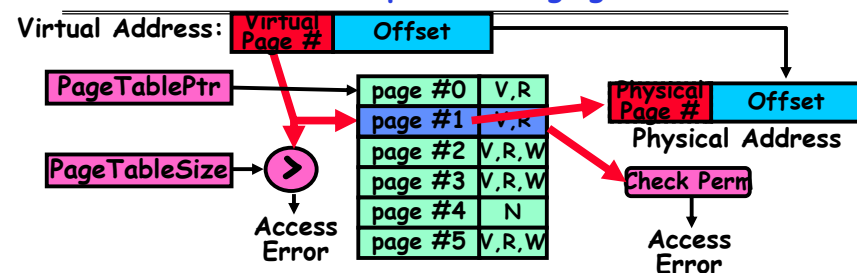

- **Page Table (One per process)**
 - Resides in physical memory
 - Contains physical page and permission for each virtual page
 - » Permissions include: Valid bits, Read, Write, etc
- **Virtual address mapping**
 - Offset from Virtual address copied to Physical Address
 - » Example: 10 bit offset ⇒ 1024-byte pages
 - Virtual page # is all remaining bits
 - » Example for 32-bits: 32-10 = 22 bits, i.e. 4 million entries
 - » Physical page # copied from table into physical address
 - **Check Page Table bounds and permissions**

10/9/06

Kubiatowicz CS162 ©UCB Fall 2006

Lec 12.22

What about Sharing?

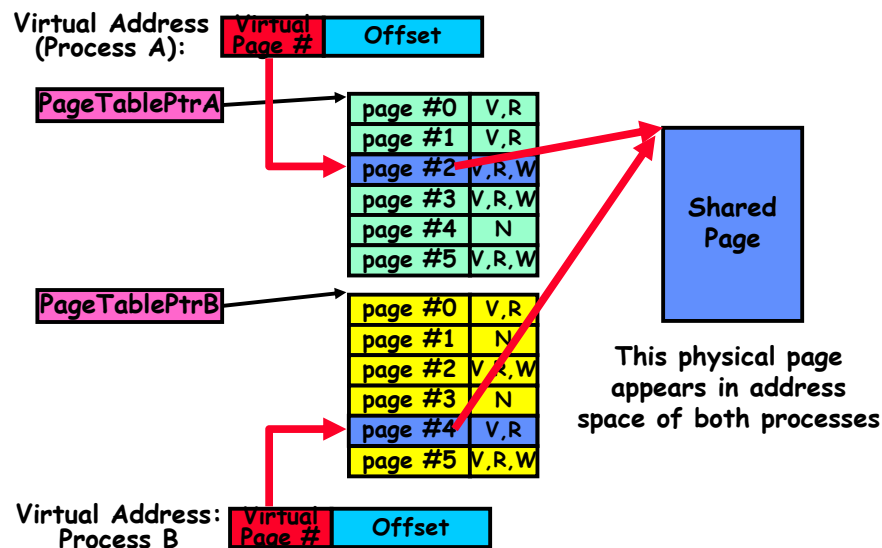

10/9/06

Kubiatowicz CS162 ©UCB Fall 2006

Lec 12.23

Simple Page Table Discussion

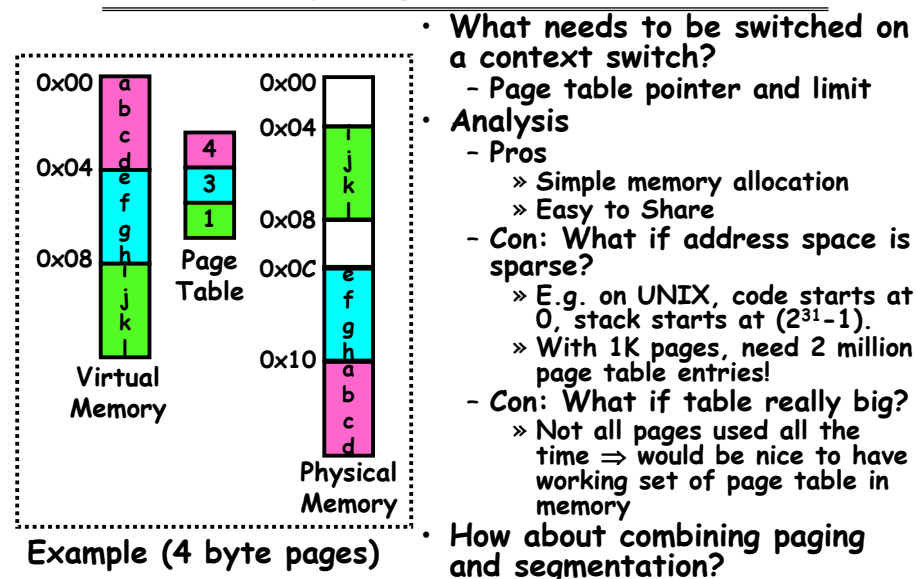

Example (4 byte pages)

- **What needs to be switched on a context switch?**
 - Page table pointer and limit
- **Analysis**
 - Pros
 - » Simple memory allocation
 - » Easy to Share
 - Con: What if address space is sparse?
 - » E.g. on UNIX, code starts at 0, stack starts at $(2^{31}-1)$.
 - » With 1K pages, need 2 million page table entries!
 - Con: What if table really big?
 - » Not all pages used all the time ⇒ would be nice to have working set of page table in memory
- **How about combining paging and segmentation?**

10/9/06

Kubiatowicz CS162 ©UCB Fall 2006

Lec 12.24

Multi-level Translation

- What about a tree of tables?
 - Lowest level page table \Rightarrow memory still allocated with bitmap
 - Higher levels often segmented
- Could have any number of levels. Example (top segment):

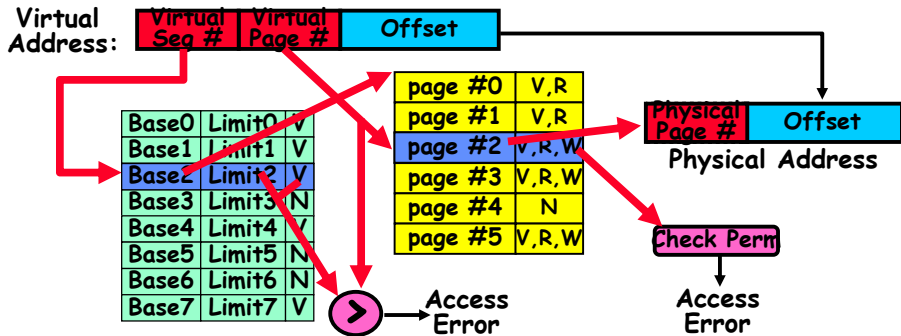

- What must be saved/restored on context switch?
 - Contents of top-level segment registers (for this example)
 - Pointer to top-level table (page table)

10/9/06

Kubiatowicz CS162 ©UCB Fall 2006

Lec 12.25

What about Sharing (Complete Segment)?

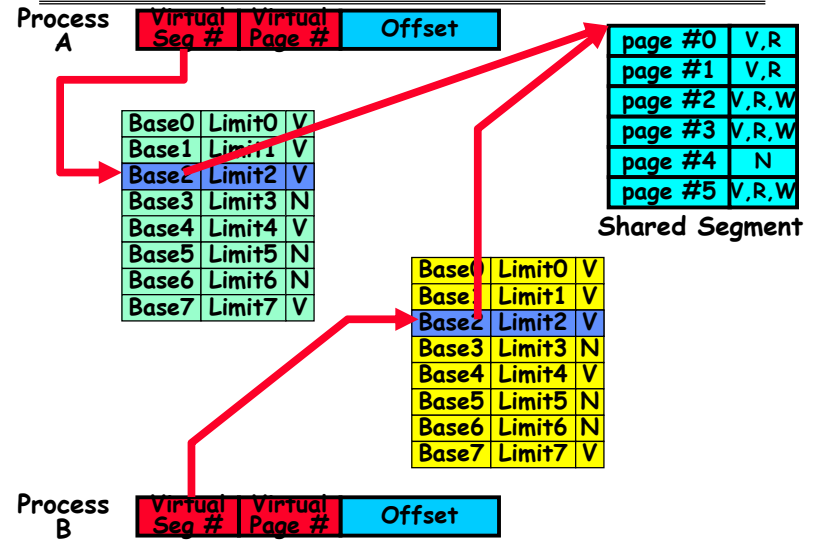

10/9/06

Kubiatowicz CS162 ©UCB Fall 2006

Lec 12.26

Another common example: two-level page table

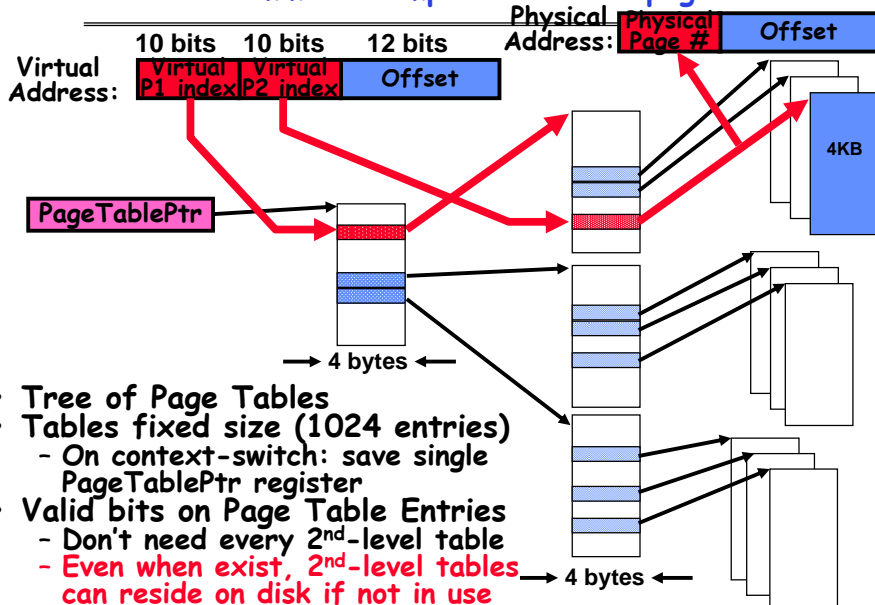

- Tree of Page Tables
- Tables fixed size (1024 entries)
 - On context-switch: save single PageTablePtr register
- Valid bits on Page Table Entries
 - Don't need every 2nd-level table
 - Even when exist, 2nd-level tables can reside on disk if not in use

10/9/06

Kubiatowicz CS162 ©UCB Fall 2006

Lec 12.27

Multi-level Translation Analysis

- Pros:
 - Only need to allocate as many page table entries as we need for application
 - » In other words, sparse address spaces are easy
 - Easy memory allocation
 - Easy Sharing
 - » Share at segment or page level (need additional reference counting)
- Cons:
 - One pointer per page (typically 4K - 16K pages today)
 - Page tables need to be contiguous
 - » However, previous example keeps tables to exactly one page in size
 - Two (or more, if >2 levels) lookups per reference
 - » Seems very expensive!

10/9/06

Kubiatowicz CS162 ©UCB Fall 2006

Lec 12.28

Inverted Page Table

- With all previous examples ("Forward Page Tables")
 - Size of page table is at least as large as amount of virtual memory allocated to processes
 - Physical memory may be much less
 - » Much of process space may be out on disk or not in use

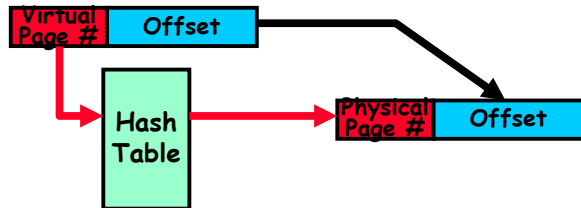

- Answer: use a hash table
 - Called an "Inverted Page Table"
 - Size is independent of virtual address space
 - Directly related to amount of physical memory
 - Very attractive option for 64-bit address spaces
- Cons: Complexity of managing hash changes
 - Often in hardware!

10/9/06

Kubiatowicz CS162 ©UCB Fall 2006

Lec 12.29

Closing thought: Protection without Hardware

- Does protection require hardware support for translation and dual-mode behavior?
 - No: Normally use hardware, but anything you can do in hardware can also do in software (possibly expensive)
- Protection via Strong Typing
 - Restrict programming language so that you can't express program that would trash another program
 - Loader needs to make sure that program produced by valid compiler or all bets are off
 - Example languages: LISP, Ada, Modula-3 and Java
- Protection via software fault isolation:
 - Language independent approach: have compiler generate object code that provably can't step out of bounds
 - » Compiler puts in checks for every "dangerous" operation (loads, stores, etc). Again, need special loader.
 - » Alternative, compiler generates "proof" that code cannot do certain things (Proof Carrying Code)
 - Or: use virtual machine to guarantee safe behavior (loads and stores recompiled on fly to check bounds)

10/9/06

Kubiatowicz CS162 ©UCB Fall 2006

Lec 12.30

Summary (1/2)

- Memory is a resource that must be shared
 - Controlled Overlap: only shared when appropriate
 - Translation: Change Virtual Addresses into Physical Addresses
 - Protection: Prevent unauthorized Sharing of resources
- Dual-Mode
 - Kernel/User distinction: User restricted
 - User→Kernel: System calls, Traps, or Interrupts
 - Inter-process communication: shared memory, or through kernel (system calls)
- Exceptions
 - Synchronous Exceptions: Traps (including system calls)
 - Asynchronous Exceptions: Interrupts

10/9/06

Kubiatowicz CS162 ©UCB Fall 2006

Lec 12.31

Summary (2/2)

- Segment Mapping
 - Segment registers within processor
 - Segment ID associated with each access
 - » Often comes from portion of virtual address
 - » Can come from bits in instruction instead (x86)
 - Each segment contains base and limit information
 - » Offset (rest of address) adjusted by adding base
- Page Tables
 - Memory divided into fixed-sized chunks of memory
 - Virtual page number from virtual address mapped through page table to physical page number
 - Offset of virtual address same as physical address
 - Large page tables can be placed into virtual memory
- Multi-Level Tables
 - Virtual address mapped to series of tables
 - Permit sparse population of address space
- Inverted page table
 - Size of page table related to physical memory size

10/9/06

Kubiatowicz CS162 ©UCB Fall 2006

Lec 12.32