

HSPICE

Solution for Linear Network

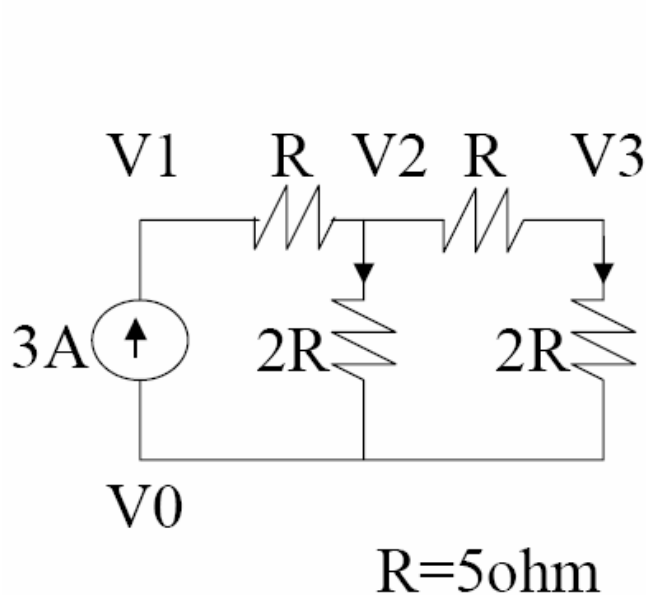

$$\begin{pmatrix} 0.2 & 0 & -0.1 & -0.1 \\ 0 & 0.2 & -0.2 & 0 \\ -0.1 & -0.2 & 0.5 & -0.2 \\ 0 & 0 & -0.2 & 0.2 \end{pmatrix} \begin{pmatrix} V_0 \\ V_1 \\ V_2 \\ V_3 \end{pmatrix} = \begin{pmatrix} -3 \\ 3 \\ 0 \\ 0 \end{pmatrix}$$

$$\begin{pmatrix} 0.2 & -0.2 & 0 \\ -0.2 & 0.5 & -0.2 \\ 0 & -0.2 & 0.2 \end{pmatrix} \begin{pmatrix} V_1 \\ V_2 \\ V_3 \end{pmatrix} = \begin{pmatrix} 3 \\ 0 \\ 0 \end{pmatrix} \quad V_0 \text{ ground}$$

With Gaussian elimination

$$\begin{pmatrix} 0.2 & -0.2 & 0 \\ 0 & 0.3 & -0.2 \\ 0 & 0 & 0.25 \end{pmatrix} \begin{pmatrix} V_1 \\ V_2 \\ V_3 \end{pmatrix} = \begin{pmatrix} 3 \\ 3 \\ 3 \end{pmatrix}$$

Iteration for Nonlinear Network

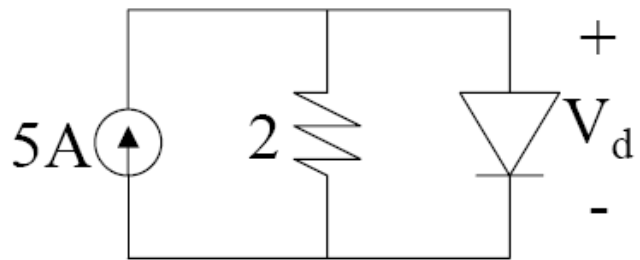

$$I_d = 1\text{pA} * [\exp(40 * V_d) - 1]$$

$$5 = V_d / 2 + I_d$$

$$5 = V_d / 2 + 1\text{pA} * [\exp(40 * V_d) - 1]$$

$$V_{d+1} = V_d - F(V_d) / F'(V_d)$$

	V_d	V_{d+1}	Delta V
1	1	0.975001	0.02499
2	0.975001	0.950002	0.02499
3	0.950002	0.925005	0.02499
4	0.925005	0.900015	0.02499
5	0.900015	0.875041	0.02497
6	0.875041	0.850113	0.02493
7	0.850117	0.825309	0.02481
8	0.825309	0.800838	0.02447
9	0.800838	0.777250	0.02359
10	0.777250	0.755885	0.02136
11	0.755885	0.739445	0.01644
12	0.739447	0.730983	0.00846
13	0.730983	0.729186	0.00179
14	0.729186	0.729119	0.00007

HSPICE Data Flow

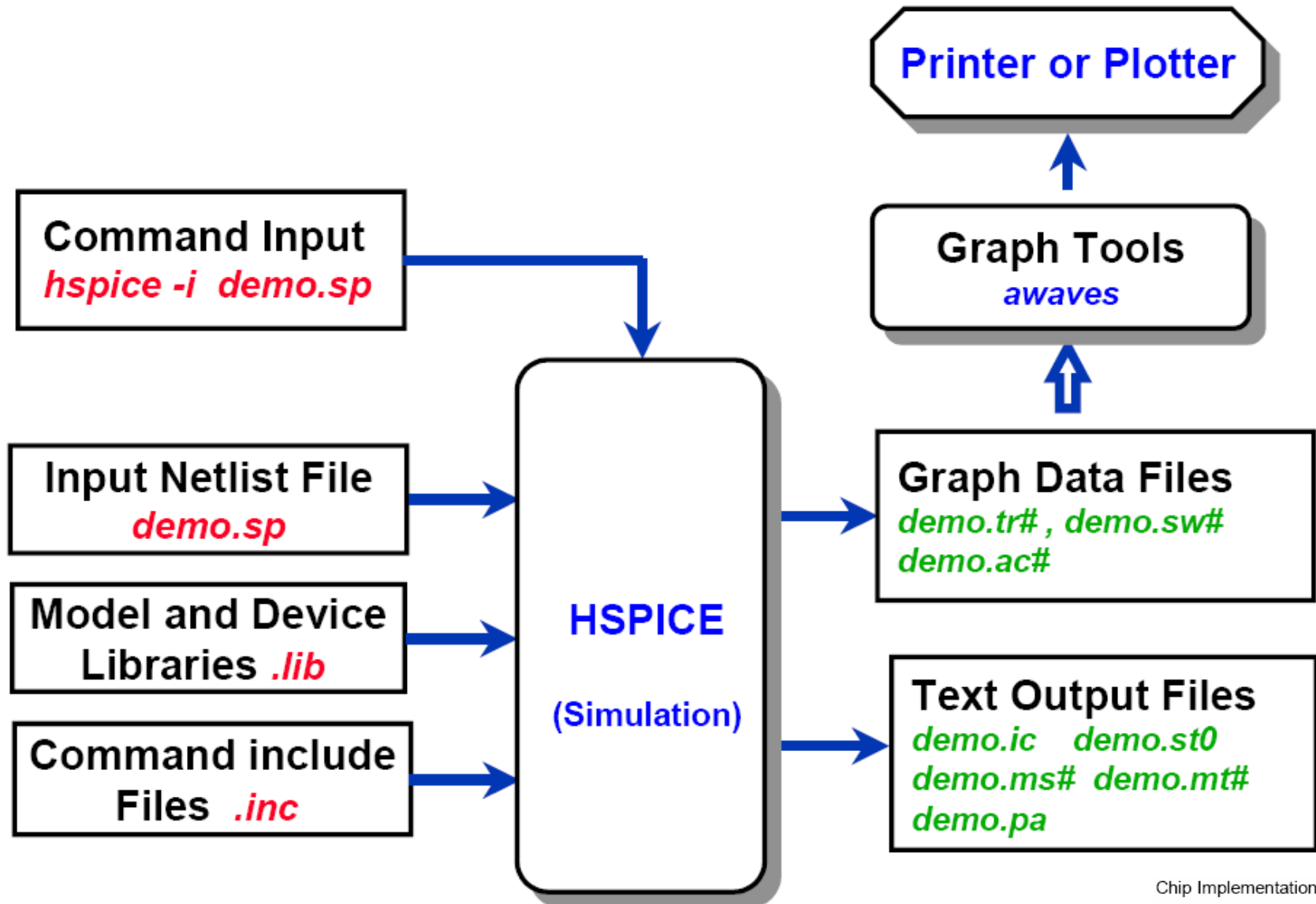

Netlist Structure

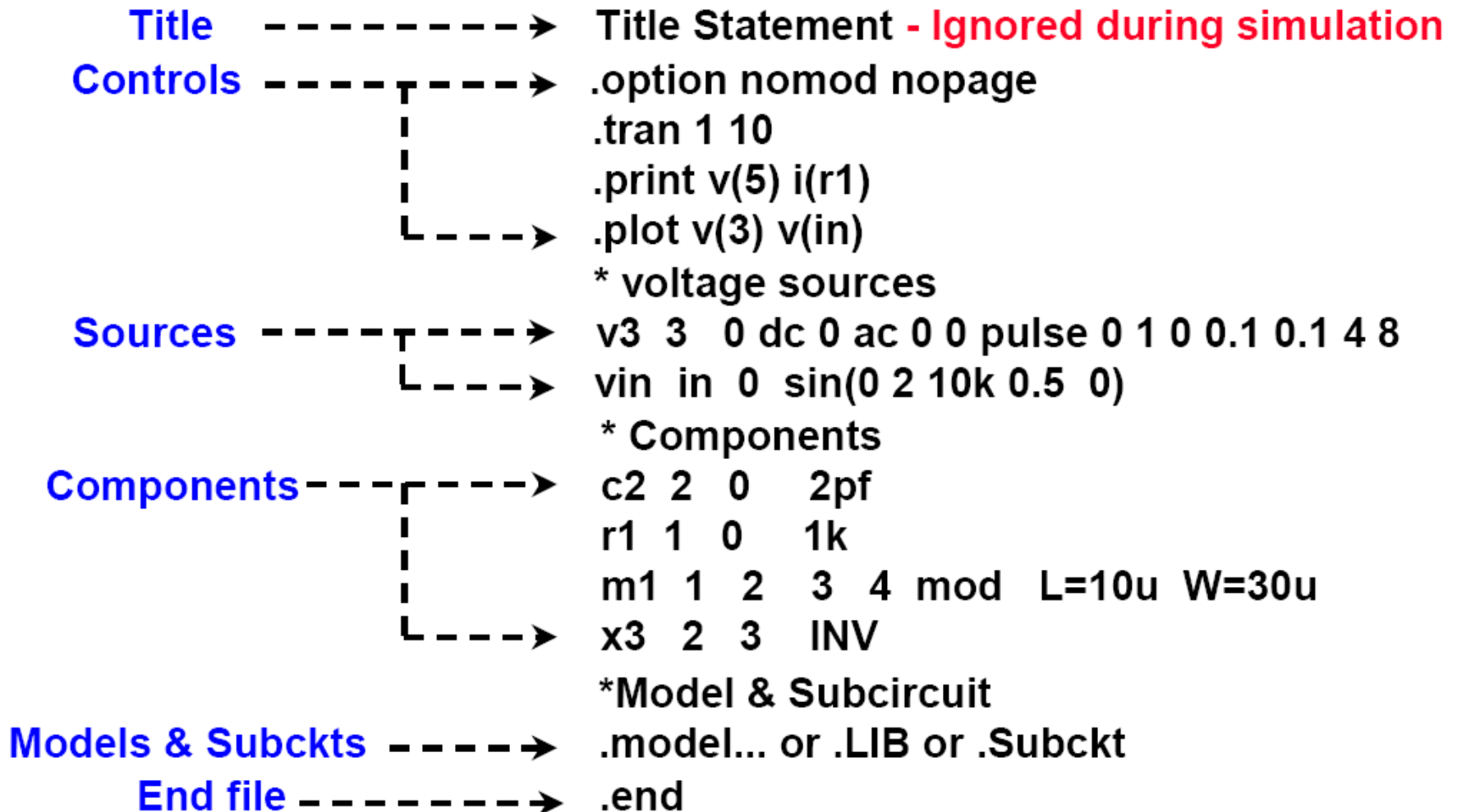

Element Names

C	Capacitor
D	Diode
E,F,G,H	Dependent Current and Voltage Controlled Sources
I	Current
J	JFET or MESFET
K	Mutual Inductor
L	Inductor
M	MOSFET
Q	BJT
R	Resistor
O,T,U	Transmission Line
V	Voltage Source
X	Subcircuit Call

Units and Scale Factors

● Units:

R Ohm (e.g. R1 n1 n2 1K)
C Farad (e.g. C2 n3 n4 1e-12)
L Henry (e.g. L3 n5 n6 1e-9)

● Scale Factors :

F	1e-15
P	1e-12
N	1e-9
U	1e-6
M	1e-3

K	1e3
Meg	1e6
G	1e9
T	1e12
DB	$20\log_{10}$

Examples:

1pF
1nH
10Meg Hz
vdb(v3)

● Technology Scaling : All Length and Widths are in **Meters**

Using `.options scale=1e-6` → **L=2 W=100**

Node Naming Conventions

- Either Names or Numbers (e.g. data1, n3, 11,)
- **0 (zero)** is Always Ground
- Trailing Alphabetic Character are ignored in Node Number, (e.g. **5A=5B=5**)
- All nodes are assumed to be local
- Node Names can be may Across all Subcircuits by a **.GLOBAL** Statement (e.g. **.GLOBAL VDD VSS**)

.SUBCKT Statement

```
.SUBCKT subname n1 <n2 n3...> <param=val...>  
.ENDS [subname]
```

Example:

```
.SUBCKT INV IN OUT WN=2u WP=8u  
M1 OUT IN VDD VDD P L=0.5u W=WP  
M2 OUT IN 0 0 N L=0.5u W=WN  
R1 OUT 4 1K  
R2 4 5 10K  
.ENDS INV  
*  
X1 1 2 INV WN=5u WP=20u  
X2 2 3 INV WN=10u WP=40u
```

Sources

Transient Sources - PULSE

■ Syntax :

```
PULSE ( V1 V2 < Tdelay Trise Tfall Pwidth Period > )
```

■ Example :

```
Vin 1 0 PULSE ( 0V 5V 10ns 10ns 10ns 40ns 100ns )
```

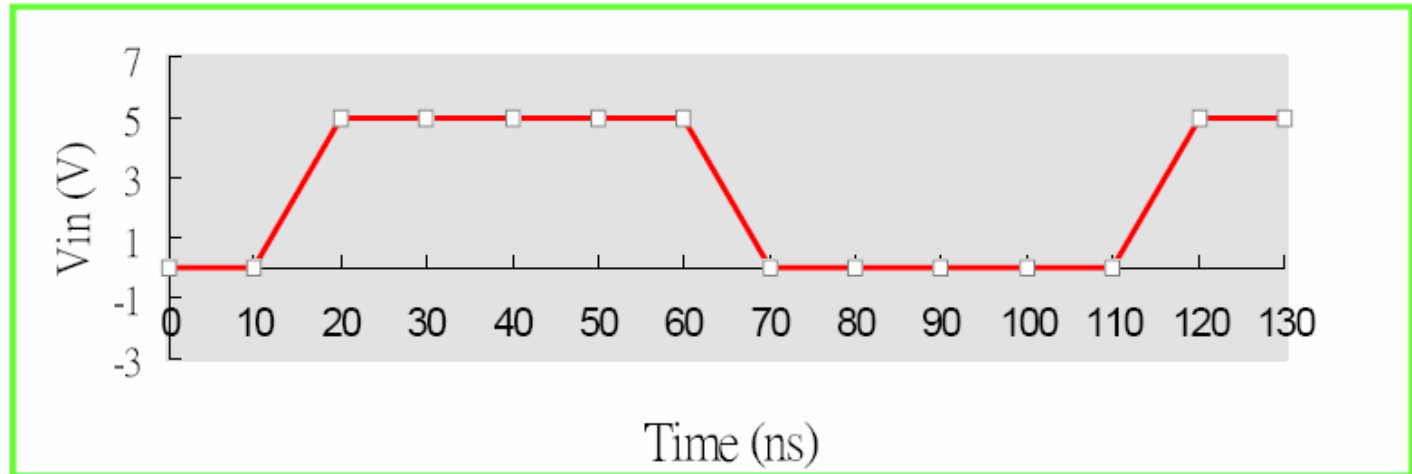

Transient Sources - SIN

■ Syntax :

```
SIN ( Voffset Vacmag < Freq Tdelay Dfactor > )
```

Voffset + Vacmag * e^{-(t-TD)} * Dfactor * sin(2π Freq(t-TD))

■ Example :

```
Vin 3 0 SIN ( 0V 1V 100Meg 2ns 5e7 )
```

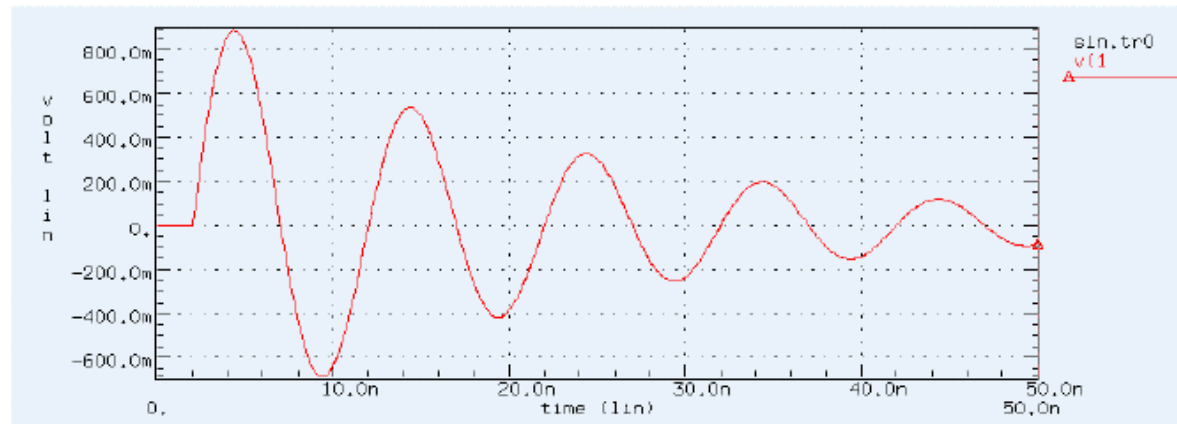

Transient Sources - PWL

■ Syntax :

```
PWL ( <t1 v1 t2 v2 .....> <R<=repeat>> <Tdelay=delay> )
```

```
$ R=repeat_from_what_time TD=time_delay_before_PWL_start
```

■ Example :

```
V1 1 0 PWL 60n 0v, 120n 0v, 130n 5v, 170n 5v, 180n 0v, R 0
```

```
V2 2 0 PL 0v 60n, 0v 120n, 5v 130n, 5v 170n, 0v 180n, R 60n
```

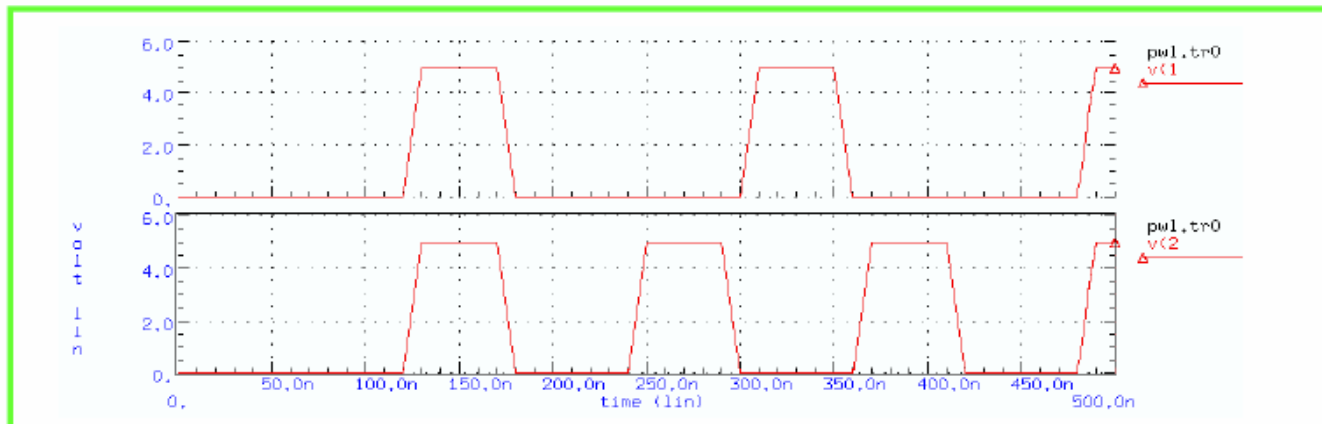

AC and DC Sources

Example of DC Sources

V1 1 0 DC=5V

V2 2 0 5V

I3 3 0 5mA

Example of AC Sources

V4 4 0 AC=10V, 90

V5 5 0 AC 1.0 180

Example of Mixed Sources

V6 6 0 5V AC=1V, 90

V7 7 0 0.5V AC 1.0 SIN (0 1 1Meg)

Dependent Sources

Voltage Controlled Voltage Sources (VCVS) --- E Elements

Voltage Controlled Current Sources (VCCS) --- G Elements

Current Controlled Voltage Sources (CCVS) --- H Elements

Current Controlled Current Sources (CCCS) --- F Elements

<i>E(name)</i>	<i>N+</i>	<i>N-</i>	<i>NC+</i>	<i>NC-</i>	<i>(Voltage Gain Value)</i>
-----------------------	------------------	------------------	-------------------	-------------------	------------------------------------

<i>Eopamp</i>	3	4	1	2	1e6
----------------------	----------	----------	----------	----------	------------

<i>Ebuf</i>	2	0	1	0	1.0
--------------------	----------	----------	----------	----------	------------

Analysis Type

Analysis Type

- DC Operating Point : *First Calculated for ALL Analysis Types*

.OP .IC .NODESET

- DC Sweep & DC Small Signal Analysis :

.DC .TF .PZ .SENS

- AC Sweep & Small Signal Analysis :

.AC .NOISE .DISTO .SAMPLE .NET

- Transient Analysis:

.TRAN .FOUR (UIC)

DC Sweep

```
.DC var1 start1 stop1 incr1 < var2 start2 stop2 incr2 > )
```

```
.DC var1 start1 stop1 incr1 < SWEEP var2 DEC/OCT/LIN/POI np start2 stop2 > )
```

Example:

```
.DC VIN 0.25 5.0 0.25
```

```
.DC VDS 0 10 0.5 VGS 0 5 1
```

```
.DC TEMP -55 125 10
```

```
.DC TEMP POI 5 0 30 50 100 125
```

```
.DC xval 1k 10k 0.5k SWEEP TEMP LIN 5 25 125
```

Transient and AC Analysis

.TRAN tincr1 tstop1

.TRAN 1NS 100NS

.AC DEC/OCT/LIN/POI np fstart fstop

.AC DEC 10 1K 100MEG

Element Models

R1 12 17 1K TC1=1.3e-3 TC2=-3.1e-7

C2 7 8 0.6pf IC=5V

LSHUNT 23 51 10UH 0.01 1 IC=15.7mA

K4 Laa Lbb 0.9999

Graphic Tool - AWAVES

AWAVES Window

menu

Tool button

waveform

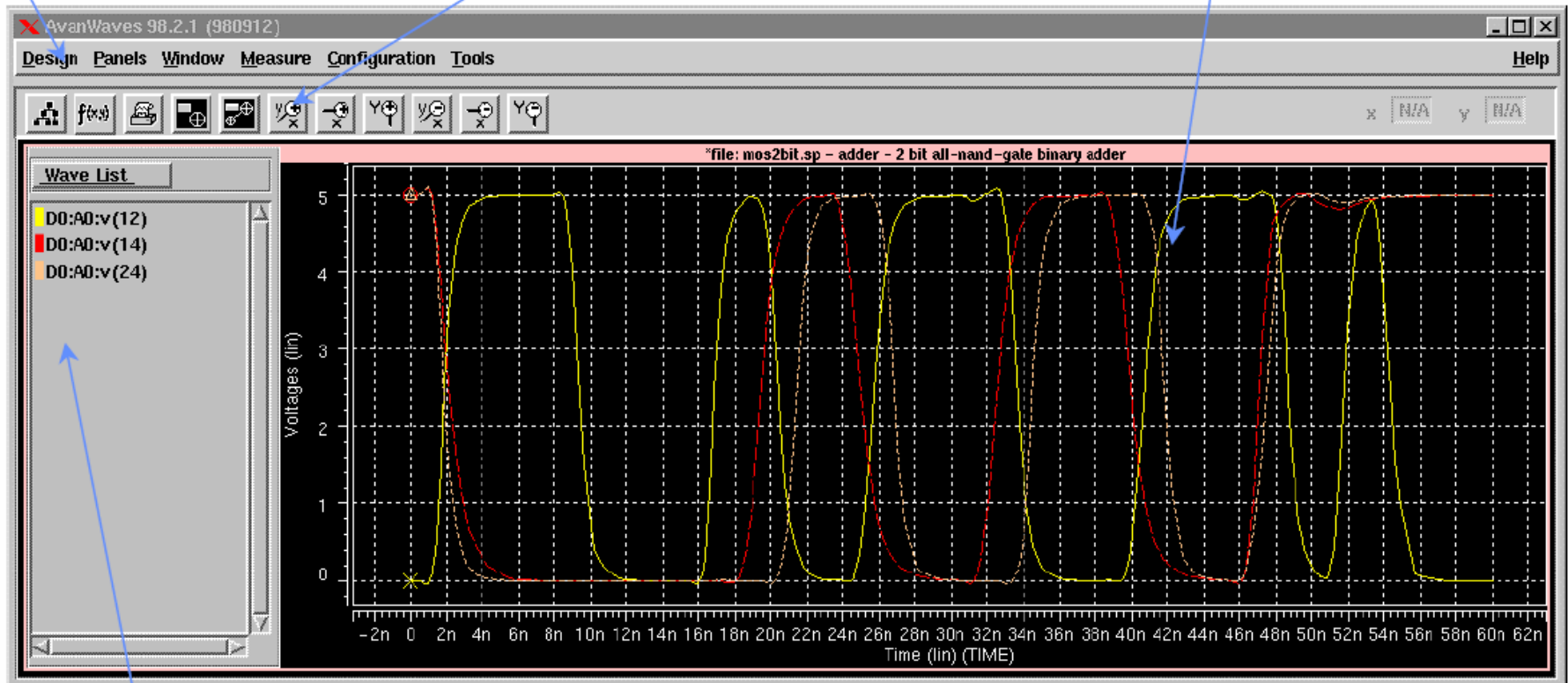

Data names

Result Browser

The screenshot shows the Results Browser window with the following annotations:

- Design name:** Points to the "Design:" field containing "D0: /users2/cic/wjhsu/HSPICE/tests/m2bit".
- Analysis type in design:** Points to the "A0" analysis type and the description "Transient: *file: mos2bit.sp - adder - 2 bit all-nand-gate binary ad".
- Instance name and hierarchy:** Points to the "Hierarchy:" list containing "IO1", "x2", and "x1".
- Data to be shown:** Points to the "Curves:" list containing "v(4)", "v(12)", "v(14)", and "v(22)".
- Data type:** Points to the "Types:" list containing "Time", "Voltages", "TPOWRD", and "Measures".
- Set X axis:** Points to the "Current X-Axis" field containing "TIME".

The window also includes a "Filter" field with an asterisk (*) and buttons for "Apply", "Default", "Close", and "Help".

Measurement

On window measurement function

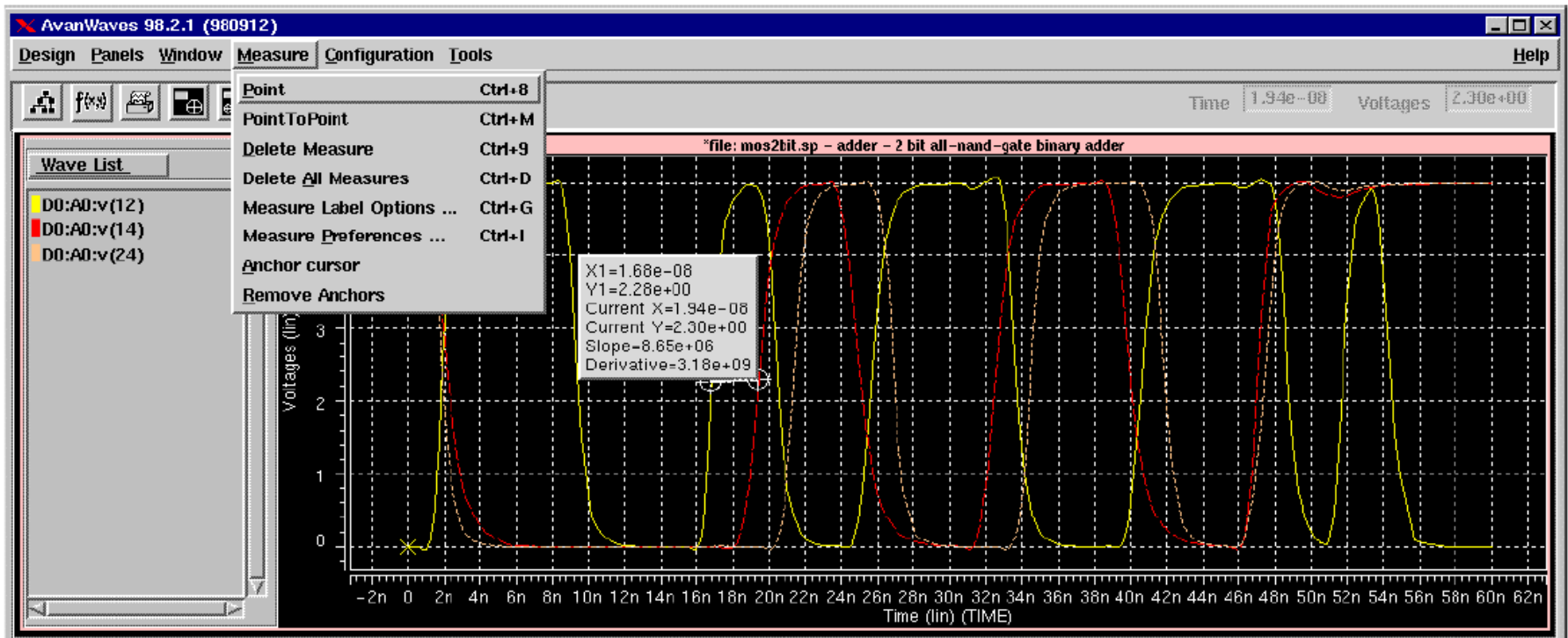

Multiple Panels

Multiple panels can be displayed on window

Maximum number of panels displayed depends on window size

Waveforms can be dragged and drop into other panels

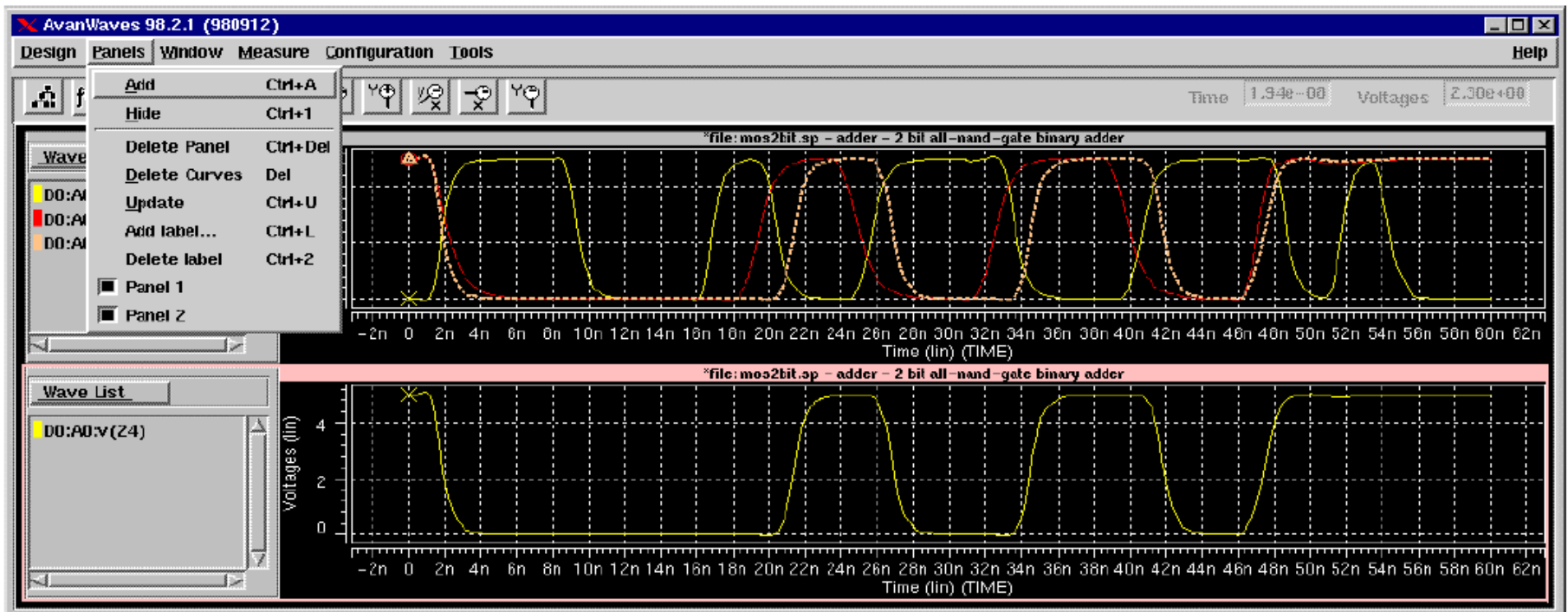

Zoom In

