

EE241B : Advanced Digital Circuits

Lecture 23 – Sleep Modes

Borivoje Nikolić



Wave Computing and MIPS Wave Goodbye

by Mike Gianfagna on 04-19-2020 at 8:00 Word on the virtual street is that Wave Computing is closing down. The company has reportedly let all employees go and filed for Chapter 11. As one of the many promising new companies in the field of AI, Wave Computing was founded in 2008 with the mission "to revolutionize deep learning with real-time AI solutions that scale from the edge to the datacenter."



<https://www.semiwiki.com>

Announcements

- Assignment 4 due on Friday.
- Reading
 - Rabaey, LPDE, Chapter 8



EECS241B L23 SLEEP

Outline

- Module 5
 - Sleep modes
 - Optimal thresholds and supplies



EECS241B L23 SLEEP

5.J Lowering Leakage During Design: Transistor Stacking

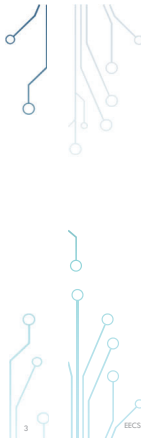

Power /Energy Optimization Space

	Constant Throughput/Latency		Variable Throughput/Latency
Energy	Design Time	Sleep Mode	Run Time
Active	Logic design Scaled V_{DD} Trans. sizing Multi- V_{DD}	Clock gating	DFS, DVS
Leakage	Stack effects Trans sizing Scaling V_{DD} + Multi- V_{Th}	Sleep T's Multi- V_{DD} Variable V_{Th} + Input control	+ Variable V_{Th}

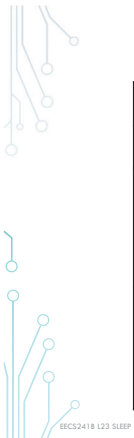

EECS241B L23 SLEEP

Stack Effect

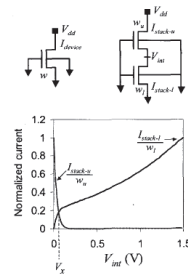

Reduction (in 0.13μ):

	High V_i	Low V_i
2 NMOS	10.7X	9.96X
3 NMOS	21.1X	18.8X
4 NMOS	31.5X	26.7X
2 PMOS	8.6X	7.9X
3 PMOS	16.1X	13.7X
4 PMOS	23.1X	18.7X

Narendra, ISLPED'01

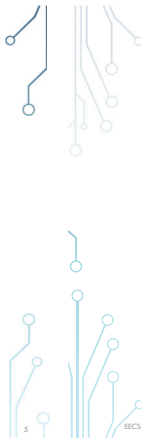

Stack Forcing

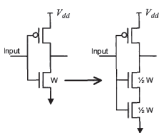

- Tradeoffs:
- $W/2 - 1/3$ of drive current, same loading
 - $1.5W - 3x$ loading, same drive current

Narendra, ISLPED'01



EECS241B L23 SLEEP

5.L Power Gating

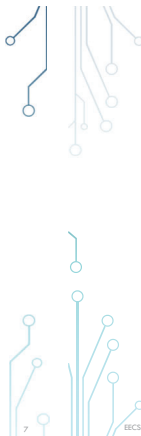

Power /Energy Optimization Space

	Constant Throughput/Latency		Variable Throughput/Latency
Energy	Design Time	Sleep Mode	Run Time
Active	Logic design Scaled V_{DD} Trans. sizing Multi- V_{DD}	Clock gating	DFS, DVS
Leakage	Stack effects Trans sizing Scaling V_{DD} + Multi- V_{Th}	Sleep T's Multi- V_{DD} Variable V_{Th} + Input control	+ Variable V_{Th}

Power Gating with Sleep Transistors

- Key components:
 - Power gates (& controller)
 - Leakage vs size
 - Switched cap
 - Slew-rate/rush current
 - State preservation
 - Energy overhead of sleep/wake-up transitions

How to Size the Sleep Transistor?

- Don't need both header and footer
- Circuits in active mode see the sleep transistor as extra power line resistance
 - The wider the sleep transistor, the better
- Wide sleep transistors cost area and are slow to turn on/off
 - Minimize the size of the sleep transistor for given ripple (e.g. 5%)
- Need to find the worst case vector
- Sleep transistor is not for free – it will degrade the performance in active mode
- Charging and discharging the virtual rails costs energy
- Need to sequentially wake up

Sleep Transistor

High-V_{TH} transistor (many in parallel) has to be very large for low resistance in linear region.
Low-V_{TH} transistor needs much less area for the same resistance.

	MTCMOS	Boosted Sleep	Non-Boosted Sleep
Sleep-TR size	5.1%	2.3%	3.2%
Leakage power reduction	1450X	3130X	11.5X
Virtual supply bounce	60 mV	59 mV	58 mV

Courtesy: R. Krishnamurthy, Intel

Sleep Transistor Layout



Sleep transistor cells

Area overhead	
PMOS	6%
NMOS	3%

Tschanz, ISSCC'03

Sleep in Standard Cells

	All HVT (<i>hvt_ND2</i>)	All LVT (<i>lvt_ND2</i>)	Footswitch (<i>fs_ND2</i>)
Schematics			
Perf.	1X	1.5X - 2X	1.4X - 1.8X
Leakage	1X	70X - 100X	≥ 1X
Area	1X	1X	1.25X

	All HVT (<i>hvt_ND2</i>)	Footswitch (<i>fs_ND2</i>)
Diagram		
SCHEMATICS		
LAYOUT		

Uviegahra, ISSCC'04

Sleep Transistor Grid

No sleep transistor

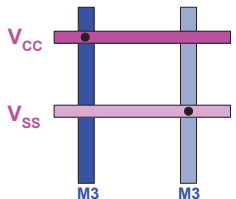

PMOS & NMOS sleep transistors

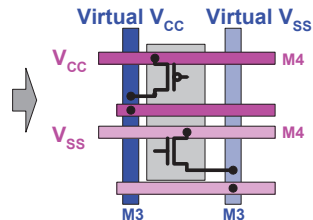

Tschanz, ISSCC'03

Power Gating

- No power gating
- "Ideal" power gating
- Realistic profile

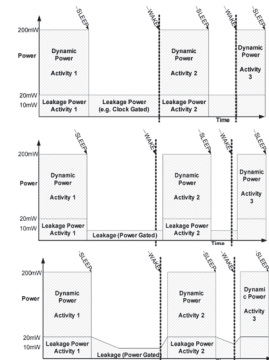

Keating, et al, Low Power Methodology Manual, 2009.

Preserving State

- Virtual supply collapse in sleep mode will cause the loss of state in registers
- Putting the registers at nominal VDD would preserve the state
 - These registers leak
 - The second supply needs to be routed as well
- Can lower VDD in sleep
 - Some impact on robustness, noise and SEU immunity
- State preservation and recovery

Scan-Based Retention

- Scan-out/scan-in state to preserve/restore state

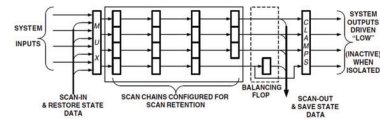

Keating, et al, Low Power Methodology Manual, 2009.

Retention Register Design

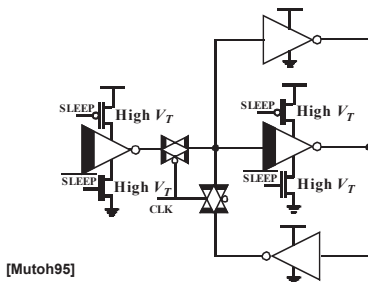

Gating Sequences

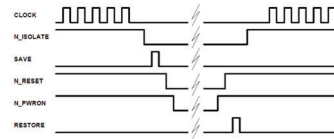

- Sequence of steps:
 - Gate clock
 - Isolate inputs
 - Save (scan out)
 - Reset
 - Gate power

Keating, et al, Low Power Methodology Manual, 2009.

Hierarchical Power Gating

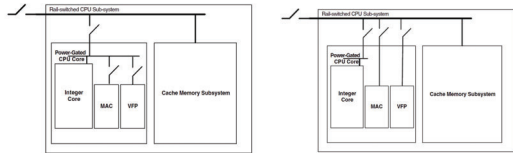

Cache	CPU	MAC	VFP	Power State
(OFF)	(OFF)	-	-	Shutdown (Cache cleaned, VDDCPU off)
ON	OFF	-	-	Deep Sleep (Cache preserved)
ON	ON	OFF	OFF	Normal Operation
ON	ON	ON	OFF	SOP workload
ON	ON	OFF	ON	Graphics workload
ON	ON	ON	ON	Intensive multimedia mode

Keating, et al, Low Power Methodology Manual, 2009.

Project reports

- Due May 4, up to 6 pages
- Presentations on May 4 in the afternoon
 - 12min + 3 min Q&A
 - 15min for 3-person teams

HECS2418 L23 SLEEP

22



5.M Dynamic Threshold Scaling

Power /Energy Optimization Space

	Constant Throughput/Latency		Variable Throughput/Latency	
Energy	Design Time	Sleep Mode	Run Time	
Active	Logic design Scaled V_{DD} Trans. sizing Multi- V_{DD}	Clock gating	DFS, DVS	
Leakage	Stack effects Trans sizing Scaling V_{DD} + Multi- V_{Th}	Sleep T_s Multi- V_{DD} Variable V_{Th} + Input control	DVS < Variable V_{Th}	

HECS2418 L23 SLEEP

24

Dynamic Body Bias

- Similar concept to dynamic voltage scaling
- Control loop adjusts the substrate bias to meet the timing/leakage goal
 - Can be used just as runtime/sleep
- Limited range of threshold adjustments in bulk (<100mV)
 - Limited leakage reduction (<10x)
- Works well in FDSOI (80-85mV/V, with ~1.8V range)
- No delay penalty
 - Can increase speed by forward bias
- Energy cost of charging/discharging the substrate capacitance
 - but doesn't need a regulator

FDSOI and Bulk



• Bulk CMOS

- Leakage paths through bulk
- RDF dominates local variability
- Diodes and B2B tunneling limit back-bias range

➢ UTBB FD-SOI

- Thin body for short-channel control
- No doping – less RDF
- Extended back-bias range

FDSOI Wells and Back Bias

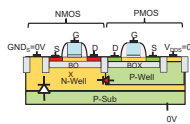
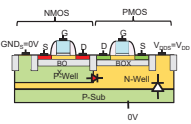

➢ Typical (RVT)

- $GND_{S,nom} = 0V, V_{DDS,nom} = V_{DD}$
- Reverse body bias, $V_{BSN} < 0V$
- $(-3V) < GND_S < V_{DD}/2 + 0.3V$
 - Limit due to diodes, BOX
- Can reverse bias 2-3V each

• Flip-well (LVT)

- $V_{DDS,nom} = GND_{S,nom} = 0V$
- Forward body bias $V_{BSN} > 0V$
- $0.3V < GND_S < (3V)$
 - Limit due to diodes, BOX
- Can forward bias 2-3V each

P. Flotresse, ISSCC'13

Back-Bias in FDSOI

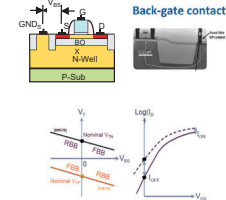
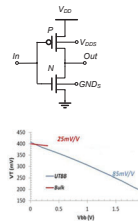

• $\gamma = 85mV/V$ body coefficient, and extended voltage range

- Lower coefficient and voltage range in bulk, finFET

D. Jacquet, ISSC 4/14

Multi V_{Th}

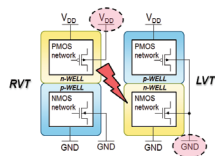

- No channel implant in 28FDSOI
 - No multi V_{Th}
- Can't abut wells
 - RVT and LVT require different well biases

D. Jacquet, ISSC 4/14

Back Bias in FDSOI

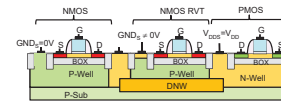

• Triple well (deep N-Well, DNW) allows for separate back bias

- Layout penalty; capacitance to drive

Digital Logic: UPF

- Supply, back-bias defined in Universal Power Format (UPF)
 - Or Common Power Format (CPF)
- Handled by synthesis, place and route tools

```
UPF description of PT_TOP with GND, VDD, DNW and VDD5 supplies.
create_govern_domain PT_TOP
create_supply_pnet GND
create_supply_pnet VDD
create_supply_net GND-domain PT_TOP
create_supply_net GND-domain GND
create_supply_net VDD-domain VDD
create_supply_net VDD5-domain VDD5
set_domain_supply_net PT_TOP-primary_govern_net VDD-primary_govern_net GND

# Body-bias specification
create_supply_pnet VDD5
create_supply_pnet GND5
create_supply_net VDD5-domain PT_TOP
create_supply_net VDD5-domain VDD5
create_supply_net GND5-domain PT_TOP
create_supply_net GND5-domain GND5
create_supply_net GND5-domain VDD5-domain VDD5

create_supply_net back_bias_net1
function (well VDD5)
function (well GND5)
reference_and (GND5)

create_govern_domain PT_TOP-upf6m-supply-bias
create_supply_net back_bias_net1=VDD5
M.Blažević, Ph.D. Dissertation, ISEP 2017
```

Digital Logic - Implementation

- Well taps added explicitly
 - Difference from bulk

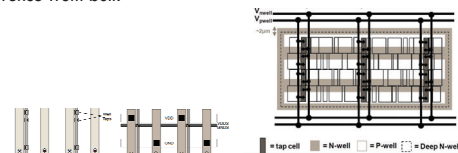

➢ Back bias straps

- Low DC current
- Except for very fast transitions

Dynamic Body Bias (Bulk)

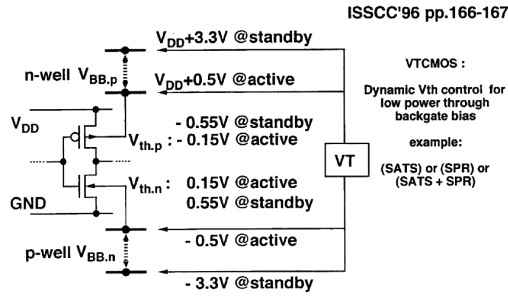

Dynamic Body Bias (Bulk)

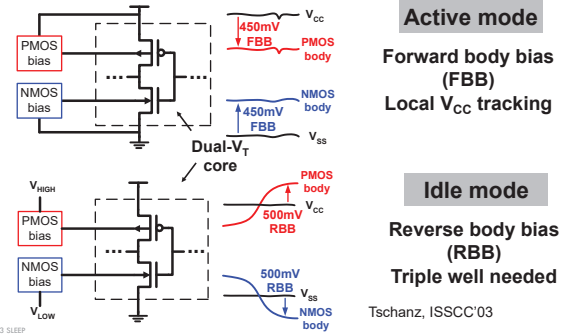

Body Bias Layout

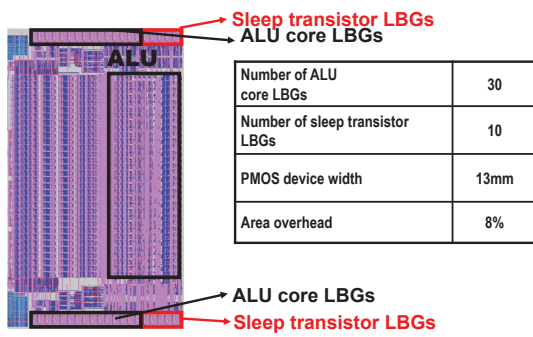

Total Active Power Savings

(Fixed activity: $\alpha = 0.05$)

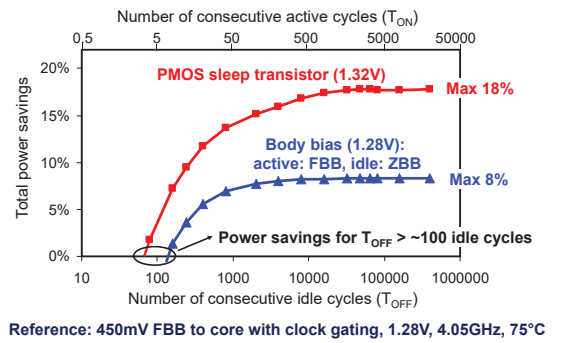

Generating Back-Bias

- Tradeoff – speed of charging and discharging well caps
- Often measure V_{BB} indirectly (leakage)
- Challenge: Generating $-V_{SS}$
- 28nm FDSOI implementation

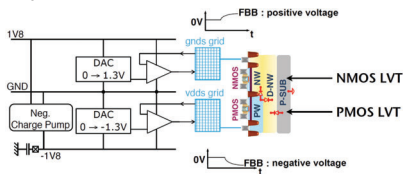

D. Jacquet, VLSI 2013

Generating Back Bias

- Fast and wide voltage range back-bias in FDSOI

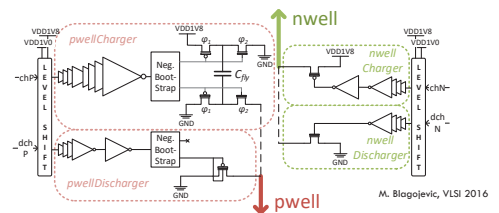

Supply/Process Compensation

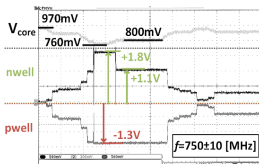

- Able to track $\sim 200mV$ supply droops and maintain constant frequency (measured by a replica) by back-bias adjustments

5.N Dynamic Threshold Scaling and Variations



Body Biasing and Variations

- Body biasing with a local control loop can be used to lower the impact of process variations
- Used to limit die-to-die and within-die variations

Self-Adjusting Threshold-Voltage Scheme (SATS)

- Older bulk technologies had stronger body effect

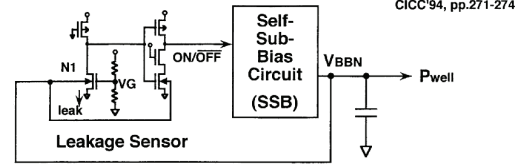

low V_{th} → large leakage → SSB ON → deep V_{BB} → high V_{th}
 high V_{th} → little leakage → SSB OFF → shallow V_{BB} → low V_{th}

- control V_{th} to adjust leakage current
- compensate V_{th} fluctuation

Dynamic Frequency Loop in FDSOI

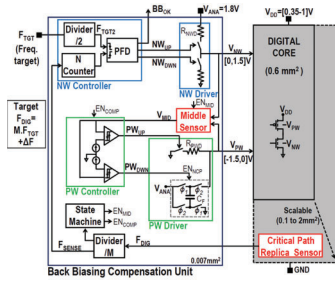

Quelen, ISSCC'18

Substrate Biasing

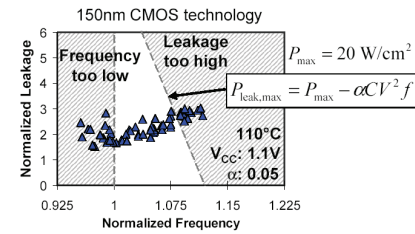

Tschanz, JSSC 11/02

Effectiveness of Substrate Bias

Die-to-die variations

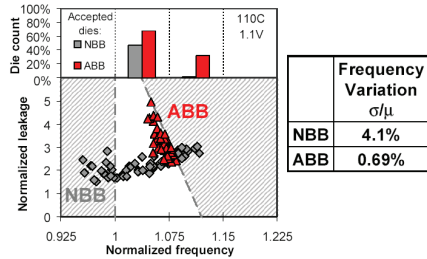

- NBB: No body bias
- ABB: Adaptive body bias

Effectiveness of Substrate Bias

Within-die variations

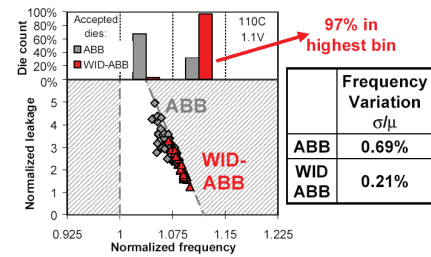

- ABB with multiple within die (WID) sensors

Techniques Summary (around 130nm node)

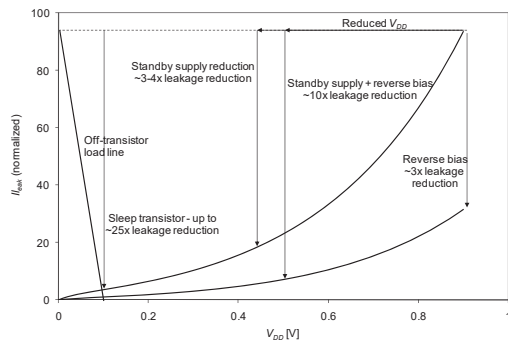

Power /Energy Optimization Space

	Constant Throughput/Latency		Variable Throughput/Latency	
Energy	Design Time	Sleep Mode	Run Time	
Active	Logic design Scaled V_{DD} Trans. sizing Multi- V_{DD}	Clock gating	DFS, DVS	
Leakage	Stack effects Trans sizing Scaling V_{DD} + Multi- V_{th}	Sleep T's Multi- V_{DD} Variable V_{th} + Input control	+ Variable V_{th}	



5.0 Optimal V_{DD} , V_{Th}

Dynamic Voltage Scaled Microprocessor

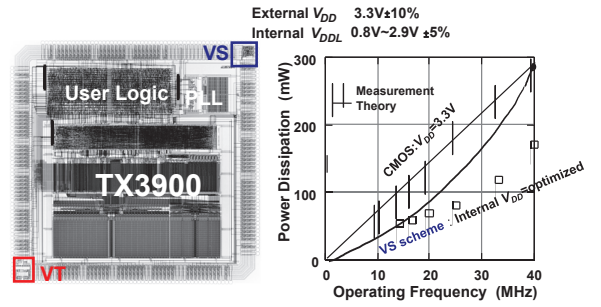

Courtesy: Prof. Kuroda

Adapting V_{DD} and V_{Th}

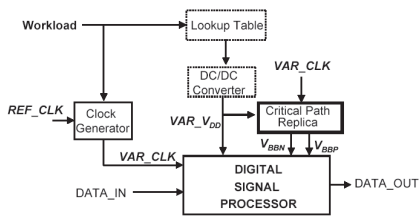

- Adapting both V_{DD} and V_{Th} during runtime
- V_{Th} is much less sensitive

Miyazaki, ISSCC'02

Adapting V_{DD} and V_{Th}

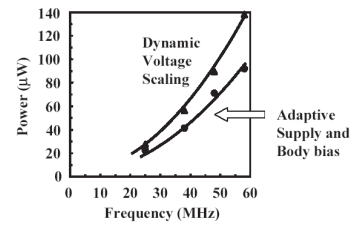

Miyazaki, ISSCC'02

Optimal V_{DD} , V_{Th}

- Adjusting V_{DD} , V_{Th} trades of energy and delay
- We studied energy-limited design
 - And alternate ways for optimizing energy and delay together
 - E.g. energy-delay product (EDP)
 - Or $E^n D^m$, $n, m > 1$

Optimal EDP Contours

- Plot of EDP curves in V_{DD} , V_{Th} plane

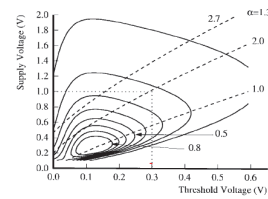

Gonzalez, JSSC 8/97

Sizing, Supply, Threshold Optimization

Reference Design:	Topology	Inverter	Adder	Decoder
$D^{ref} (V_{dd}^{max}, V_{th}^{ref})$	$(E_{LJ}/E_{SW})^{ref}$	0.1%	1%	10%

Large variation in optimal circuit parameters V_{dd}^{opt} , V_{th}^{opt} , w^{opt}

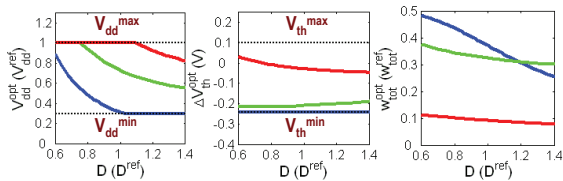

Technology parameters (V_{dd}^{max} , V_{th}^{ref}) rarely optimal

Result: E-D Tradeoff in an Adder

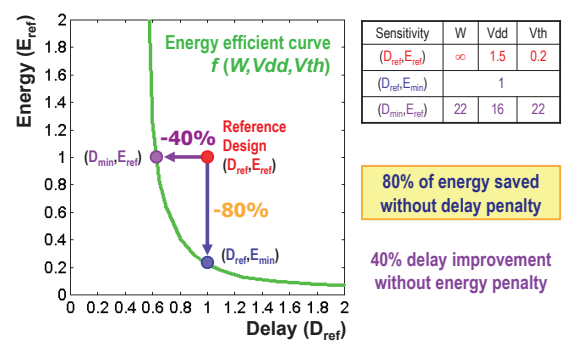

55

56

Energy-constrained delay

- Active power

$$P_{act} = \alpha f C V_{DD}^2$$

$$f = 1/L_D t_p$$

- Leakage power

$$P_{leak} = I_0 e^{\frac{-V_{Th} - \gamma V_{DD}}{S}} V_{DD}$$

- Eliminate one variable (V_{Th}) and find $P_{min}(V_{DD})$

Nose, ASP-DAC'00

EECS241B L23 SLEEP

Minimum energy: $E_{Sw} = 2E_{Lk}$

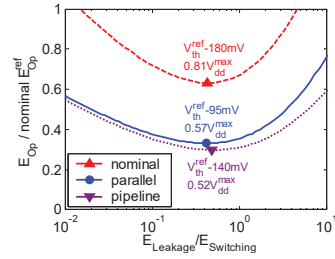

- Large $(E_{Lk}/E_{Sw})^{opt}$
- Flat E_{Op} minimum
- Topology dependent

$$(E_{Lk}/E_{Sw})_{opt} = \frac{2}{\ln\left(\frac{L_d}{\alpha_{avg}}\right) - K}$$

Optimal designs have high leakage ($E_{Lk}/E_{Sw} \approx 0.5$)

Subthreshold Optimum

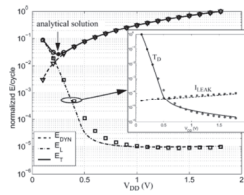

$f = 30kHz$

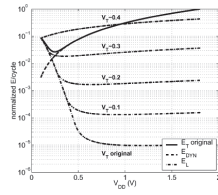

Minimum is independent of V_T

Calhoun, JSSC 9/05

EECS241B L23 SLEEP

Next Lecture

- We finished low-power design
- Next is clocks and supplies

59

EECS241B L23 SLEEP

60