

EE C245 - ME C218 Introduction to MEMS Design Fall 2011

Prof. Clark T.-C. Nguyen

Dept. of Electrical Engineering & Computer Sciences
University of California at Berkeley
Berkeley, CA 94720

Lecture Module 2: Benefits of Scaling

EE_C245: Introduction to MEMS Design LecM 2 C. Nguyen 8/20/09 1



Lecture Outline

- Reading: Senturia, Chapter 1
- Lecture Topics:
 - ↳ Benefits of Miniaturization
 - ↳ Examples
 - GHz micromechanical resonators
 - Chip-scale atomic clock
 - Micro gas chromatograph

EE_C245: Introduction to MEMS Design LecM 2 C. Nguyen 8/20/09 2

 **Benefits of Size Reduction: MEMS**

- Benefits of size reduction clear for IC's in elect. domain
↳ size reduction ⇒ speed, low power, complexity, economy
- MEMS: enables a similar concept, but ...
MEMS extends the benefits of size reduction beyond the electrical domain



Performance enhancements for application domains beyond those satisfied by electronics in the same general categories

- Speed → Frequency ↑ , Thermal Time Const. ↓
- Power Consumption → Actuation Energy ↓ , Heating Power ↓
- Complexity → Integration Density ↑ , Functionality ↑
- Economy → Batch Fab. Pot. ↑ (esp. for packaging)
- Robustness → g-Force Resilience ↑

EE_C245: Introduction to MEMS Design LecM 2 C. Nguyen 8/20/09 3

 **Vibrating RF MEMS**

Vibrating RF MEMS

EE_C245: Introduction to MEMS Design LecM 2 C. Nguyen 8/20/09 4

Basic Concept: Scaling Guitar Strings

Guitar String

Vib. Amplitude vs Freq. (110 Hz)

Vibrating "A" String (110 Hz)

Freq. Equation:

$$f_o = \frac{1}{2\pi} \sqrt{\frac{k_r}{m_r}}$$

Labels: Stiffness (k_r), Mass (m_r), Freq. (f_o)

μ Mechanical Resonator

Metallized Electrode, Anchor, Polysilicon Clamped-Clamped Beam, Dimensions: W_r , L_r , h_r

[Bannon 1996]

Performance:

- $L_r = 40.8 \mu\text{m}$
- $m_r \sim 10^{-13} \text{ kg}$
- $W_r = 8 \mu\text{m}$, $h_r = 2 \mu\text{m}$
- $d = 1000 \text{ \AA}$, $V_p = 5 \text{ V}$
- Press. = 70 mTorr

EE C245: Introduction to MEMS Design

Frequency of a Stretched Wire

Scaling of Guitar Strings!
 guitar string \equiv transversely vibrating stretched wire

B.C. Simple Support $z(x=0)=0$, $z(x=L)=0$

\Rightarrow Equation for Resonance Freq. (fundamental mode)

$$f_1 = \frac{1}{2L} \sqrt{\frac{S}{\rho}}$$

Labels: S = tension (force per unit area), ρ = mass per unit length

This is a good approx. for a guitar string \rightarrow but for the MEMS device, thickness might approach length \rightarrow better described as a beam (length much larger than thickness)

EE C245: Introduction to MEMS Design LecM 2 C. Nguyen 8/20/09

UC Berkeley **Frequency of a Clamped-Clamped Beam**

Clamped-Clamped Beam

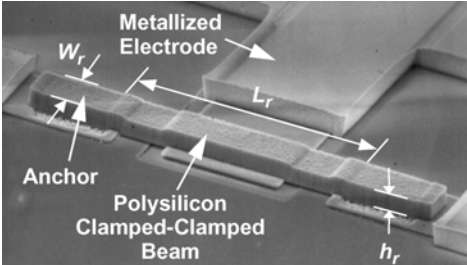
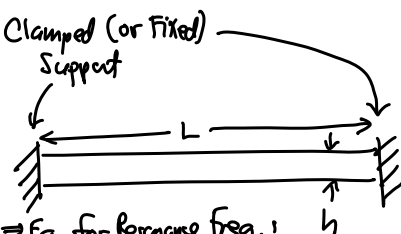
⇒ Eq. for Resonance Freq. 1

$$f_0 = \frac{1}{2\pi} \sqrt{\frac{k}{m}} = 1.03 \sqrt{\frac{E}{\rho}} \frac{h}{L^2} \quad (1)$$

where $E \hat{=}$ Young's modulus [GPa]
 $\rho \hat{=}$ density [kg/m³]
 $h \hat{=}$ thickness [m]
 $L \hat{=}$ length [m]

Example. $L = 40 \mu\text{m}$, $h = 2 \mu\text{m}$
 polysi $\rightarrow E = 150 \text{ GPa}$, $\rho = 2300 \text{ kg/m}^3$

$$\therefore f_0 = (1.03) \sqrt{\frac{1506}{2300}} \frac{2\mu}{(40\mu)^2} \rightarrow \boxed{f_0 = 10.4 \text{ MHz}}$$

acoustic velocity = 8076 m/s As $L \downarrow \rightarrow f_0 \uparrow$!

EE C245: Introduction to MEMS Design LecM 2 C. Nguyen 8/20/09 7

UC Berkeley **Frequency of a Clamped-Clamped Beam**

Example. $L = 4 \mu\text{m} \rightarrow f_0 = (1.03)(8076) \frac{2\mu}{(4\mu)^2} \rightarrow \boxed{f_0 = 1.04 \text{ GHz}}$

Remarks.

- ① Eq. (1) not accurate when $L \approx h$. (See HW#1)
- ② When $L \approx h$ (a when it isn't more than $10 \times h$), anchor losses become an issue

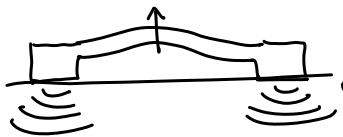

Anchor Radiation \rightarrow lowers quality factor, Q

- ③ Solution: non-dimensional? ✓
- ④ Better Solution: other geometries ✓

Smaller \downarrow Faster!

GHz freqs. possible!

EE C245: Introduction to MEMS Design LecM 2 C. Nguyen 8/20/09 8

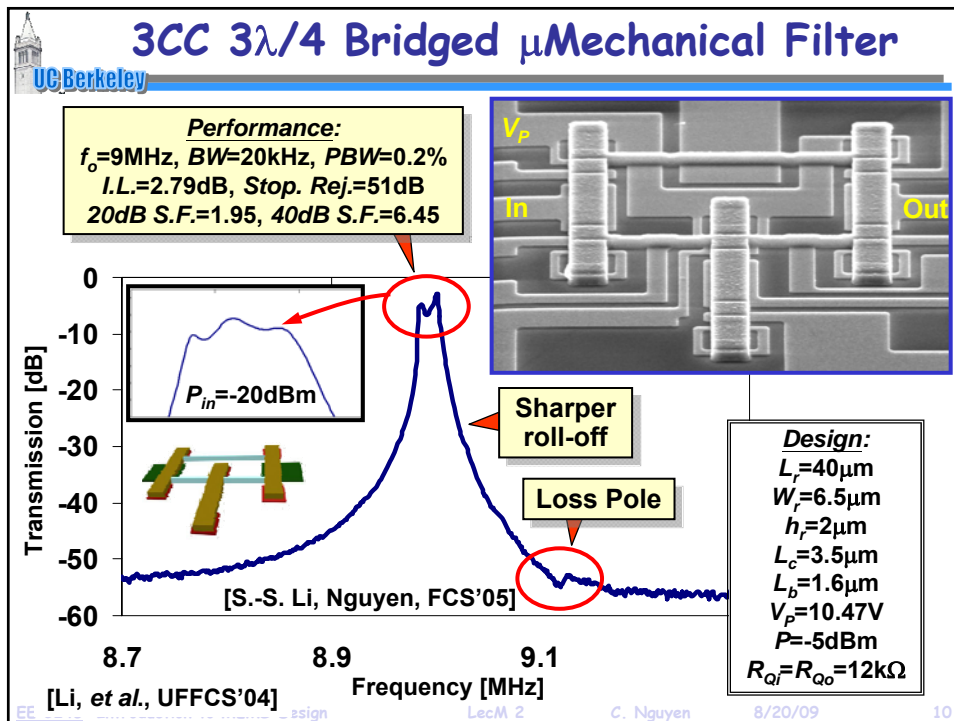
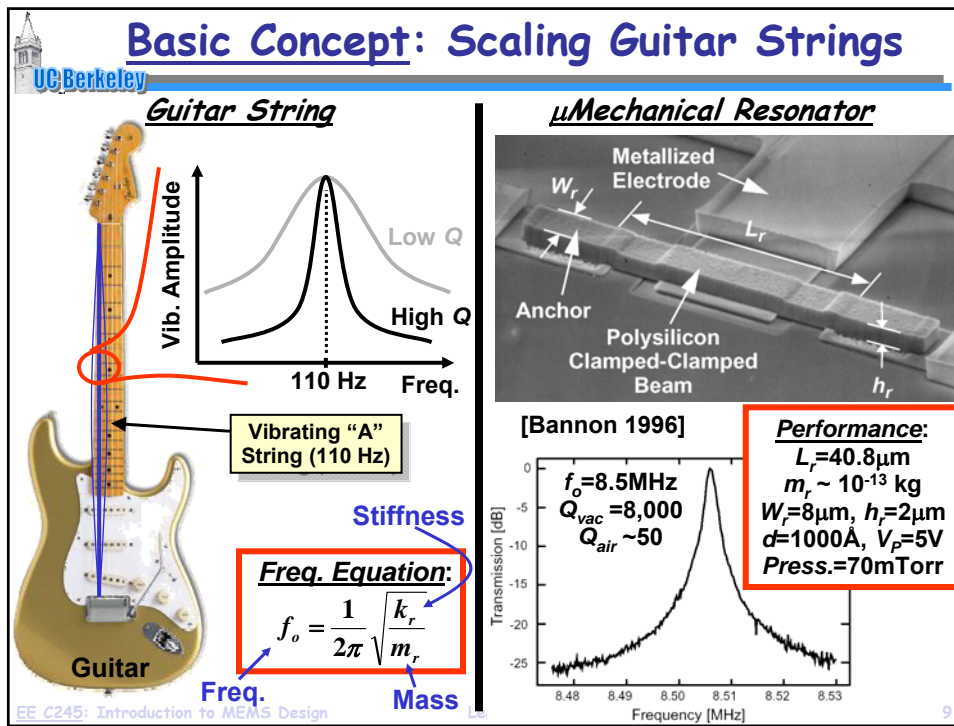

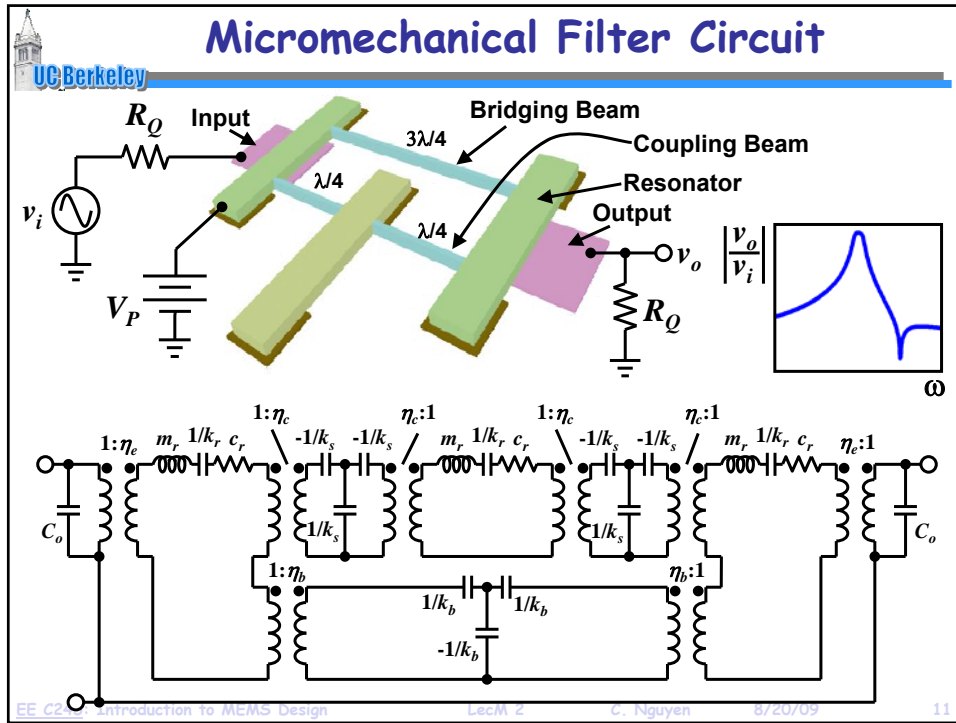

1.51-GHz, Q=11,555 Nanocrystalline Diamond Disk μ Mechanical Resonator

- Impedance-mismatched stem for reduced anchor dissipation
- Operated in the 2nd radial-contour mode
- Q ~11,555 (vacuum); Q ~10,100 (air)
- Below: 20 μ m diameter disk

Design/Performance:

$R=10\mu\text{m}$, $t=2.2\mu\text{m}$, $d=800\text{\AA}$, $V_p=7\text{V}$
 $f_o=1.51\text{ GHz}$ (2nd mode), $Q=11,555$

Mixed Amplitude [dB]

Frequency [MHz]

$f_o = 1.51\text{ GHz}$
 $Q = 11,555\text{ (vac)}$
 $Q = 10,100\text{ (air)}$

[Wang, Butler, Nguyen MEMS'04]

EE C245: Introduction to MEMS Design LecM 2

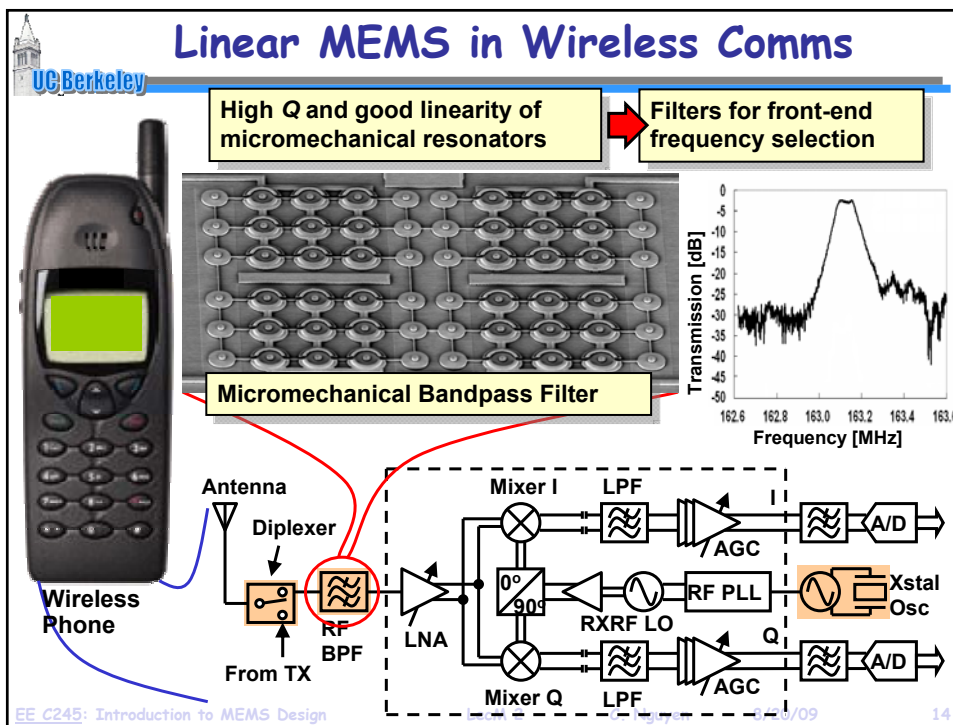
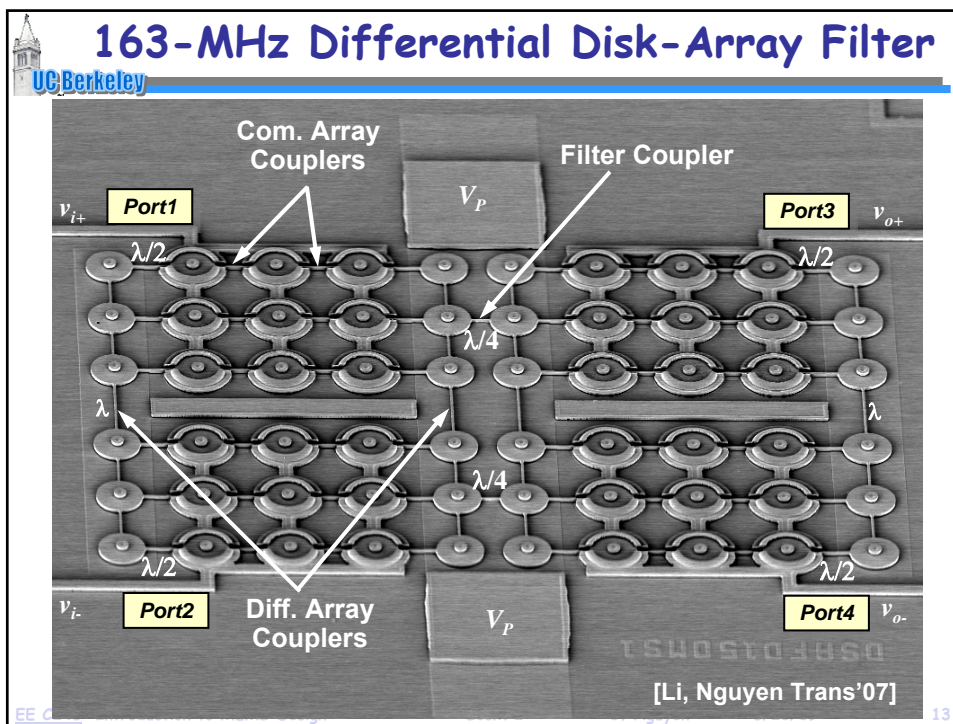

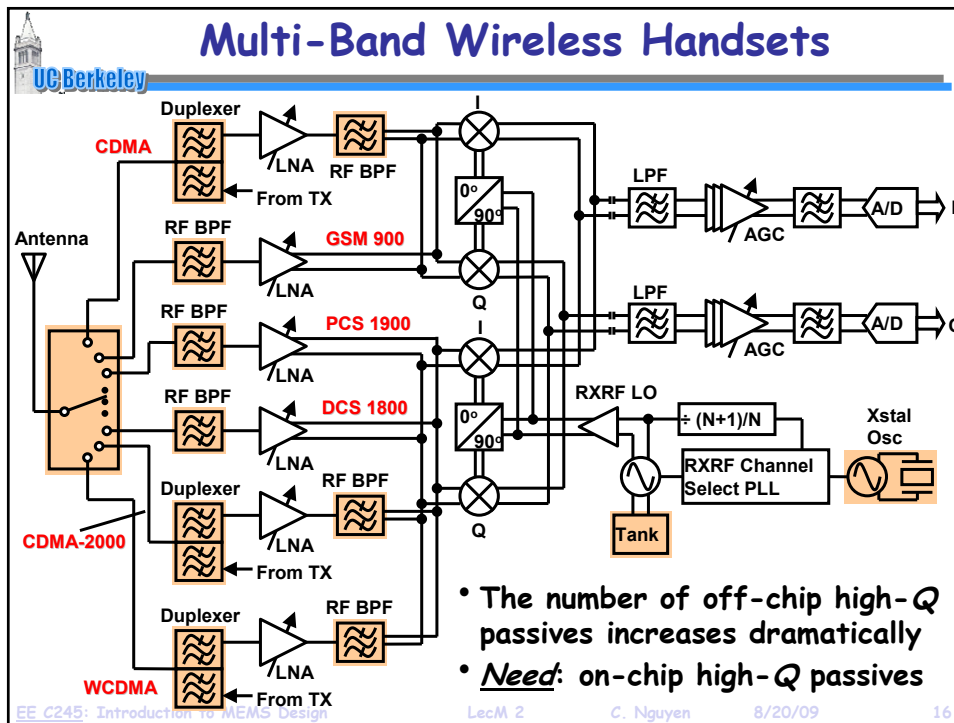
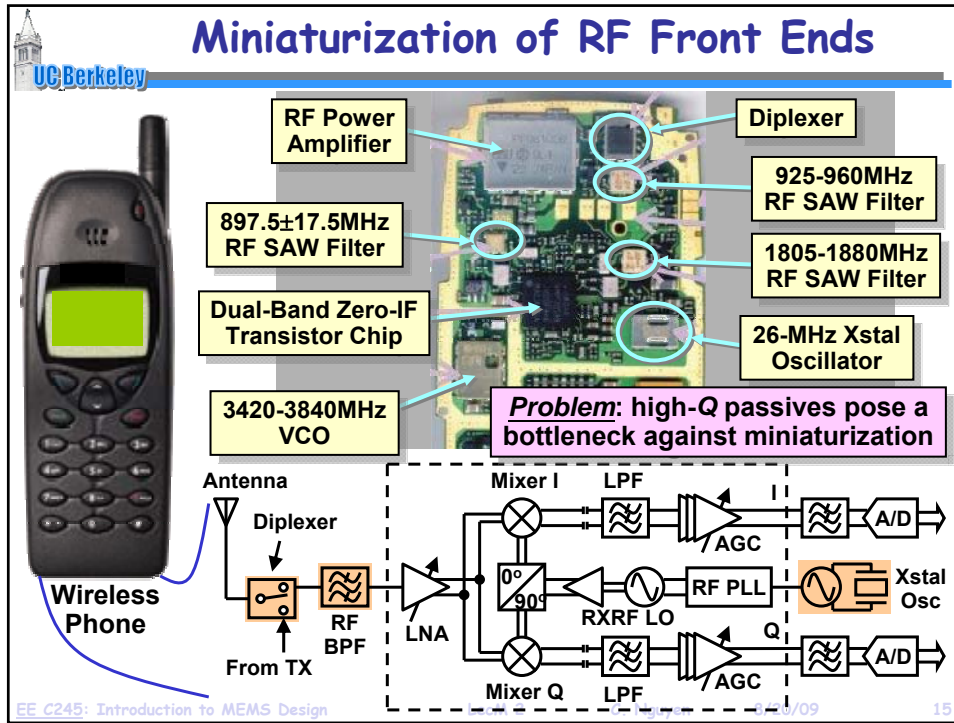

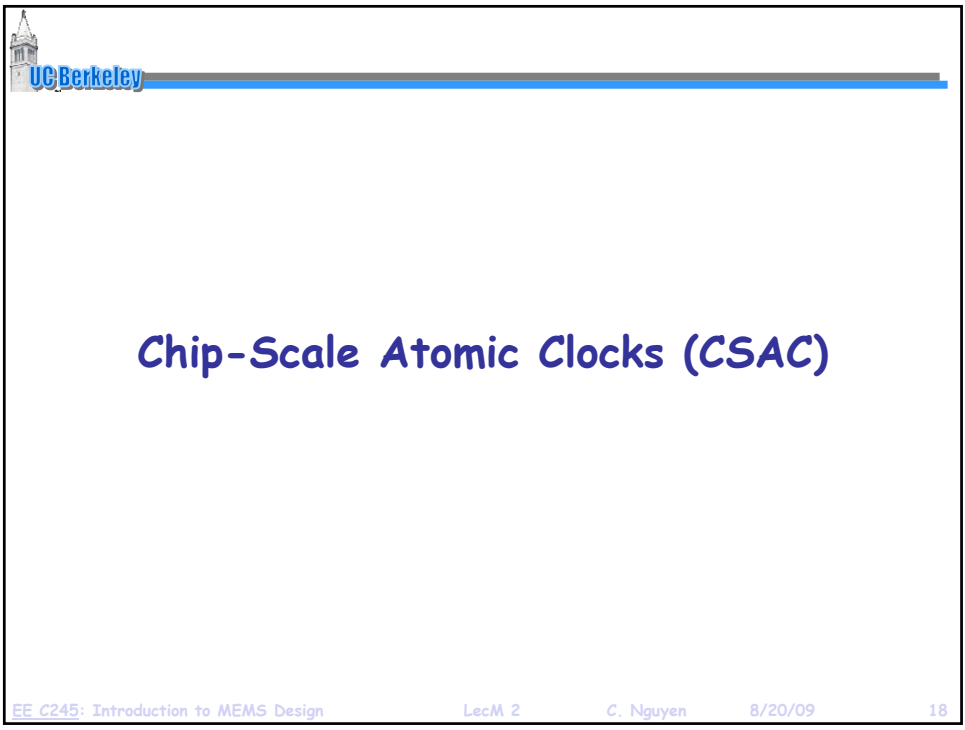
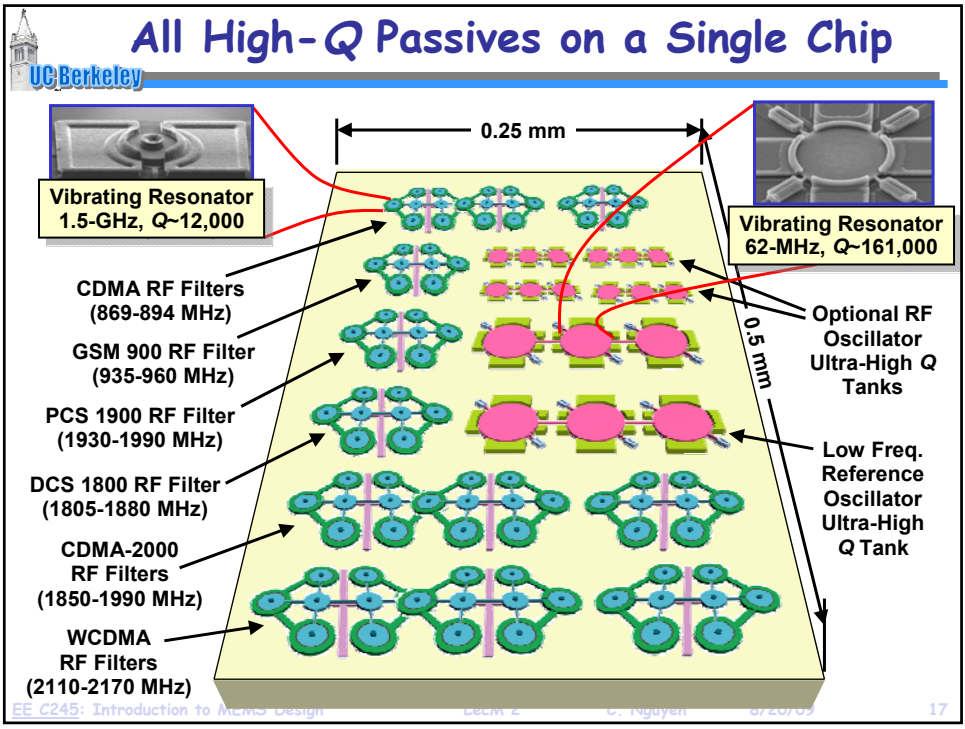

NIST F1 Fountain Atomic Clock

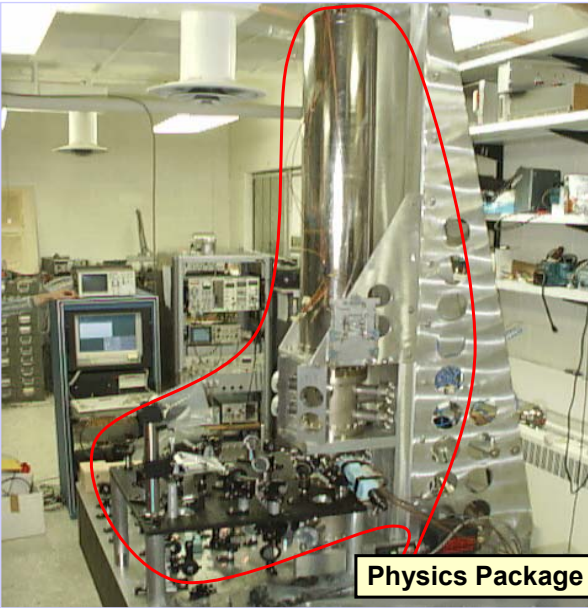

Vol: $\sim 3.7 \text{ m}^3$
 Power: $\sim 500 \text{ W}$
 Acc: 1×10^{-15}
 Stab: $3.3 \times 10^{-15}/\text{hr}$

After 1 sec \Rightarrow
 Error: 10^{-15} sec

Loses 1 sec every
 30 million years!

Physics Package

EE C245: Introduction to MEMS Design
EEEM 2
C. Nguyen
8/20/09
19

Benefits of Accurate Portable Timing

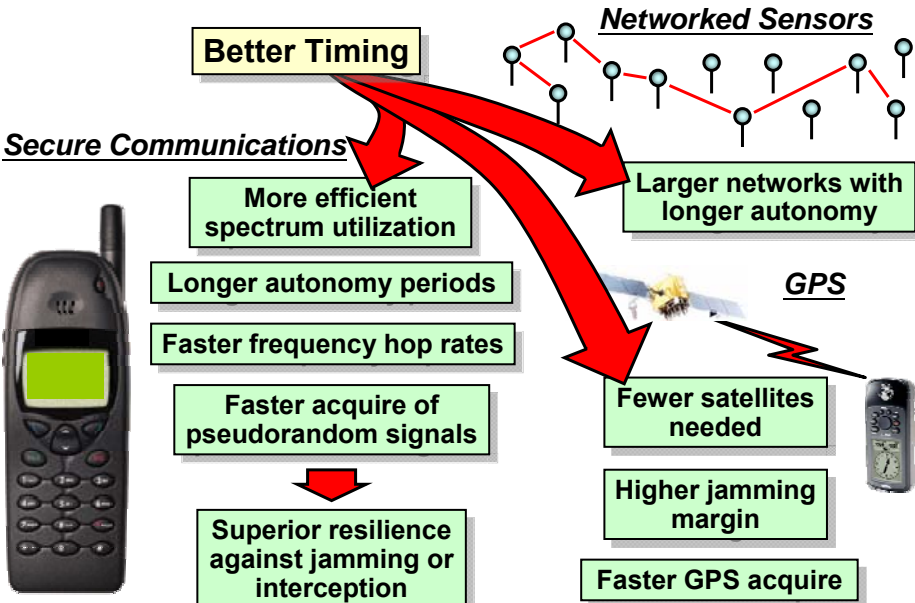

Better Timing

Secure Communications

- More efficient spectrum utilization
- Longer autonomy periods
- Faster frequency hop rates
- Faster acquire of pseudorandom signals
- Superior resilience against jamming or interception

Networked Sensors

- Larger networks with longer autonomy

GPS

- Fewer satellites needed
- Higher jamming margin
- Faster GPS acquire

EE C245: Introduction to MEMS Design
EEEM 2
C. Nguyen
8/20/09
20

NIST F1 Fountain Atomic Clock

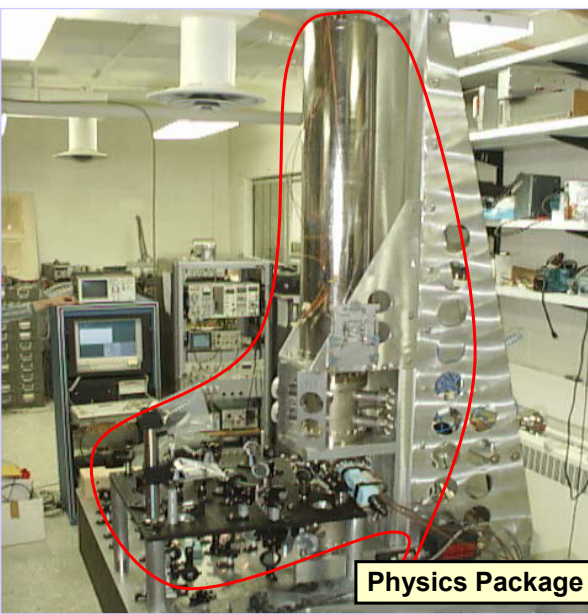

Vol: $\sim 3.7 \text{ m}^3$
 Power: $\sim 500 \text{ W}$
 Acc: 1×10^{-15}
 Stab: $3.3 \times 10^{-15}/\text{hr}$

After 1 sec \Rightarrow
 Error: 10^{-15} sec

Loses 1 sec every
 30 million years!

Physics Package

EE C245: Introduction to MEMS Design
Lect 2
C. Nguyen
8/20/09
21

1st Chip-Scale Atomic Physics Package

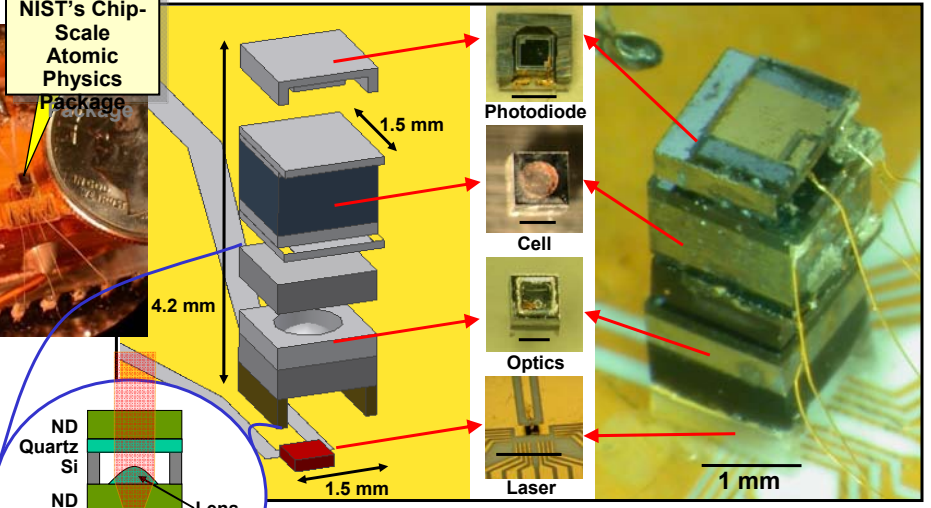

Total Volume: 9.5 mm^3 Stability: 2.4×10^{-10} @ 1s
 Cell Interior Vol: 0.6 mm^3 Power Cons: 75 mW

EE C245: Introduction to MEMS Design
Lect 2
C. Nguyen
8/20/09
22

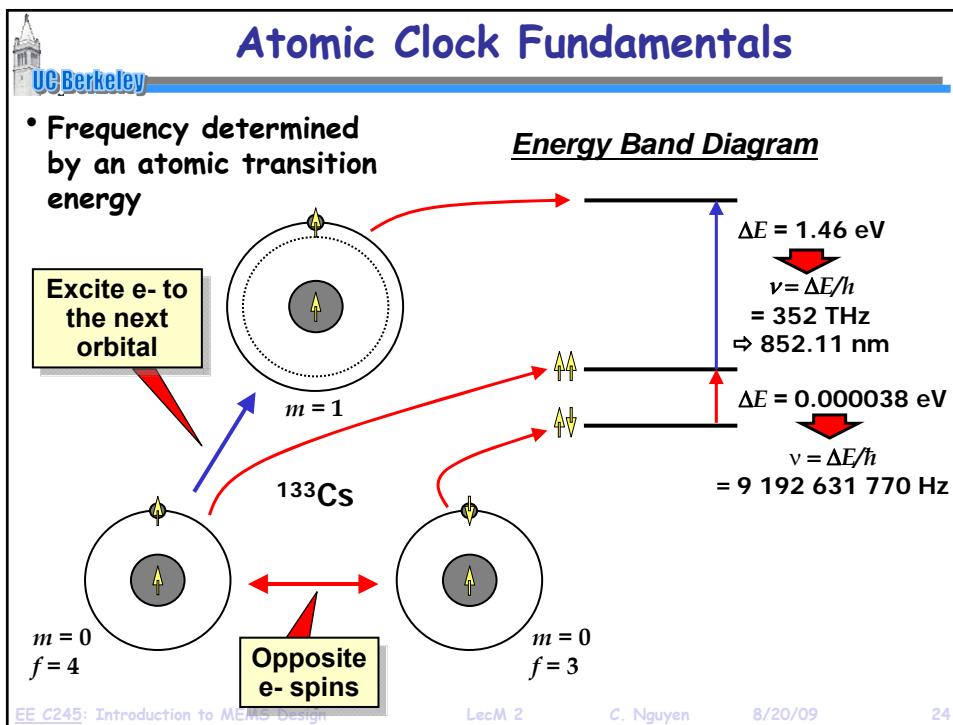
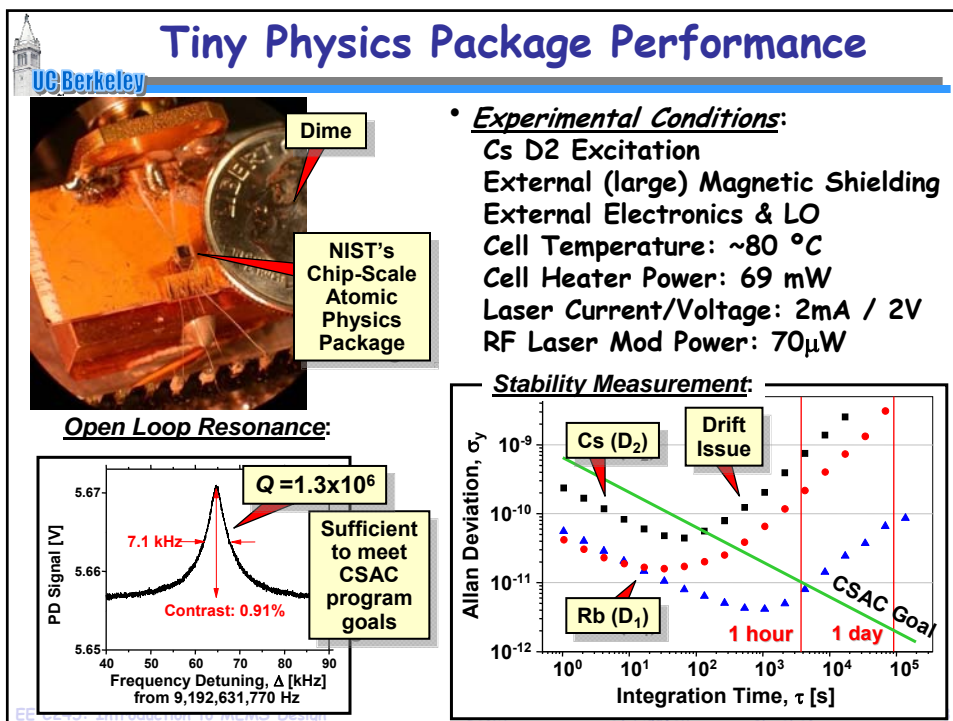

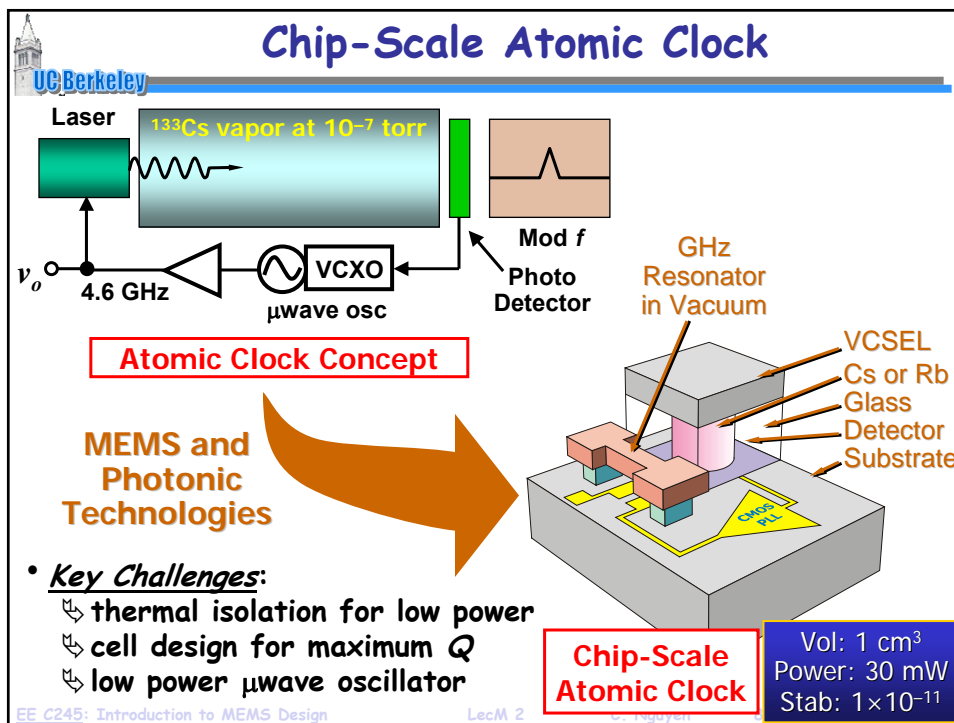
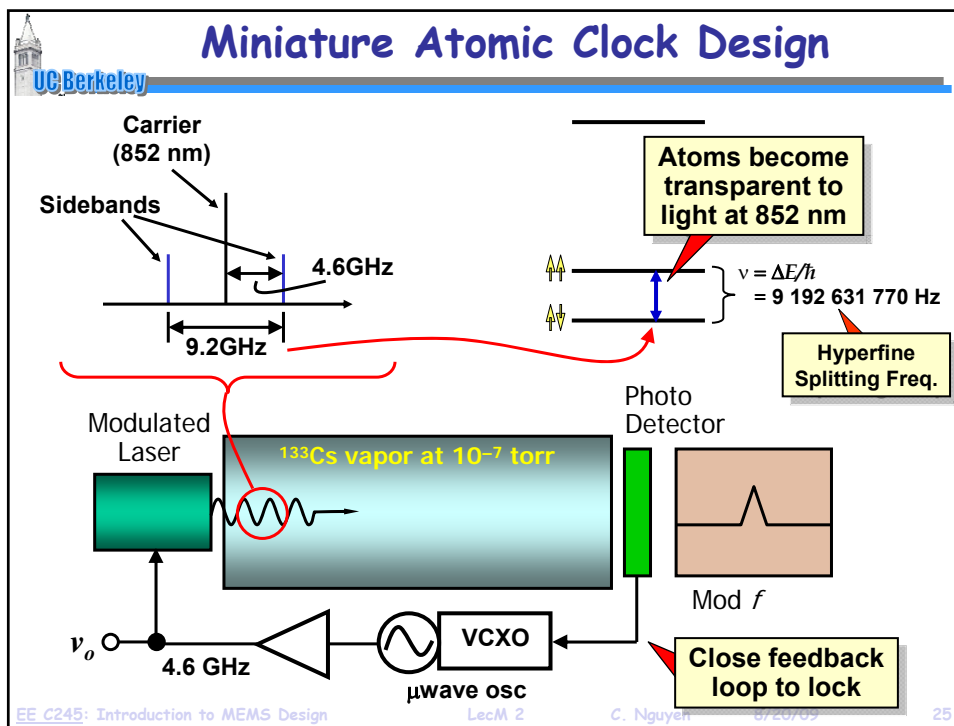

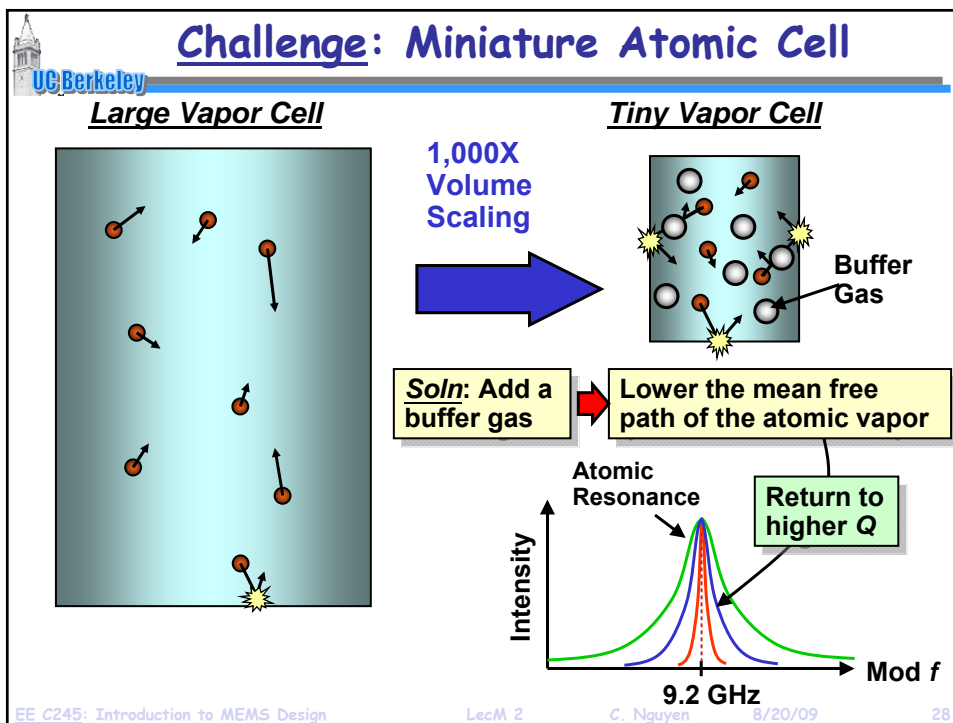
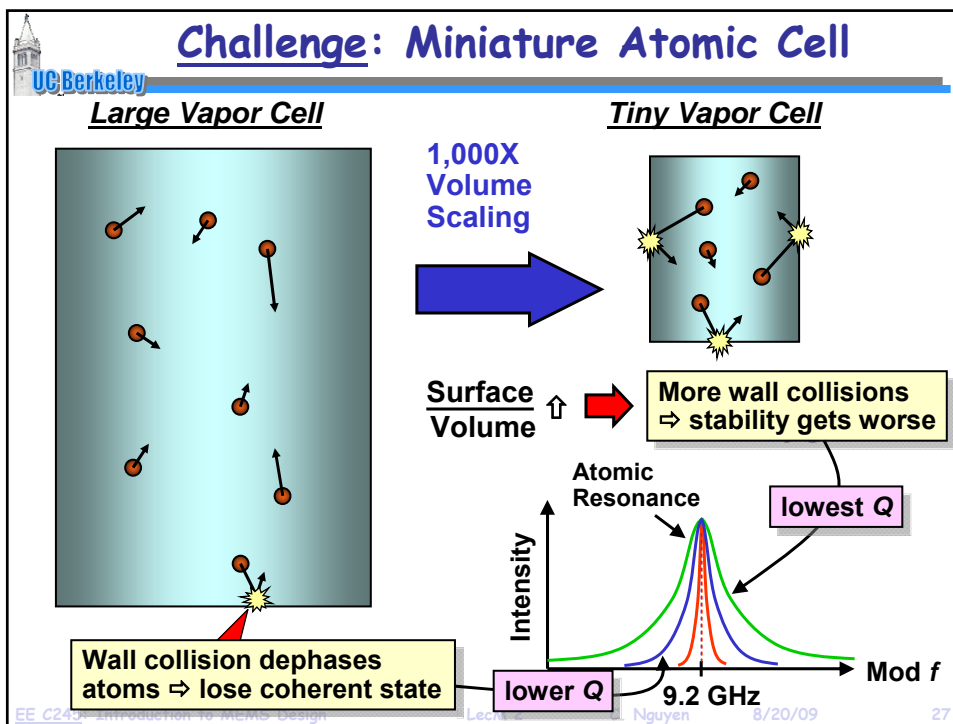

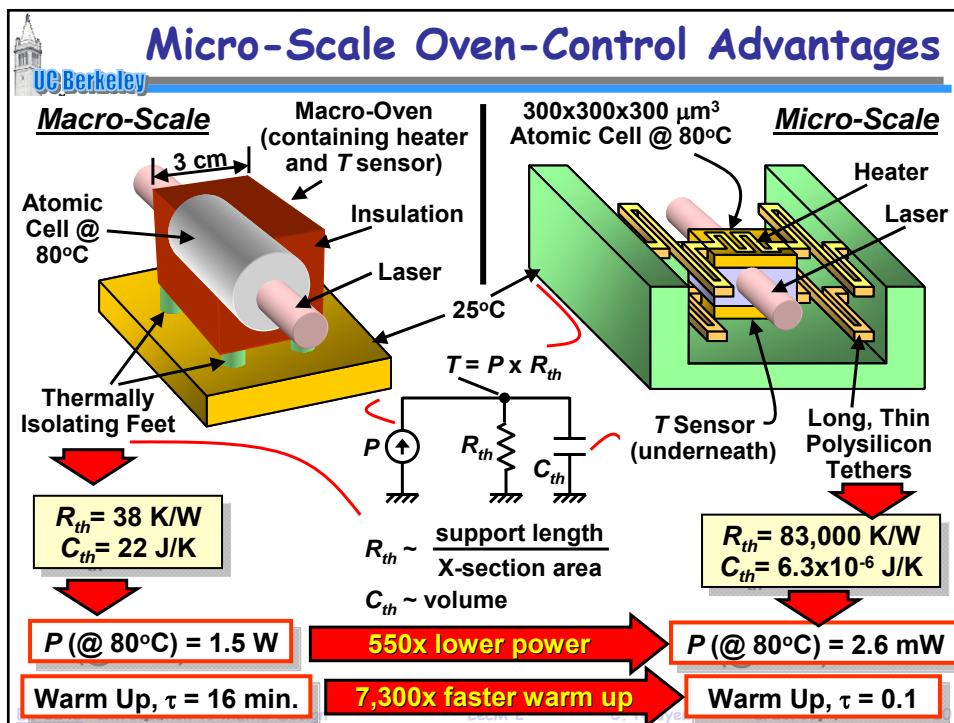
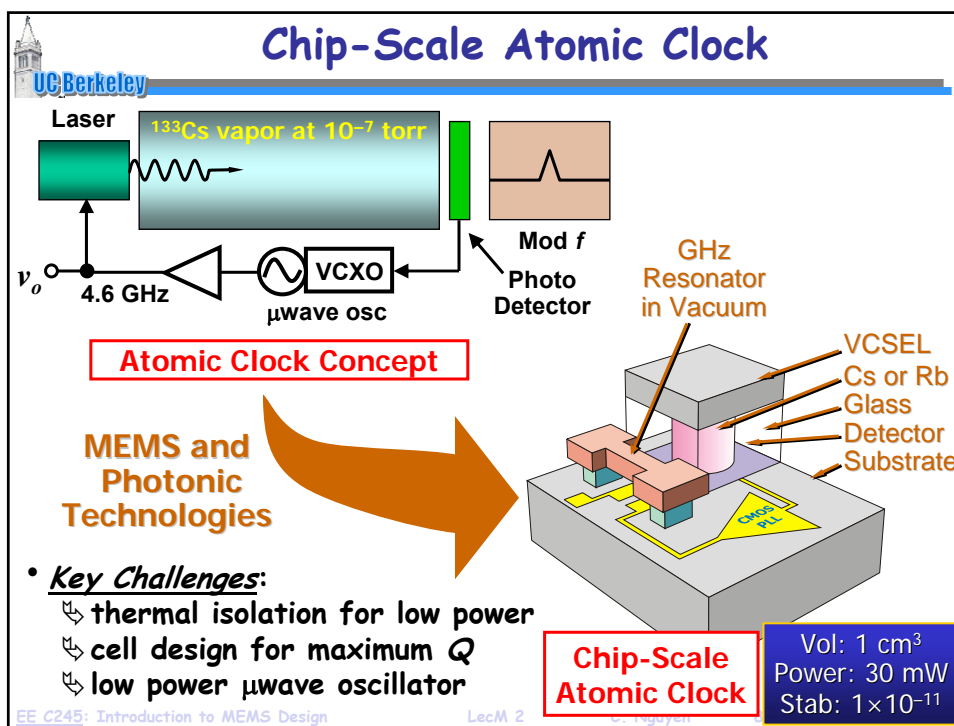

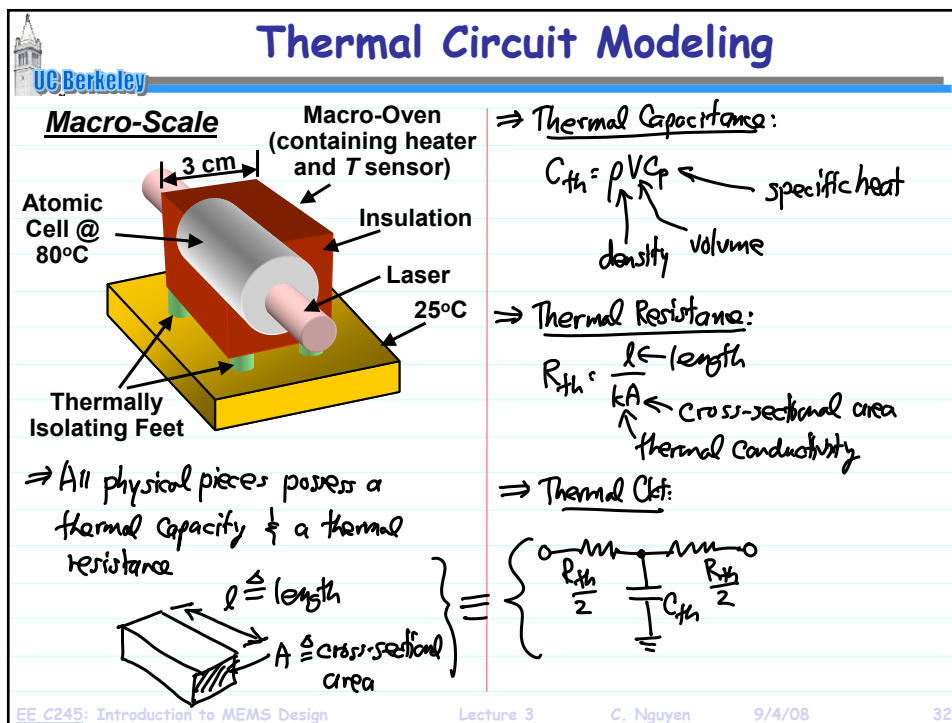
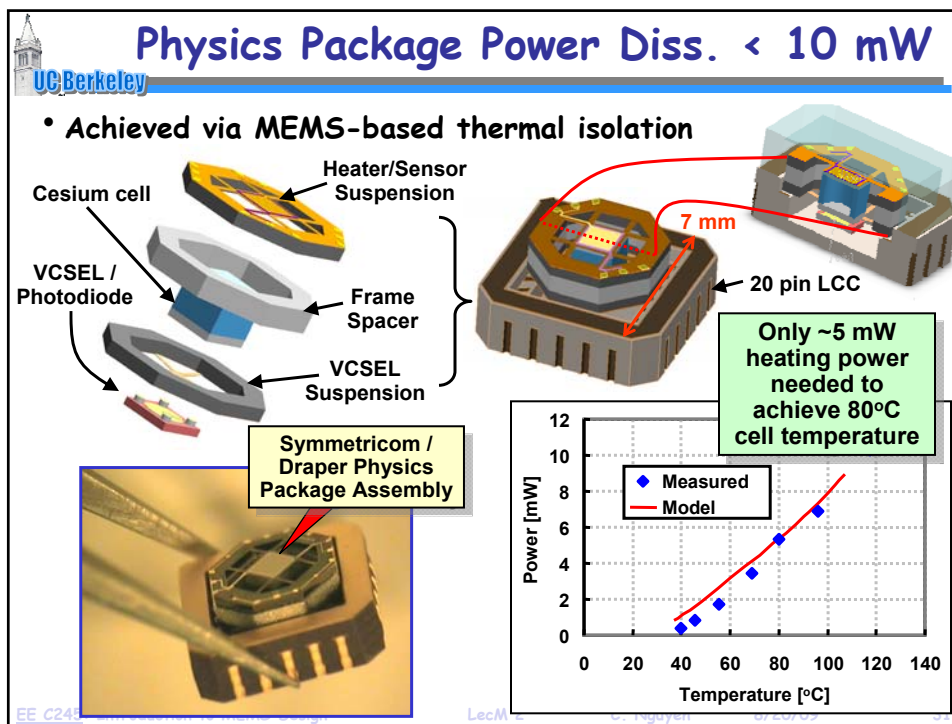

Thermal Circuit Modeling

Example: Power to maintain cell $T > 80^\circ\text{C}$
 \Rightarrow for materials identified in the figure: (all glass)

$C_{p, \text{glass}} = 0.5 \text{ J/(g}\cdot\text{K)}$
 $\rho_{\text{glass}} = 2500 \text{ kg/m}^3$

$k_{\text{glass}} = 1.05 \frac{\text{W}}{\text{m}\cdot\text{K}}$

Eq. iv. Ckt:
 \Rightarrow ignore the small R_{th} of the cell
 \Rightarrow ignore the small C_{th} of the feet

EE C245: Introduction to MEMS Design
Lecture 3
C. Nguyen
9/4/08
33

Thermal Circuit Modeling

\Rightarrow When power is switched on

Find $C_{\text{th, cell}}$:
 \Rightarrow Find volume of the cell

$$V_{\text{cell}} = hWL - \pi R_{\text{cell}}^2 \cdot L$$

$$= (3\text{cm})(3\text{cm})(3\text{cm}) - \pi(1\text{cm})^2(2\text{cm})$$

$$= 20.7 \text{ cm}^3$$

(again, ignore the R_{th} of the cell)

and for the cell:

$$C_{\text{th, cell}} = \rho_{\text{glass}} V_{\text{cell}} C_{p, \text{glass}}$$

$$= (2500 \frac{\text{kg}}{\text{m}^3})(1000 \frac{\text{cm}^3}{\text{m}^3})(\frac{1}{100^3} \frac{\text{m}^3}{\text{cm}^3})$$

$$\times (20.7 \text{ cm}^3)(0.5 \frac{\text{J}}{\text{g}\cdot\text{K}})$$

$\Rightarrow C_{\text{th, cell}} = \underline{\underline{25.9 \text{ J/K}}}$

Find $R_{\text{th, foot}}$:
 \Rightarrow foot dimensions:

$R_{\text{foot}} = 2\text{mm}$ $A_{\text{foot}} = \pi R_{\text{foot}}^2$
 $L_{\text{foot}} = 2\text{mm}$

EE C245: Introduction to MEMS Design
Lecture 3
C. Nguyen
9/4/08
34

Thermal Circuit Modeling

UC Berkeley

$$R_{th,foot} = \frac{l_{foot}}{k_{glass} \cdot A_{foot}} = \frac{2 \text{ mm}}{(1.05 \frac{\text{W}}{\text{m}\cdot\text{K}}) \pi (2 \text{ mm})^2}$$

$\Rightarrow R_{th,foot} = 151.6 \text{ k/W}$

Since there are 4 feet, the equivalent thermal ckt. becomes:

\Rightarrow find the time constant:

$$\tau = \left(\frac{R_{th,foot}}{4} \right) \cdot C_{th} = 16.4 \text{ min}$$

Time req'd to warm up & stabilize will be 3x this!
 \therefore must wait ~45 min. before using this clock!

Now, let's see what happens when we shrink the size of the atomic cell to MEMS-like dimensions ...

\Rightarrow find power req'd to maintain T_{oo} in steady state:

$$P = \frac{T_{oo} - T_o}{(R_{th,foot}/4)} = \frac{(80 - 25)}{9.48} = 1.45 \text{ W}$$

EE C245: Introduction to MEMS Design Lecture 3 C. Nguyen 9/4/08 35

MEMS Thermal Circuit Modeling

UC Berkeley

300x300x300 μm^3 } hollow w/
 Atomic Cell @ 80°C } 10 μm -thick walls
 (glass)

25°C

Heater
Laser

T Sensor (underneath)
Long, Thin Polysilicon Tethers

580 μm -long, 10 μm -thick, 20 μm -wide

$V_{cell} = (300 \mu)(300 \mu)(300 \mu) - (280 \mu)(280 \mu)(280 \mu)$
 $= 5.048 \times 10^{-12} \text{ m}^3$
 \hookrightarrow of course, much smaller than macro

$$C_{th,cell} = \rho_{glass} V_{cell} C_p, glass$$

$$= (2500 \frac{\text{kg}}{\text{m}^3}) (5.048 \times 10^{-12} \text{ m}^3) \times (500 \frac{\text{J}}{\text{kg}\cdot\text{K}})$$

$$\Rightarrow C_{th,cell} = 6.31 \times 10^{-6} \frac{\text{J}}{\text{K}}$$

\hookrightarrow 4 million x smaller than macro!

$$R_{th,supp} = \frac{l_{supp}}{k_{polys} \cdot w_{supp} \cdot h_{supp}}$$

$$= \frac{500 \mu}{(30 \frac{\text{W}}{\text{m}\cdot\text{K}}) (20 \mu) (10 \mu)} = 83,333 \text{ k/W}$$

\hookrightarrow 548x larger

and...

$$P = \frac{(80 - 25)}{83,333} = 2.64 \text{ mW} \leftarrow 548 \times \text{smaller!}$$

All due to scaling!

$$\tau = 0.13 \text{ s} \leftarrow 7300 \times \text{faster!}$$

EE C245: Introduction to MEMS Design Lecture 3 C. Nguyen 9/4/08 36



Micro Gas Analyzers (MGA)

EE_C245: Introduction to MEMS Design LecM 2 C. Nguyen 8/20/09 37



Micro Gas Analyzers

- **Objective:** enable remote detection of chemical agents via tiny, ultra-low power, fast, chip-scale gas analyzers that greatly reduce the incidence of false positives
- **Approach:** use micromachining technologies to implement separation-based analyzers (e.g., gas chromatographs, mass spectrometers) at the micro-scale to enhance gas selectivity

Conventional Sensor

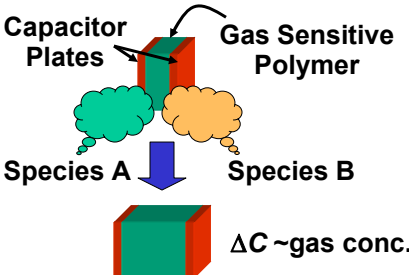

• **Problem:** polymer has finite sensitivity to both A & B

Separation Analyzer



• **Result:** species A & B now separated ⇒ can identify and analyze individually

EE_C245: Introduction to MEMS Design LecM 2 C. Nguyen 8/20/09 38

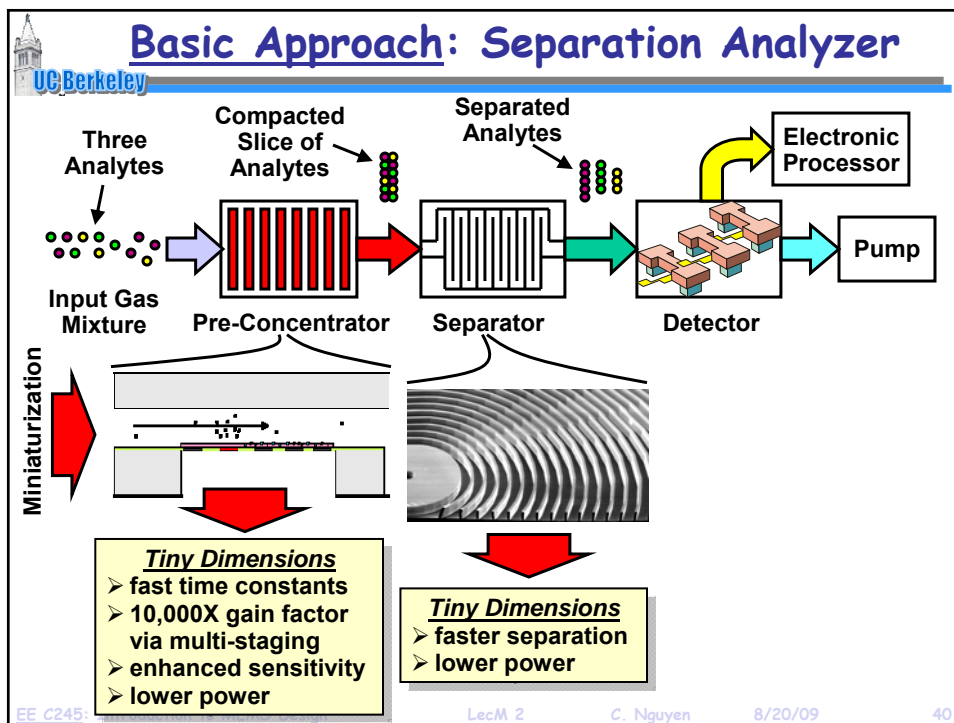
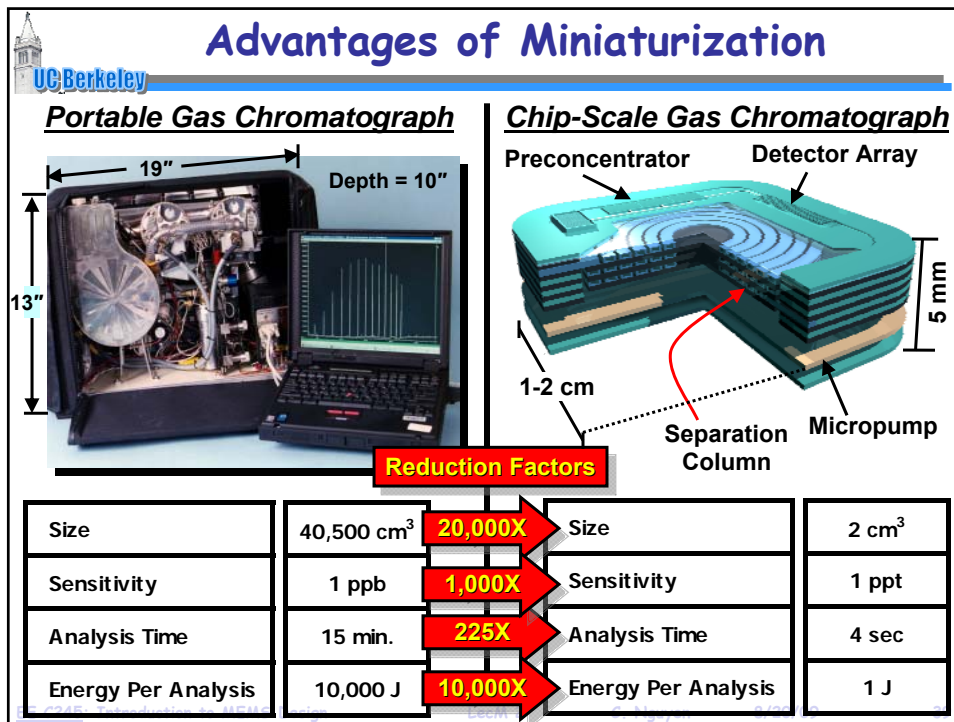

Scaling Leads to Faster Separation

- **Example:** gas chromatograph separation column
 - ↳ unique analyte interactions with the column walls
 - ↳ different analyte velocities
 - ↳ **result:** separation after a finite distance

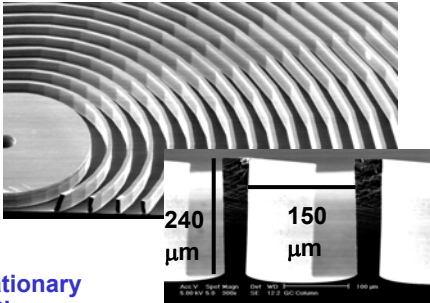

Wide Channel

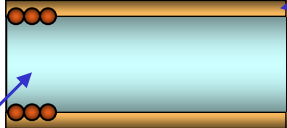

Carrier Gas (Mobile Phase)

Peak Broadens

➔

Thin Channel

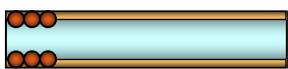

Less Separation Needed to Resolve

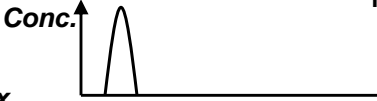
EE C245: Introduction to MEMS Design
LecM 2
C. Nguyen
8/20/09
41

Scaling Leads to Faster Separation

- **Example:** gas chromatograph separation column
 - ↳ unique analyte interactions with the column walls
 - ↳ different analyte velocities
 - ↳ **result:** separation after a finite distance

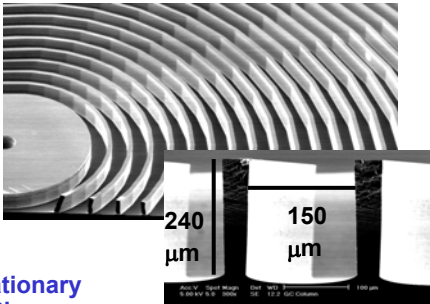

Wide Channel

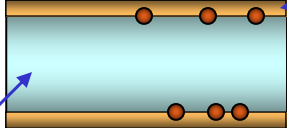

Carrier Gas (Mobile Phase)

➔

Thin Channel

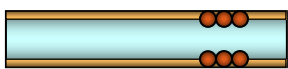

Column Width ↓ ➔ Surface-to-Volume Ratio ↑ ➔ Peak Spreading ↓ ➔ Separation Distance ↓

- **Result of Scaling:** shorter column length; faster analysis time

EE C245: Introduction to MEMS Design
LecM 2
C. Nguyen
8/20/09
42

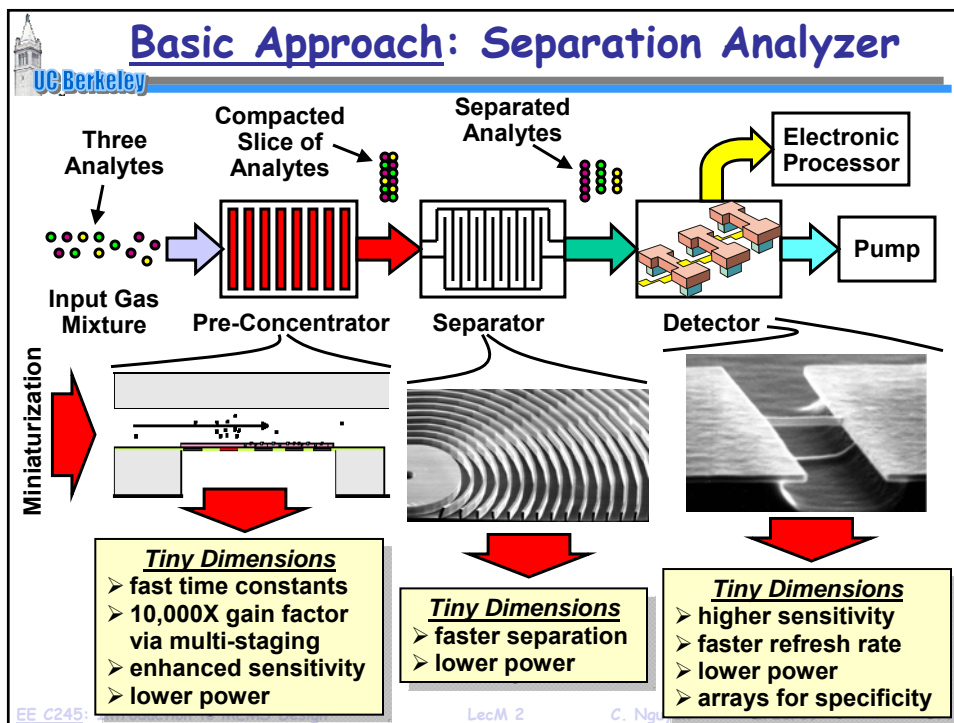
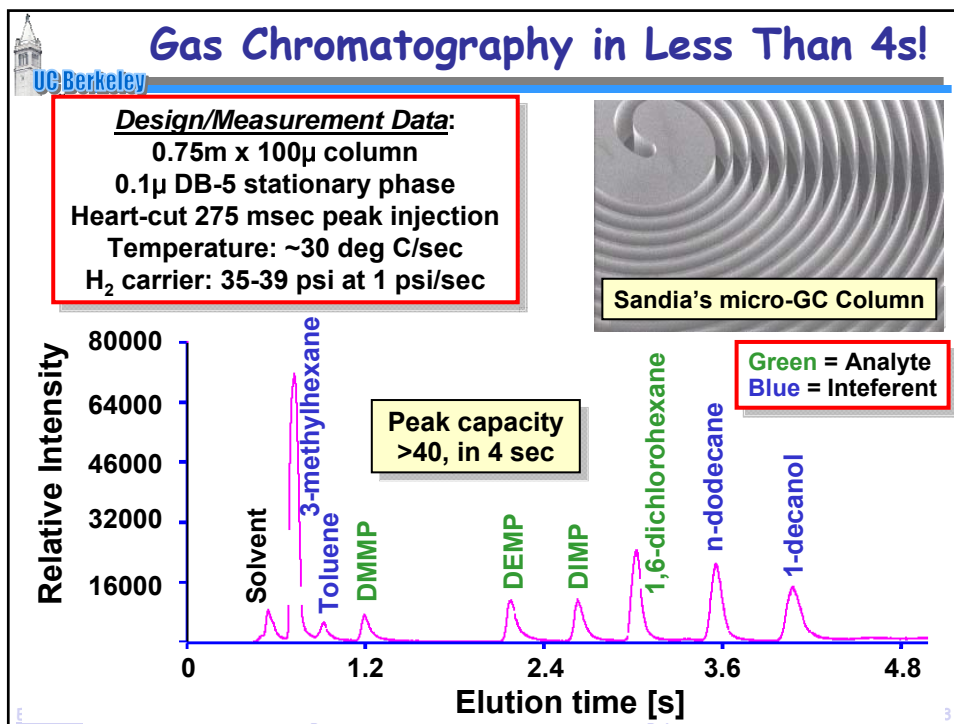

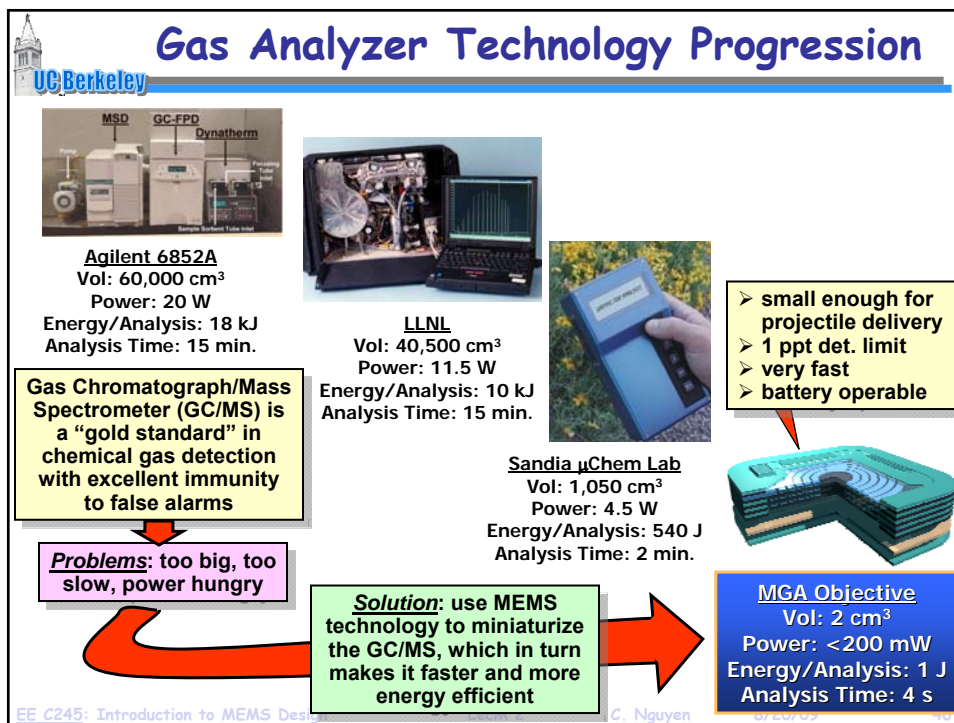
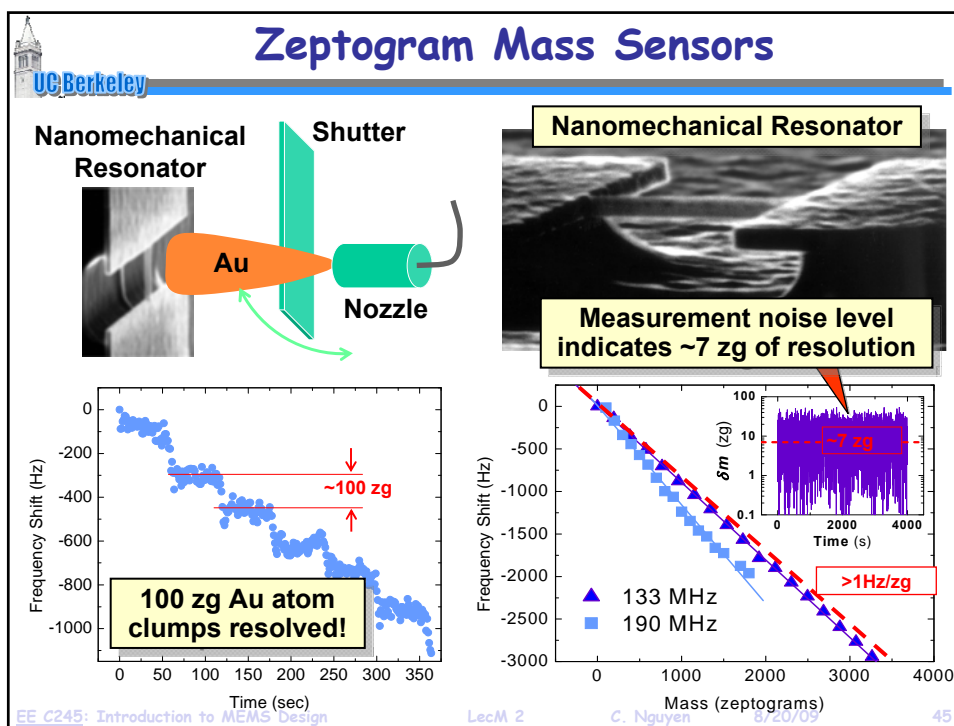

Example: Micromechanical Accelerometer

UC Berkeley

- The MEMS Advantage:**
 - >30X size reduction
 - accelerometer mechanism
 - allows integration with electronics

Tiny mass means small output \Rightarrow need integrated transistor circuits to compensate

Basic Operation Principle

$x \propto F_i = ma$

Labels in diagram: Displacement, Spring, Inertial Force, Proof Mass, Acceleration, x_0 , x .

400 μm

Analog Devices ADXL 78

EE C245: Introduction to MEMS Design LecM 2 C. Nguyen 8/20/09 47

Messages Going Forward ...

UC Berkeley

- MEMS are micro-scale or smaller devices/systems that operate mainly via a mechanical or electromechanical means
- MEMS \Rightarrow NEMS offer the same scaling advantages that IC technology offers (e.g., speed, low power, complexity, cost), but they do so for domains beyond electronics:

Size \downarrow

- resonant frequency \uparrow (faster speed)
- actuation force \downarrow (lower power)
- # mechanical elements \uparrow (higher complexity)
- integration level \uparrow (lower cost)

- Micro ... nano ... *it's all good*
- Just as important: MEMS or NEMS have brought together people from diverse disciplines \Rightarrow this is the key to growth!
- What's next? \Rightarrow Nano-nuclear fusion? Chip-scale atomic sensors?

... limitless possibilities ...

EE C245: Introduction to MEMS Design LecM 2 C. Nguyen 8/20/09 48