

61A Lecture 37

Announcements

Ambiguity

Syntactic Ambiguity in English

Programs must be written for people to read

Syntactic Ambiguity in English

Programs must be written for people to read¹

¹Preface of **Structure and Interpretation of Computer Programs**
by Harold Abelson and Gerald Sussman with Julie Sussman

Syntactic Ambiguity in English

|----- Sentence -----|

Programs must be written for people to read¹

¹Preface of **Structure and Interpretation of Computer Programs**
by Harold Abelson and Gerald Sussman with Julie Sussman

Syntactic Ambiguity in English

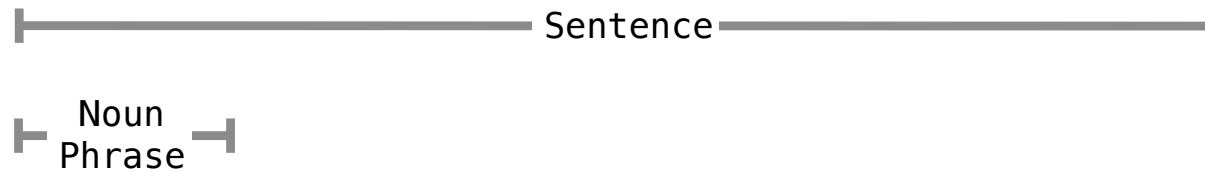

Programs must be written for people to read¹

¹Preface of **Structure and Interpretation of Computer Programs**
by Harold Abelson and Gerald Sussman with Julie Sussman

Syntactic Ambiguity in English

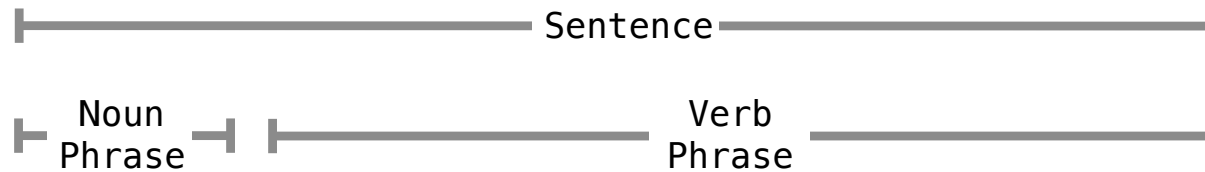

Programs must be written for people to read¹

¹Preface of **Structure and Interpretation of Computer Programs**
by Harold Abelson and Gerald Sussman with Julie Sussman

Syntactic Ambiguity in English

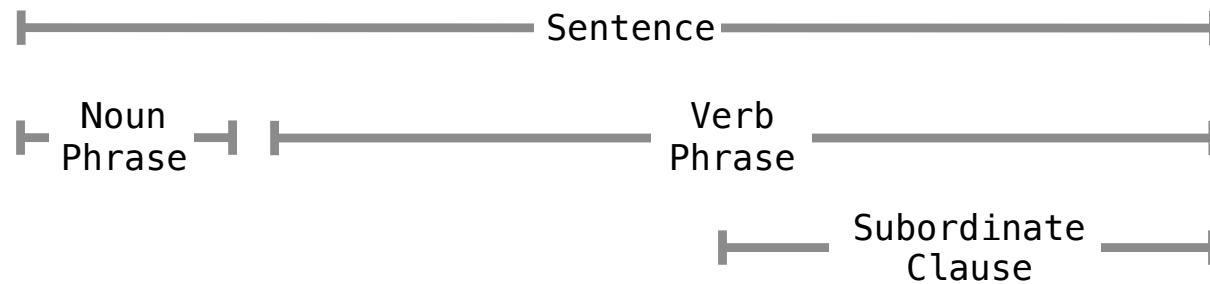

Programs must be written for people to read¹

¹Preface of **Structure and Interpretation of Computer Programs**
by Harold Abelson and Gerald Sussman with Julie Sussman

Syntactic Ambiguity in English

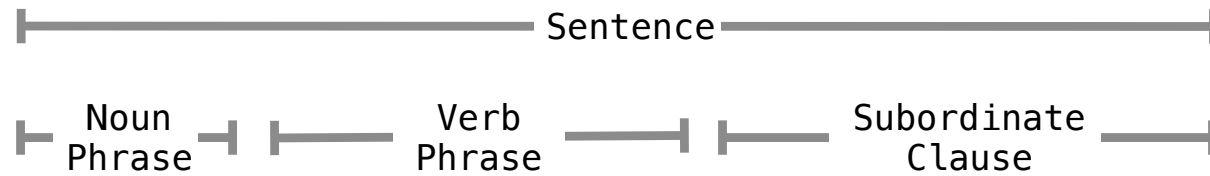

Programs must be written for people to read¹

¹Preface of **Structure and Interpretation of Computer Programs**
by Harold Abelson and Gerald Sussman with Julie Sussman

Syntactic Ambiguity in English

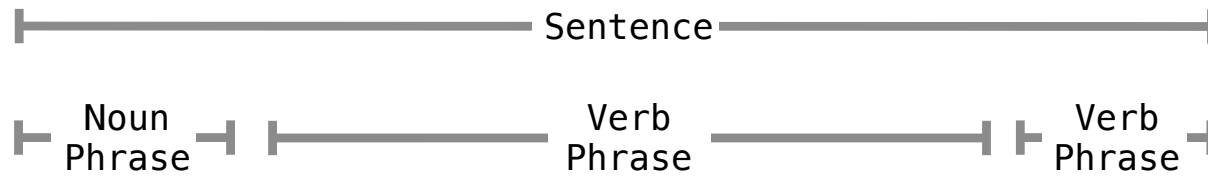

Programs must be written for people to read¹

¹Preface of **Structure and Interpretation of Computer Programs**
by Harold Abelson and Gerald Sussman with Julie Sussman

Syntactic Ambiguity in English

pro•gram (noun)

a series of coded software instructions

pro•gram (verb)

provide a computer with coded instructions

Programs must be written for people to read

must (verb)

be obliged to

must (noun)

dampness or mold

Syntax Trees

Representing Syntactic Structure

Representing Syntactic Structure

COWS

Representing Syntactic Structure

Noun

COWS

Representing Syntactic Structure



Photo by Vince O'Sullivan licensed under <http://creativecommons.org/licenses/by-nc-nd/2.0/>

Noun

COWS

Representing Syntactic Structure



Photo by Vince O'Sullivan licensed under <http://creativecommons.org/licenses/by-nc-nd/2.0/>

Noun

cows

intimidate

Representing Syntactic Structure



Photo by Vince O'Sullivan licensed under <http://creativecommons.org/licenses/by-nc-nd/2.0/>

Noun

cows

Verb

intimidate

Representing Syntactic Structure



Photo by Vince O'Sullivan licensed under <http://creativecommons.org/licenses/by-nc-nd/2.0/>

Noun

cows

Verb

intimidate

Noun

cows

Representing Syntactic Structure



Photo by Vince O'Sullivan licensed under <http://creativecommons.org/licenses/by-nc-nd/2.0/>

|----- Sentence -----|

Noun

cows

Verb

intimidate

Noun

cows

Representing Syntactic Structure



Photo by Vince O'Sullivan licensed under <http://creativecommons.org/licenses/by-nc-nd/2.0/>

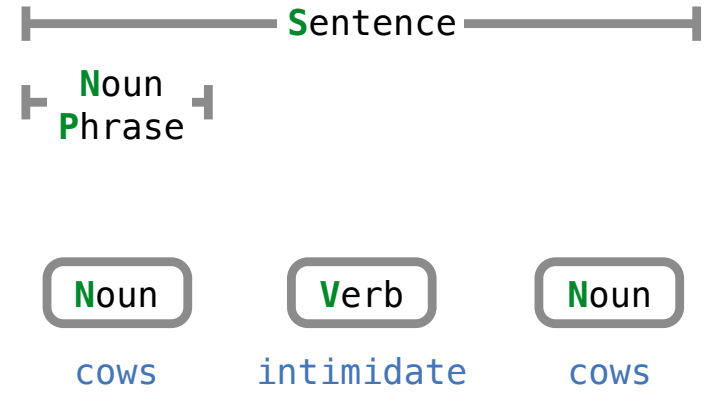

Representing Syntactic Structure



Photo by Vince O'Sullivan licensed under <http://creativecommons.org/licenses/by-nc-nd/2.0/>

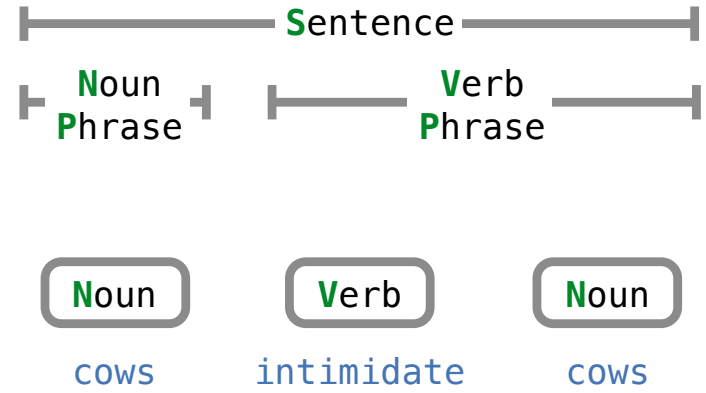

Representing Syntactic Structure



Photo by Vince O'Sullivan licensed under <http://creativecommons.org/licenses/by-nc-nd/2.0/>

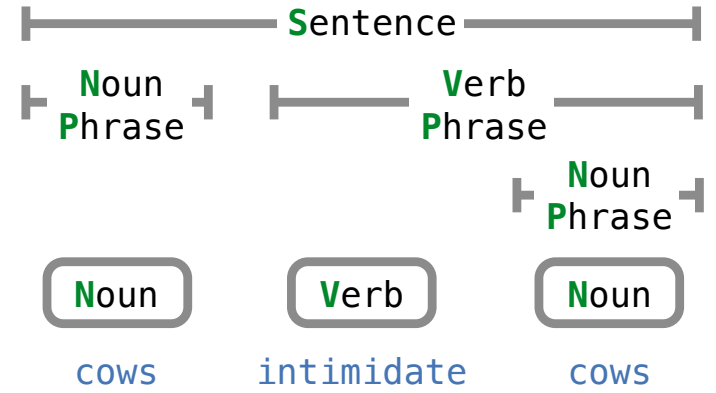

Representing Syntactic Structure



Photo by Vince O'Sullivan licensed under <http://creativecommons.org/licenses/by-nc-nd/2.0/>

A **Tree** represents a phrase:

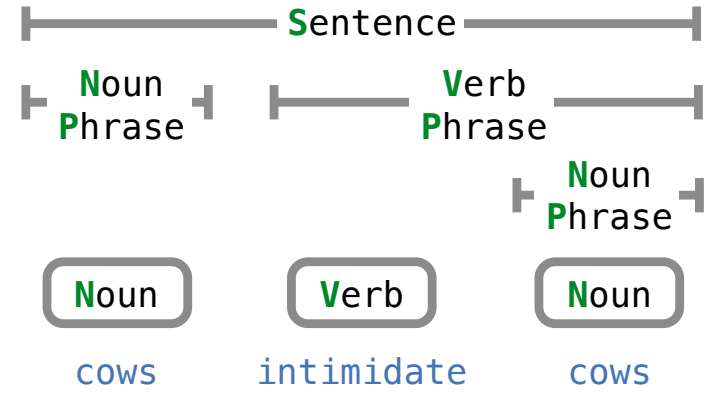

Representing Syntactic Structure



Photo by Vince O'Sullivan licensed under <http://creativecommons.org/licenses/by-nc-nd/2.0/>

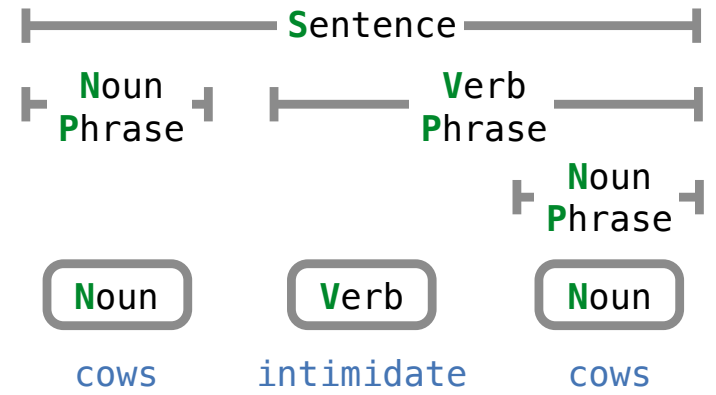

A **Tree** represents a phrase:

- **tag** -- What kind of phrase (e.g., **S**, **NP**, **VP**)

Representing Syntactic Structure



Photo by Vince O'Sullivan licensed under <http://creativecommons.org/licenses/by-nc-nd/2.0/>

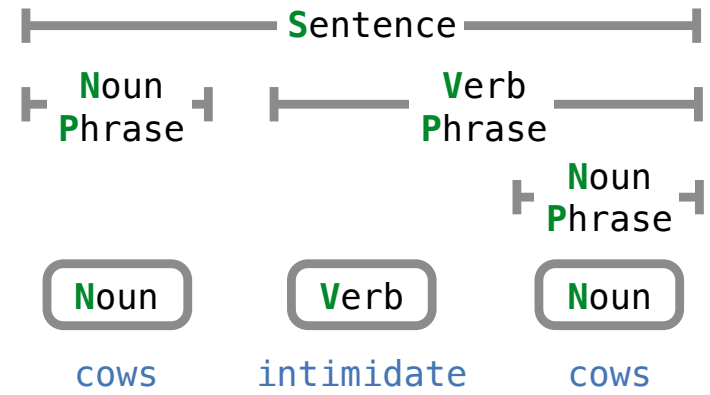

A **Tree** represents a phrase:

- **tag** — What kind of phrase (e.g., **S**, **NP**, **VP**)
- **branches** — Sequence of **Tree** or **Leaf** components

Representing Syntactic Structure



Photo by Vince O'Sullivan licensed under <http://creativecommons.org/licenses/by-nc-nd/2.0/>

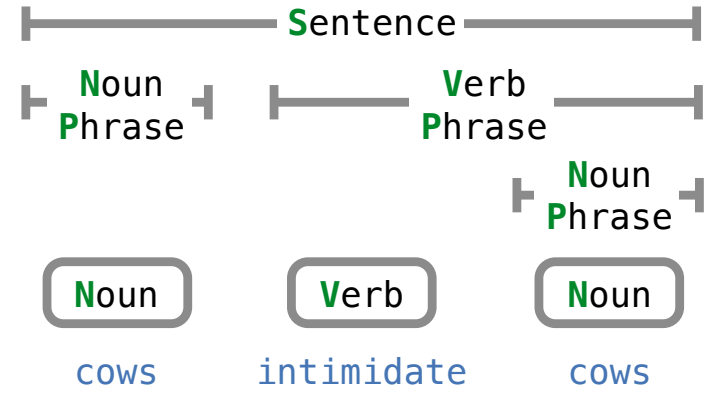

A **Tree** represents a phrase:

- **tag** — What kind of phrase (e.g., **S**, **NP**, **VP**)
- **branches** — Sequence of **Tree** or **Leaf** components

A **Leaf** represents a single word:

Representing Syntactic Structure



Photo by Vince O'Sullivan licensed under <http://creativecommons.org/licenses/by-nc-nd/2.0/>

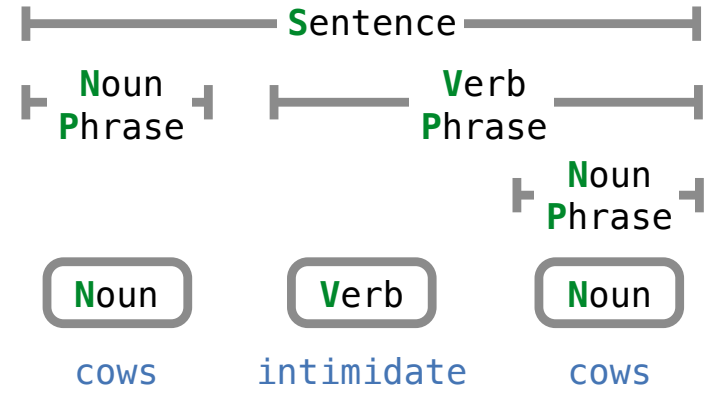

A **Tree** represents a phrase:

- **tag** -- What kind of phrase (e.g., **S**, **NP**, **VP**)
- **branches** -- Sequence of **Tree** or **Leaf** components

A **Leaf** represents a single word:

- **tag** -- What kind of word (e.g., **N**, **V**)

Representing Syntactic Structure



Photo by Vince O'Sullivan licensed under <http://creativecommons.org/licenses/by-nc-nd/2.0/>

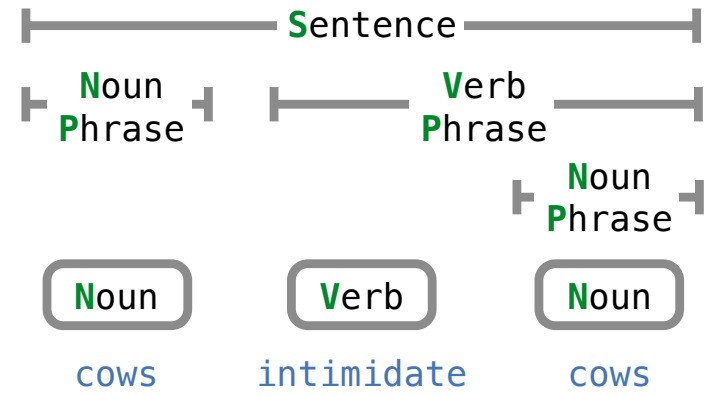

A **Tree** represents a phrase:

- **tag** -- What kind of phrase (e.g., **S**, **NP**, **VP**)
- **branches** -- Sequence of **Tree** or **Leaf** components

A **Leaf** represents a single word:

- **tag** -- What kind of word (e.g., **N**, **V**)
- **word** -- The word

Representing Syntactic Structure



Photo by Vince O'Sullivan licensed under <http://creativecommons.org/licenses/by-nc-nd/2.0/>

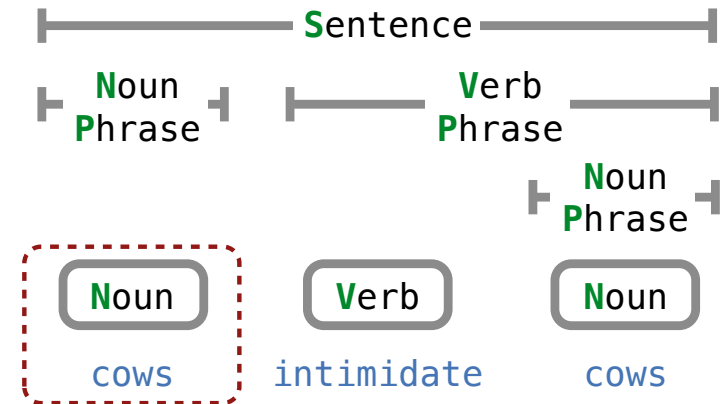

A **Tree** represents a phrase:

- **tag** -- What kind of phrase (e.g., **S**, **NP**, **VP**)
- **branches** -- Sequence of **Tree** or **Leaf** components

A **Leaf** represents a single word:

- **tag** -- What kind of word (e.g., **N**, **V**)
- **word** -- The word

Representing Syntactic Structure



Photo by Vince O'Sullivan licensed under <http://creativecommons.org/licenses/by-nc-nd/2.0/>

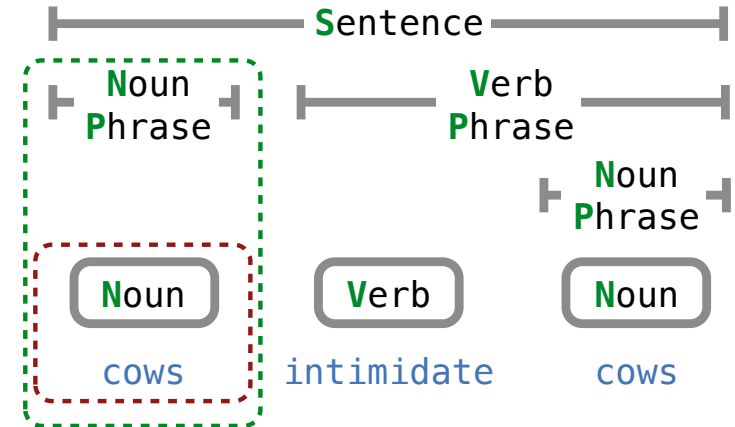

A **Tree** represents a phrase:

- **tag** -- What kind of phrase (e.g., **S**, **NP**, **VP**)
- **branches** -- Sequence of **Tree** or **Leaf** components

A **Leaf** represents a single word:

- **tag** -- What kind of word (e.g., **N**, **V**)
- **word** -- The word

Representing Syntactic Structure



Photo by Vince O'Sullivan licensed under <http://creativecommons.org/licenses/by-nc-nd/2.0/>

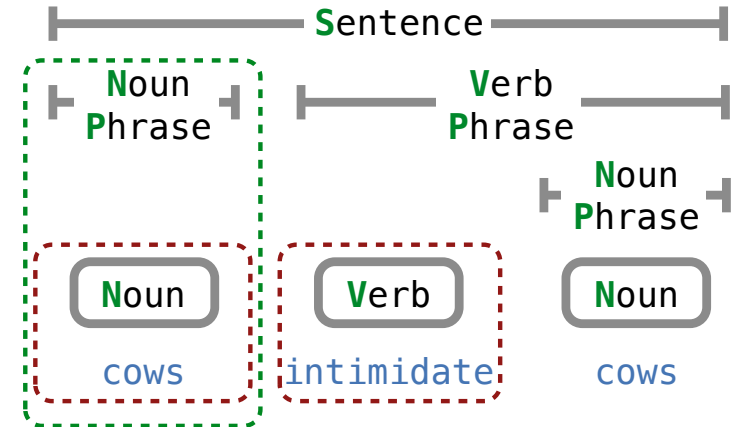

A **Tree** represents a phrase:

- **tag** -- What kind of phrase (e.g., **S**, **NP**, **VP**)
- **branches** -- Sequence of **Tree** or **Leaf** components

A **Leaf** represents a single word:

- **tag** -- What kind of word (e.g., **N**, **V**)
- **word** -- The word

Representing Syntactic Structure



Photo by Vince O'Sullivan licensed under <http://creativecommons.org/licenses/by-nc-nd/2.0/>

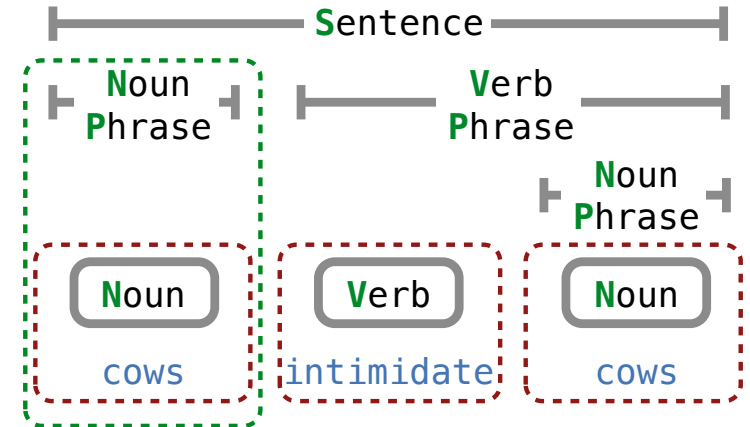

A **Tree** represents a phrase:

- **tag** -- What kind of phrase (e.g., **S**, **NP**, **VP**)
- **branches** -- Sequence of **Tree** or **Leaf** components

A **Leaf** represents a single word:

- **tag** -- What kind of word (e.g., **N**, **V**)
- **word** -- The word

Representing Syntactic Structure



Photo by Vince O'Sullivan licensed under <http://creativecommons.org/licenses/by-nc-nd/2.0/>

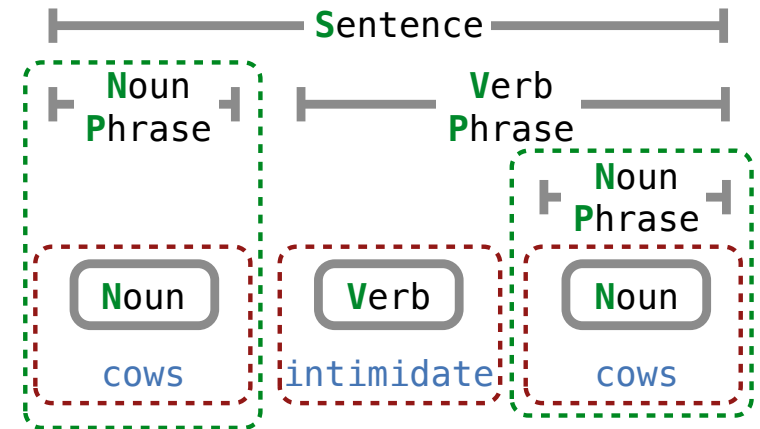

A **Tree** represents a phrase:

- **tag** -- What kind of phrase (e.g., **S**, **NP**, **VP**)
- **branches** -- Sequence of **Tree** or **Leaf** components

A **Leaf** represents a single word:

- **tag** -- What kind of word (e.g., **N**, **V**)
- **word** -- The word

Representing Syntactic Structure



Photo by Vince O'Sullivan licensed under <http://creativecommons.org/licenses/by-nc-nd/2.0/>

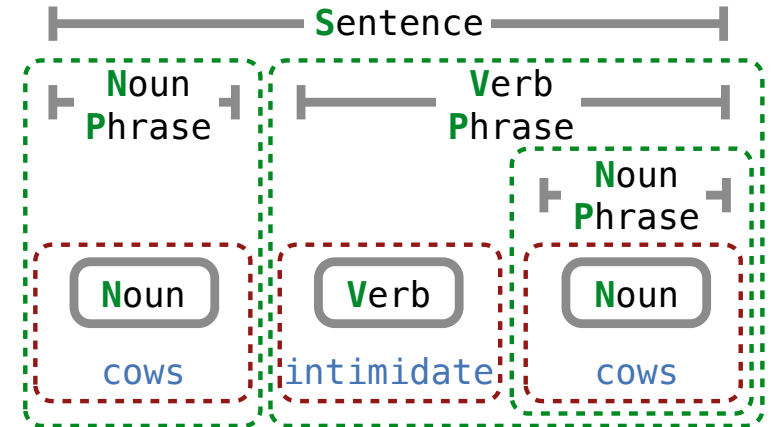

A **Tree** represents a phrase:

- **tag** -- What kind of phrase (e.g., **S**, **NP**, **VP**)
- **branches** -- Sequence of **Tree** or **Leaf** components

A **Leaf** represents a single word:

- **tag** -- What kind of word (e.g., **N**, **V**)
- **word** -- The word

Representing Syntactic Structure



Photo by Vince O'Sullivan licensed under <http://creativecommons.org/licenses/by-nc-nd/2.0/>

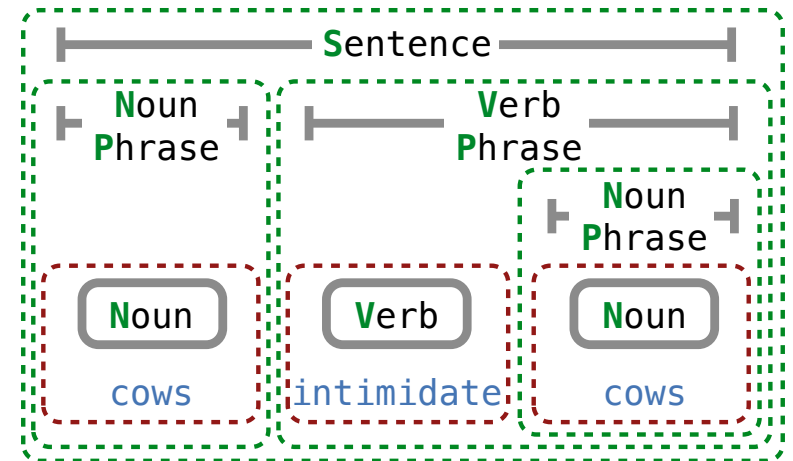

A **Tree** represents a phrase:

- **tag** -- What kind of phrase (e.g., **S**, **NP**, **VP**)
- **branches** -- Sequence of **Tree** or **Leaf** components

A **Leaf** represents a single word:

- **tag** -- What kind of word (e.g., **N**, **V**)
- **word** -- The word

Representing Syntactic Structure



Photo by Vince O'Sullivan licensed under <http://creativecommons.org/licenses/by-nc-nd/2.0/>

A **Tree** represents a phrase:

- **tag** -- What kind of phrase (e.g., **S**, **NP**, **VP**)
- **branches** -- Sequence of **Tree** or **Leaf** components

A **Leaf** represents a single word:

- **tag** -- What kind of word (e.g., **N**, **V**)
- **word** -- The word

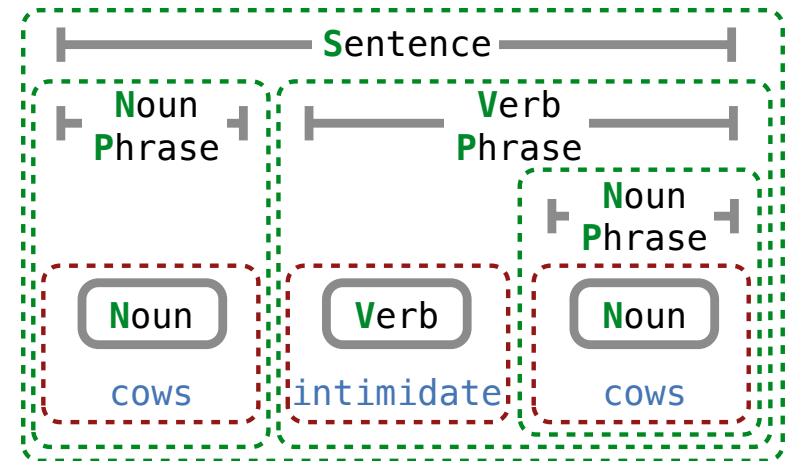

cows = **Leaf**('N', 'cows')

Representing Syntactic Structure

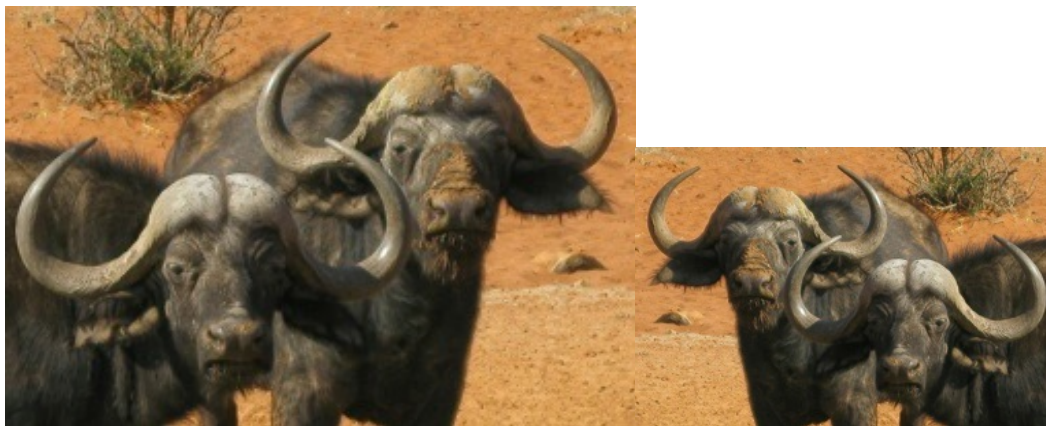

Photo by Vince O'Sullivan licensed under <http://creativecommons.org/licenses/by-nc-nd/2.0/>

A **Tree** represents a phrase:

- **tag** -- What kind of phrase (e.g., **S**, **NP**, **VP**)
- **branches** -- Sequence of **Tree** or **Leaf** components

A **Leaf** represents a single word:

- **tag** -- What kind of word (e.g., **N**, **V**)
- **word** -- The word

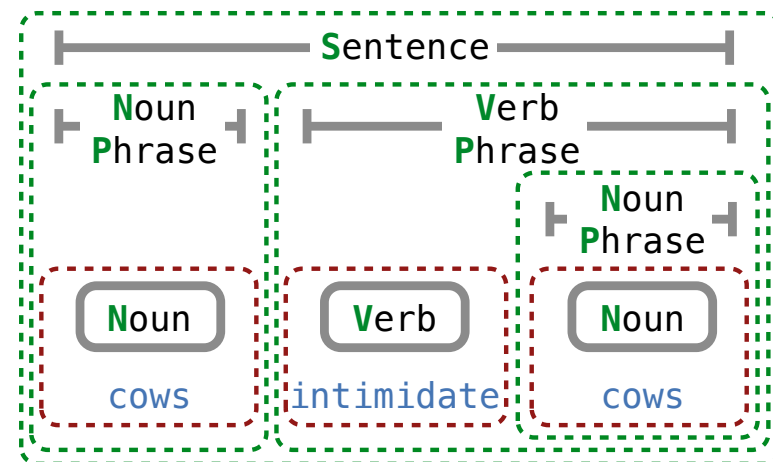

cows = **Leaf**('N', 'cows')

intimidate = **Leaf**('V', 'intimidate')

Representing Syntactic Structure

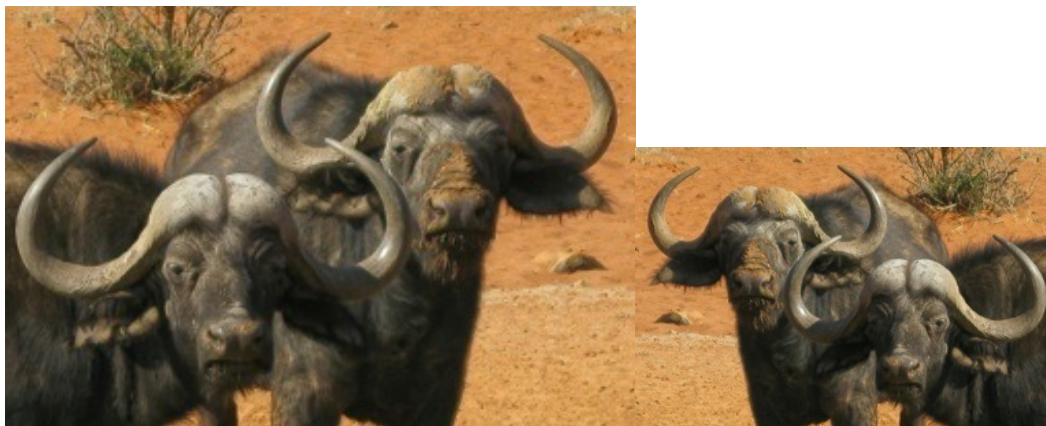

Photo by Vince O'Sullivan licensed under <http://creativecommons.org/licenses/by-nc-nd/2.0/>

A **Tree** represents a phrase:

- **tag** -- What kind of phrase (e.g., **S**, **NP**, **VP**)
- **branches** -- Sequence of **Tree** or **Leaf** components

A **Leaf** represents a single word:

- **tag** -- What kind of word (e.g., **N**, **V**)
- **word** -- The word

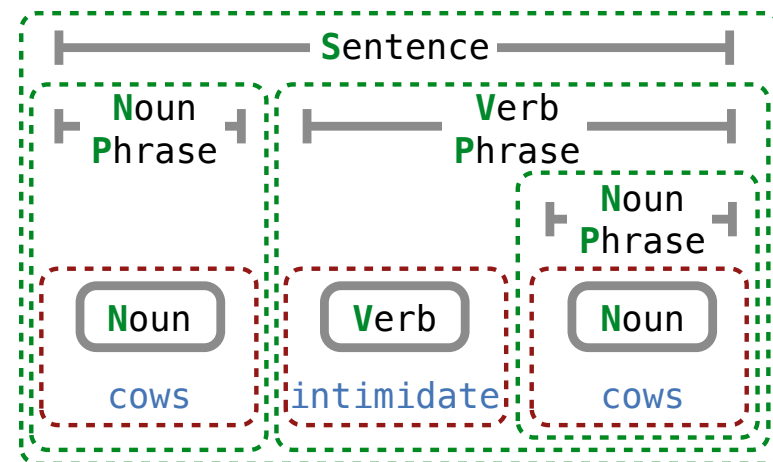

cows = **Leaf**('N', 'cows')

intimidate = **Leaf**('V', 'intimidate')

S, **NP**, **VP** = 'S', 'NP', 'VP'

Representing Syntactic Structure



Photo by Vince O'Sullivan licensed under <http://creativecommons.org/licenses/by-nc-nd/2.0/>

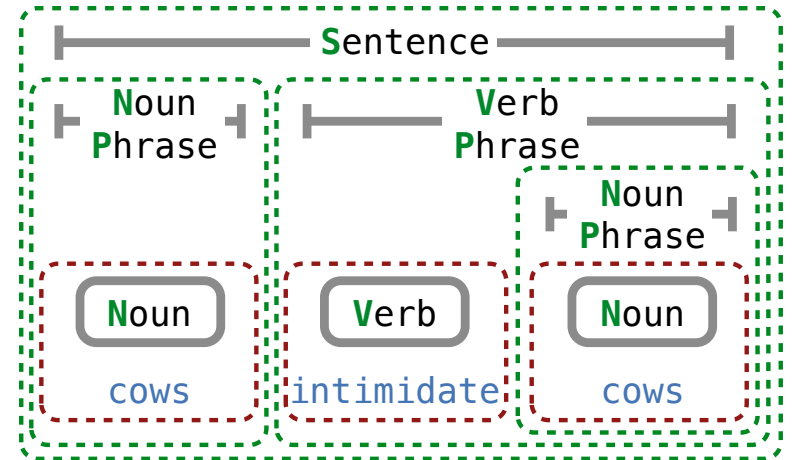

A **Tree** represents a phrase:

- **tag** -- What kind of phrase (e.g., **S**, **NP**, **VP**)
- **branches** -- Sequence of **Tree** or **Leaf** components

A **Leaf** represents a single word:

- **tag** -- What kind of word (e.g., **N**, **V**)
- **word** -- The word

cows = **Leaf**('N', 'cows')

intimidate = **Leaf**('V', 'intimidate')

S, **NP**, **VP** = 'S', 'NP', 'VP'

Tree(**S**, [**Tree**(**NP**, [**cows**]),

Representing Syntactic Structure



Photo by Vince O'Sullivan licensed under <http://creativecommons.org/licenses/by-nc-nd/2.0/>

A **Tree** represents a phrase:

- **tag** -- What kind of phrase (e.g., **S**, **NP**, **VP**)
- **branches** -- Sequence of **Tree** or **Leaf** components

A **Leaf** represents a single word:

- **tag** -- What kind of word (e.g., **N**, **V**)
- **word** -- The word

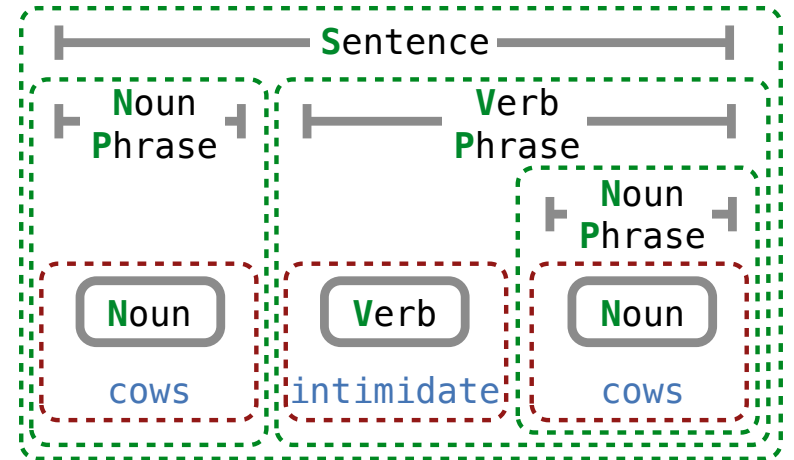

cows = **Leaf**('N', 'cows')

intimidate = **Leaf**('V', 'intimidate')

S, **NP**, **VP** = 'S', 'NP', 'VP'

Tree(**S**, [**Tree**(**NP**, [**cows**]),

Tree(**VP**, [**intimidate**,

Representing Syntactic Structure



Photo by Vince O'Sullivan licensed under <http://creativecommons.org/licenses/by-nc-nd/2.0/>

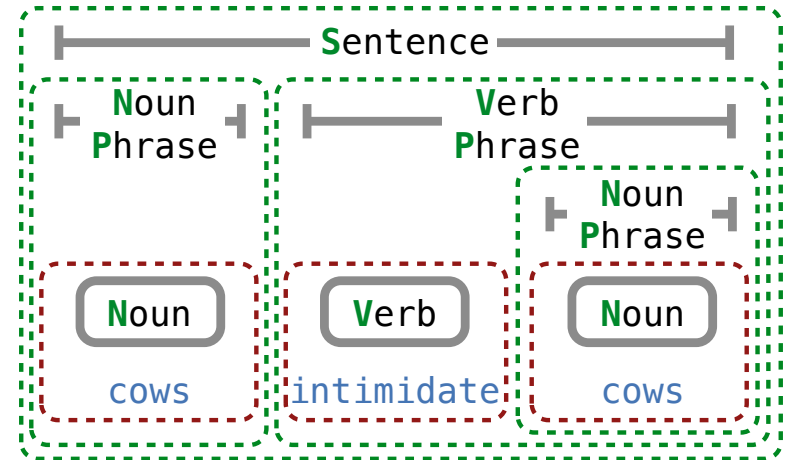

A **Tree** represents a phrase:

- **tag** -- What kind of phrase (e.g., **S**, **NP**, **VP**)
- **branches** -- Sequence of **Tree** or **Leaf** components

A **Leaf** represents a single word:

- **tag** -- What kind of word (e.g., **N**, **V**)
- **word** -- The word

```
cows = Leaf('N', 'cows')
```

```
intimidate = Leaf('V', 'intimidate')
```

```
S, NP, VP = 'S', 'NP', 'VP'
```

```
Tree(S, [Tree(NP, [cows]),
```

```
Tree(VP, [intimidate,
```

```
Tree(NP, [cows])])])])
```

Representing Syntactic Structure



Photo by Vince O'Sullivan licensed under <http://creativecommons.org/licenses/by-nc-nd/2.0/>

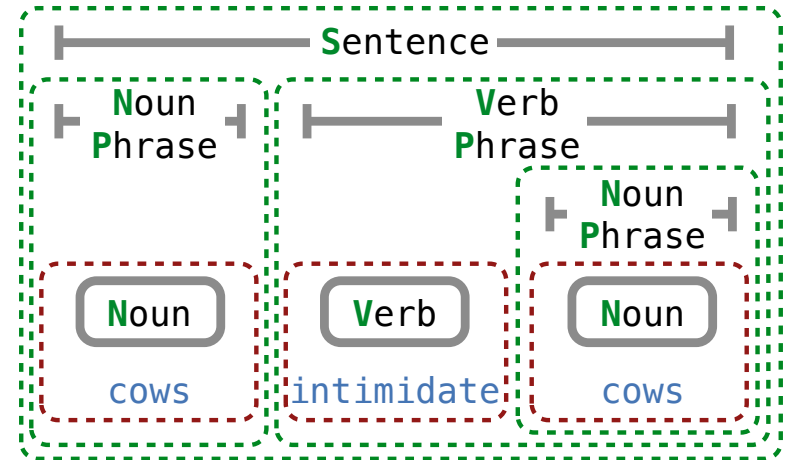

A **Tree** represents a phrase:

- **tag** -- What kind of phrase (e.g., **S**, **NP**, **VP**)
- **branches** -- Sequence of **Tree** or **Leaf** components

A **Leaf** represents a single word:

- **tag** -- What kind of word (e.g., **N**, **V**)
- **word** -- The word

```
cows = Leaf('N', 'cows')
```

```
intimidate = Leaf('V', 'intimidate')
```

```
S, NP, VP = 'S', 'NP', 'VP'
```

```
Tree(S, [Tree(NP, [cows]),  
         Tree(VP, [intimidate,  
                   Tree(NP, [cows])])])])
```

(Demo)

Grammars

Context-Free Grammar Rules

Context-Free Grammar Rules

A grammar rule describes how a tag can be expanded as a sequence of tags or words

Context-Free Grammar Rules

A grammar rule describes how a tag can be expanded as a sequence of tags or words

S → **NP VP**

Context-Free Grammar Rules

A grammar rule describes how a tag can be expanded as a sequence of tags or words



Context-Free Grammar Rules

A grammar rule describes how a tag can be expanded as a sequence of tags or words



Context-Free Grammar Rules

A grammar rule describes how a tag can be expanded as a sequence of tags or words

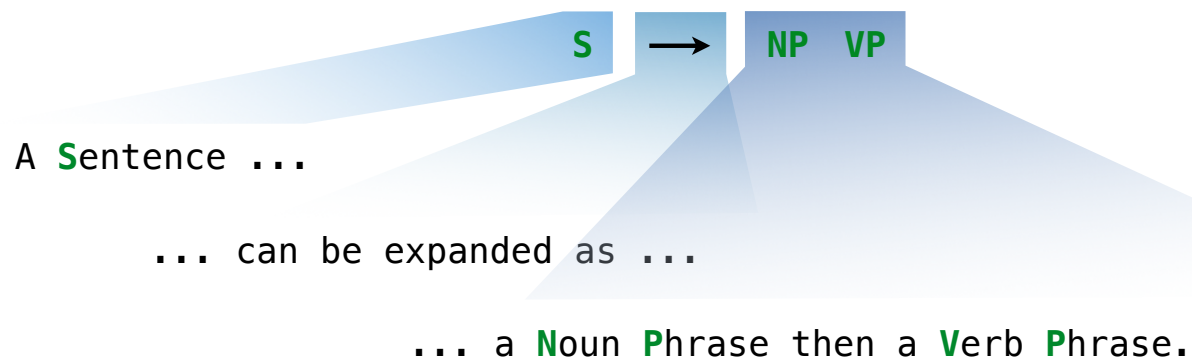

Context-Free Grammar Rules

A grammar rule describes how a tag can be expanded as a sequence of tags or words

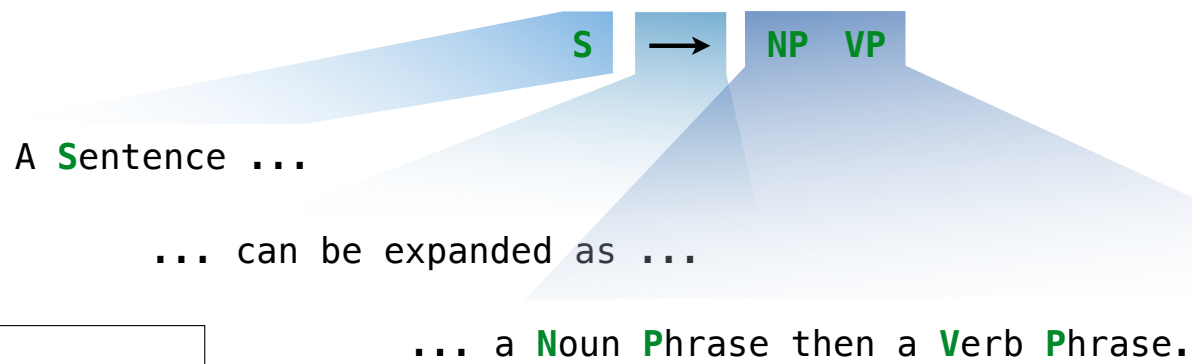

Grammar

Context-Free Grammar Rules

A grammar rule describes how a tag can be expanded as a sequence of tags or words

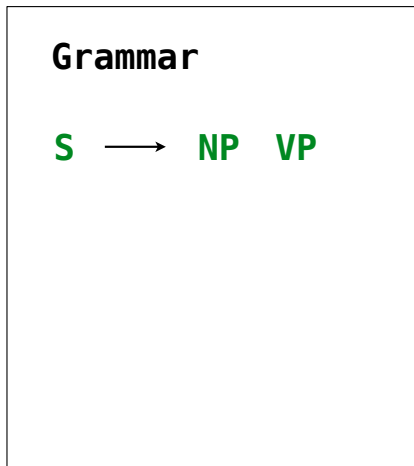
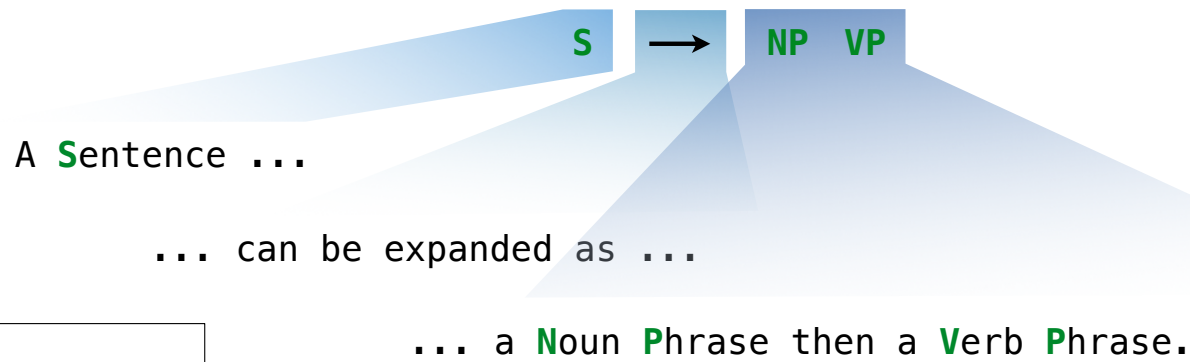

Context-Free Grammar Rules

A grammar rule describes how a tag can be expanded as a sequence of tags or words

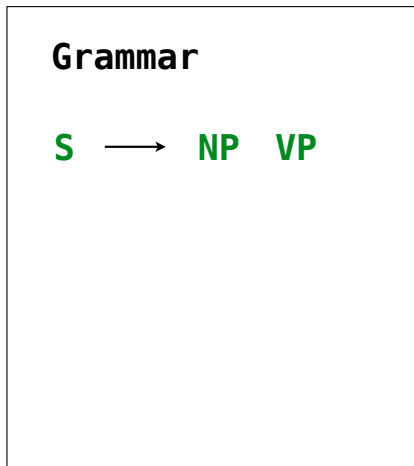
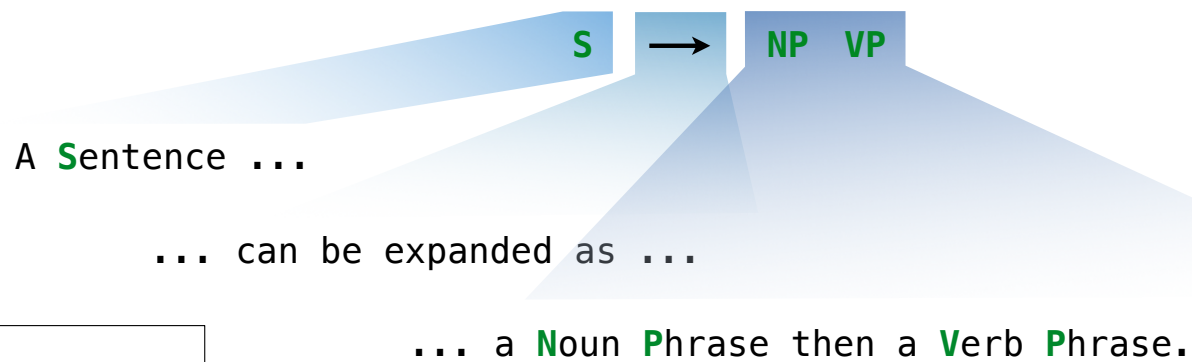

Context-Free Grammar Rules

A grammar rule describes how a tag can be expanded as a sequence of tags or words

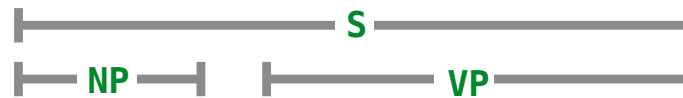
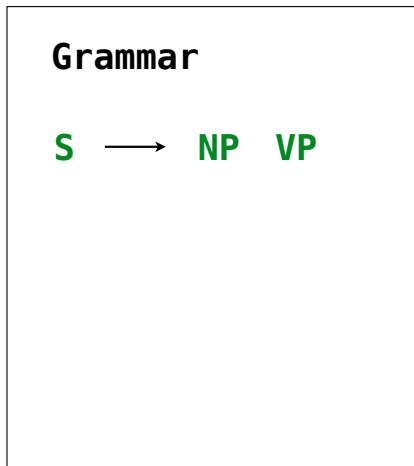
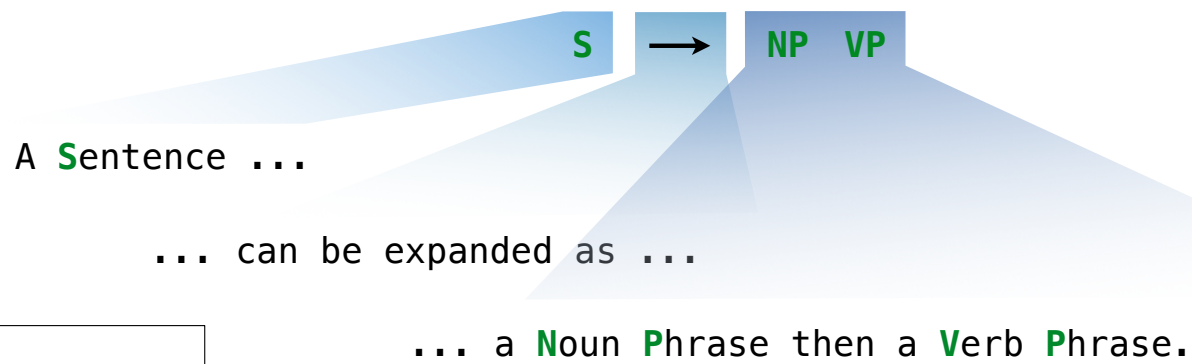

Context-Free Grammar Rules

A grammar rule describes how a tag can be expanded as a sequence of tags or words

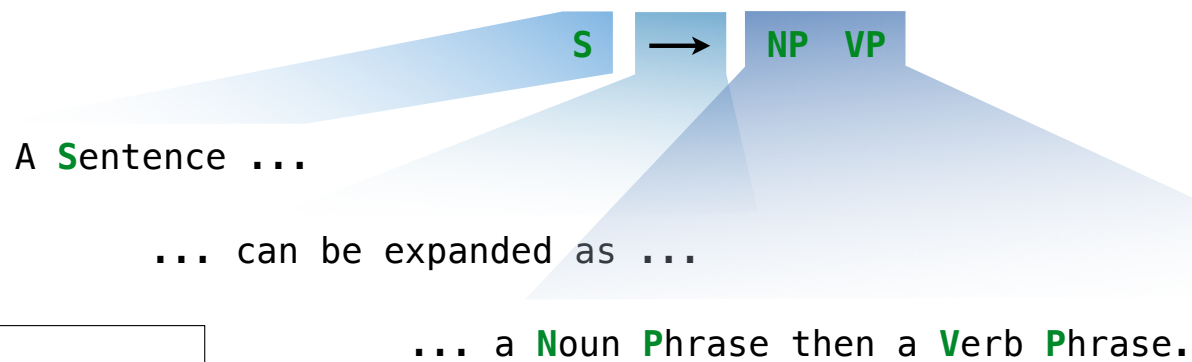

Grammar

S → **NP** **VP**

NP → **N**

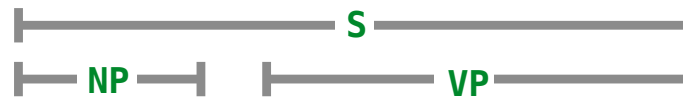

Context-Free Grammar Rules

A grammar rule describes how a tag can be expanded as a sequence of tags or words

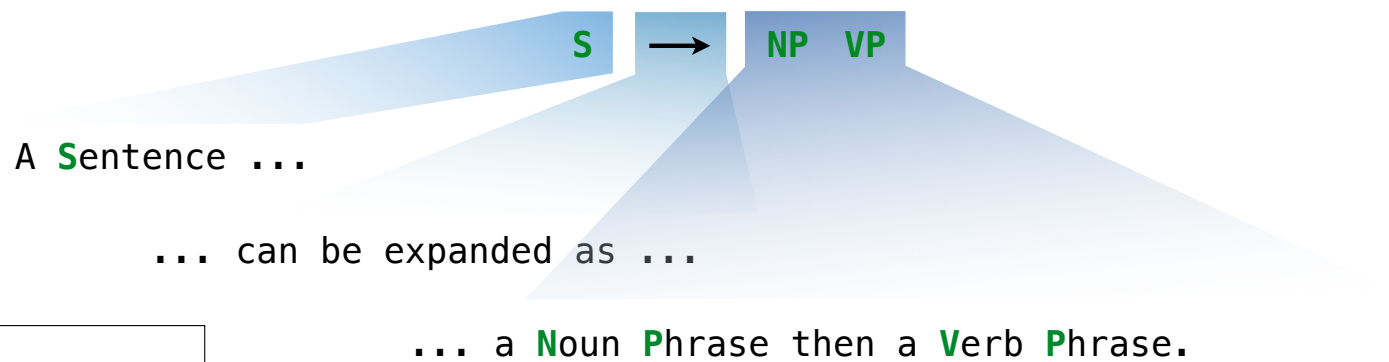

Grammar

S → **NP** **VP**

NP → **N**

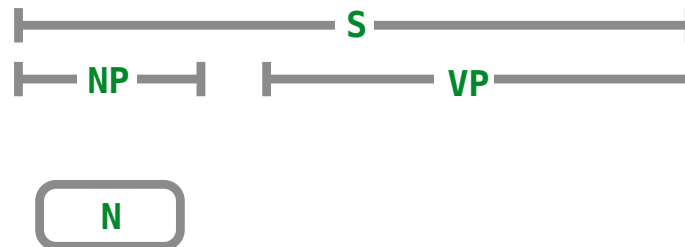

Context-Free Grammar Rules

A grammar rule describes how a tag can be expanded as a sequence of tags or words

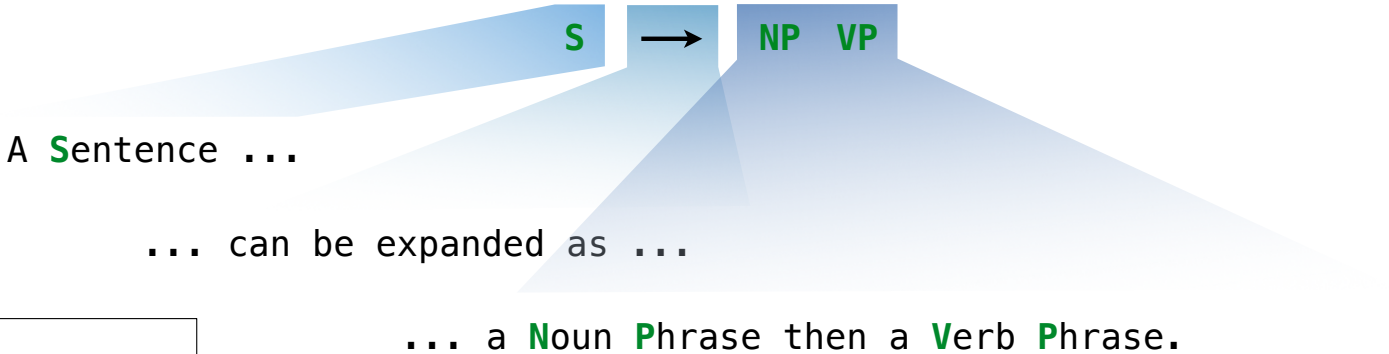

Grammar

- S → NP VP
- NP → N
- N → COWS

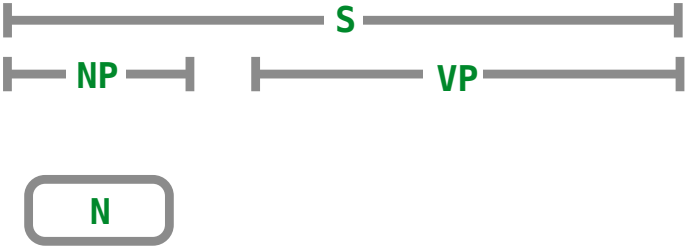

Context-Free Grammar Rules

A grammar rule describes how a tag can be expanded as a sequence of tags or words

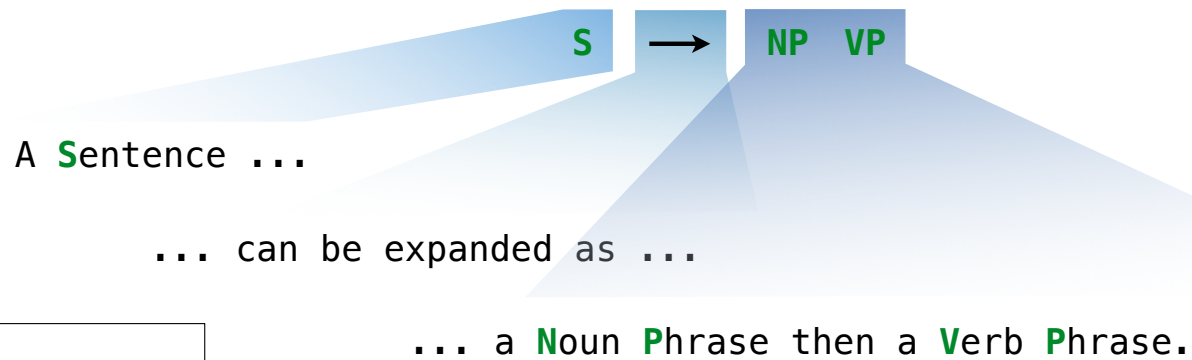

Grammar	
S	→ NP VP
NP	→ N
N	→ COWS

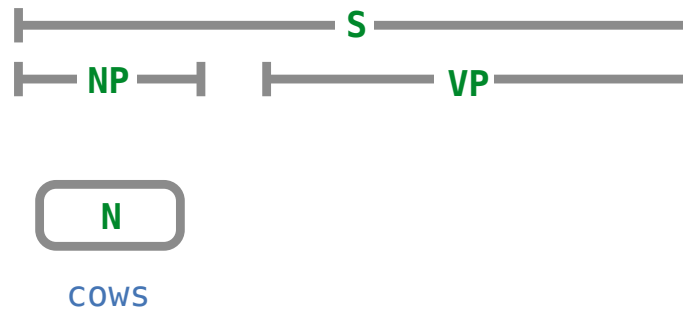

Context-Free Grammar Rules

A grammar rule describes how a tag can be expanded as a sequence of tags or words

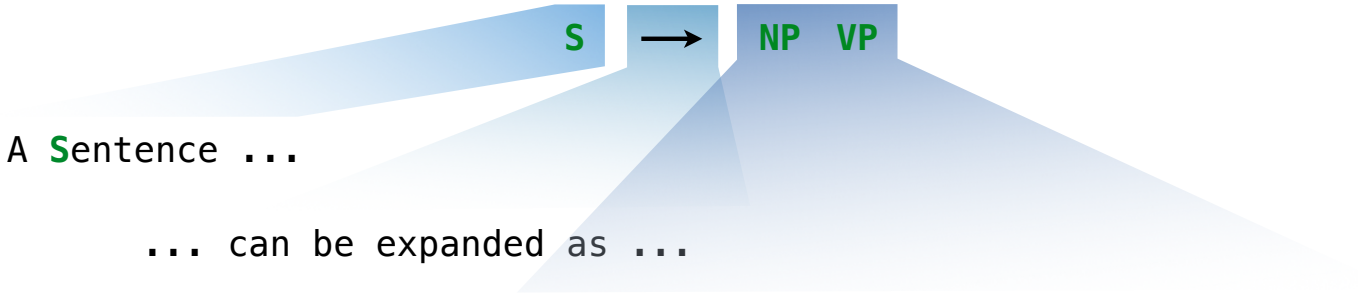

... a Noun Phrase then a Verb Phrase.

Grammar

- S → NP VP
- NP → N
- N → COWS

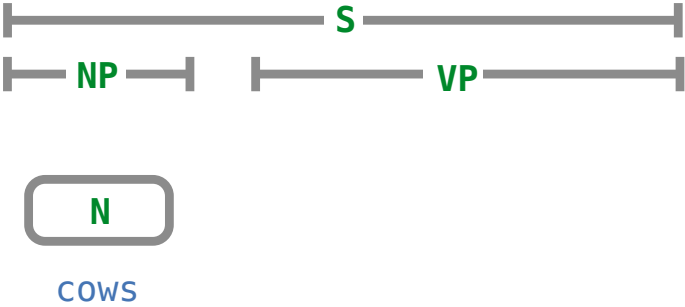

Context-Free Grammar Rules

A grammar rule describes how a tag can be expanded as a sequence of tags or words

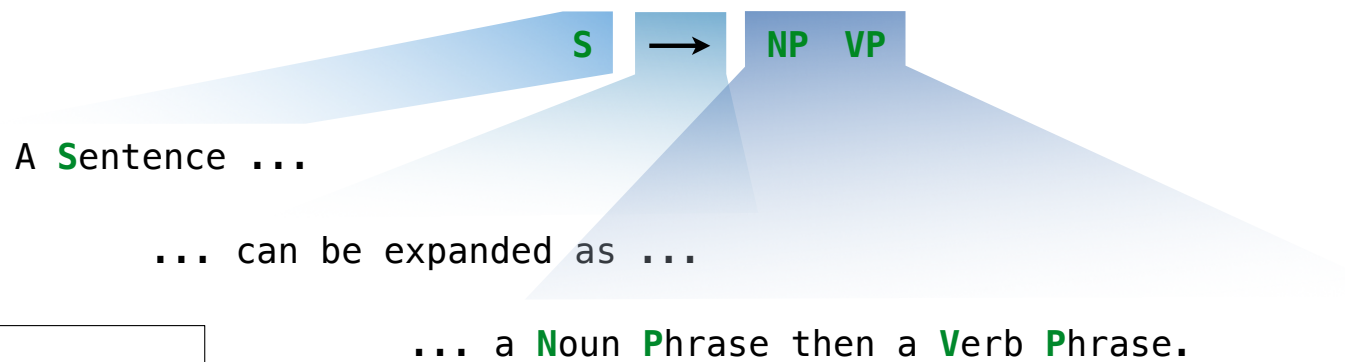

Grammar

S → **NP** **VP**

NP → **N**

N → COWS

VP → **V** **NP**

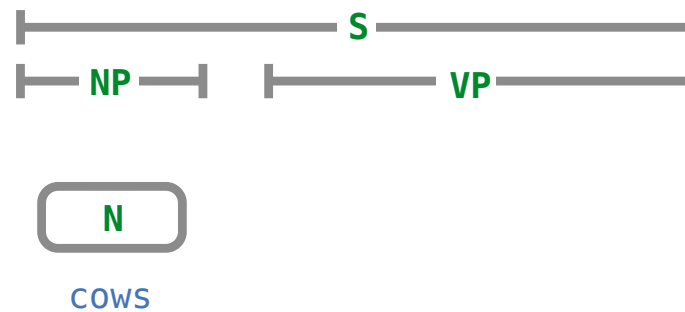

Context-Free Grammar Rules

A grammar rule describes how a tag can be expanded as a sequence of tags or words

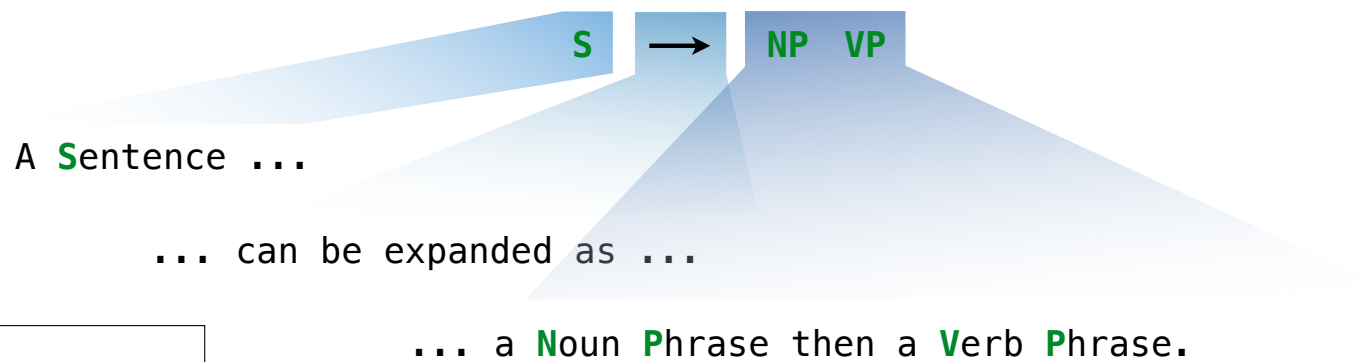

Grammar

S → **NP** **VP**

NP → **N**

N → **COWS**

VP → **V** **NP**

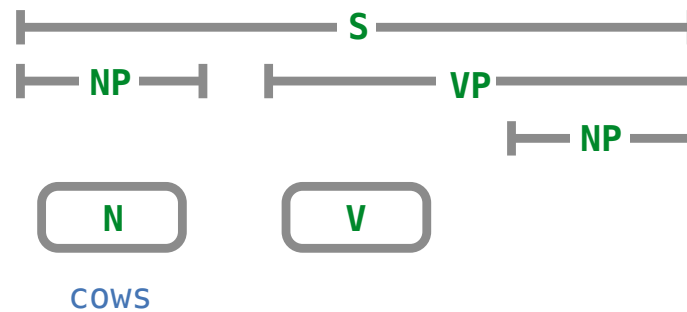

Context-Free Grammar Rules

A grammar rule describes how a tag can be expanded as a sequence of tags or words

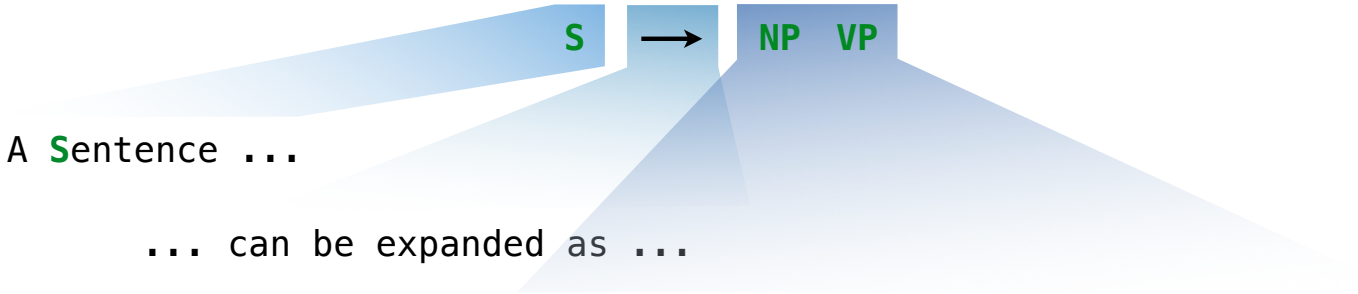

... a **Noun** **Phrase** then a **Verb** **Phrase**.

Grammar	
S	→ NP VP
NP	→ N
N	→ cows
VP	→ V NP
V	→ intimidate

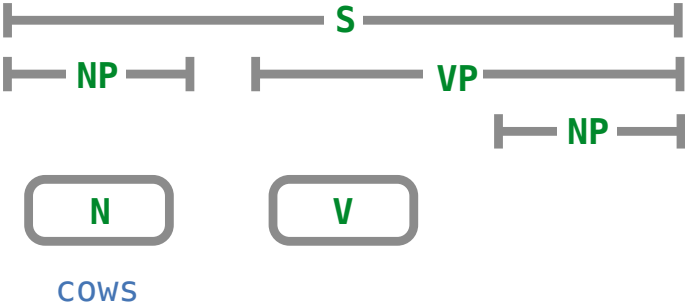

Context-Free Grammar Rules

A grammar rule describes how a tag can be expanded as a sequence of tags or words

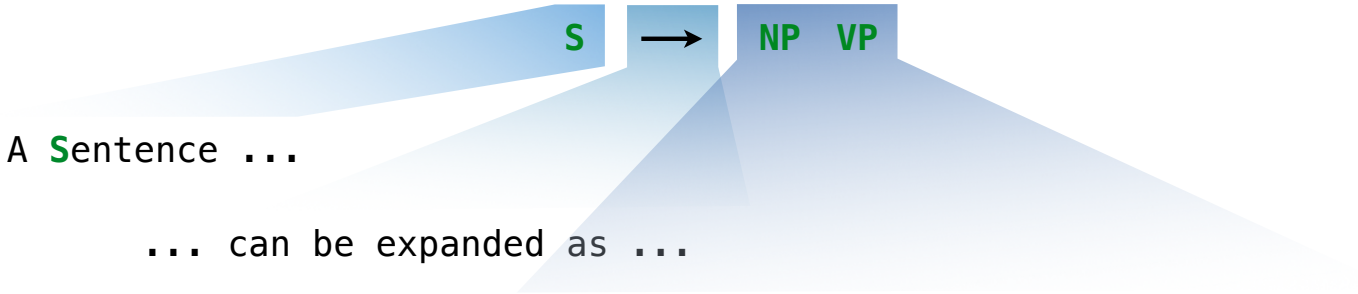

... a **Noun** **Phrase** then a **Verb** **Phrase**.

Grammar	
S	→ NP VP
NP	→ N
N	→ cows
VP	→ V NP
V	→ intimidate

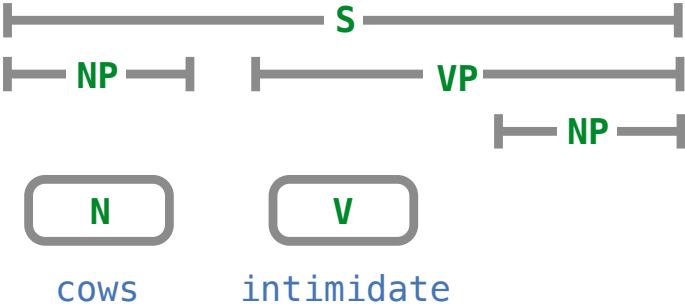

Context-Free Grammar Rules

A grammar rule describes how a tag can be expanded as a sequence of tags or words

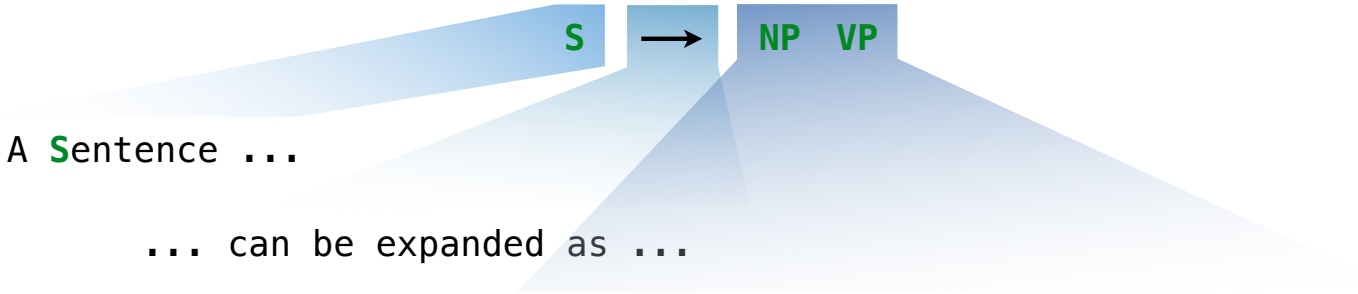

... a Noun Phrase then a Verb Phrase.

Grammar	
S	→ NP VP
NP	→ N
N	→ cows
VP	→ V NP
V	→ intimidate

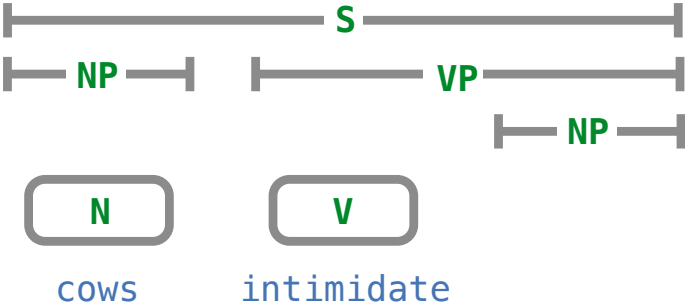

Context-Free Grammar Rules

A grammar rule describes how a tag can be expanded as a sequence of tags or words

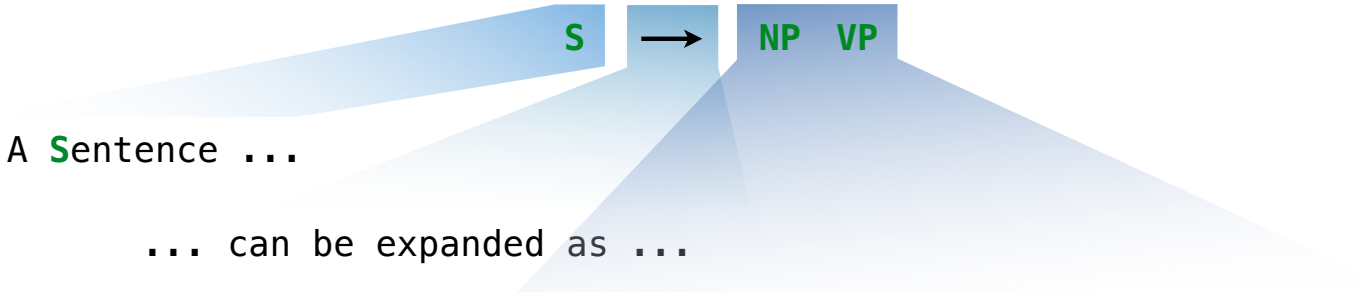

... a Noun Phrase then a Verb Phrase.

Grammar	
S	→ NP VP
NP	→ N
N	→ cows
VP	→ V NP
V	→ intimidate

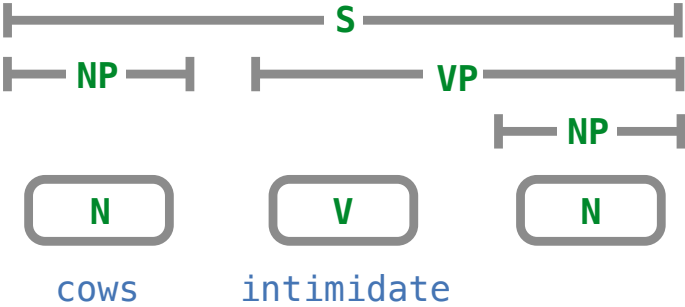

Context-Free Grammar Rules

A grammar rule describes how a tag can be expanded as a sequence of tags or words

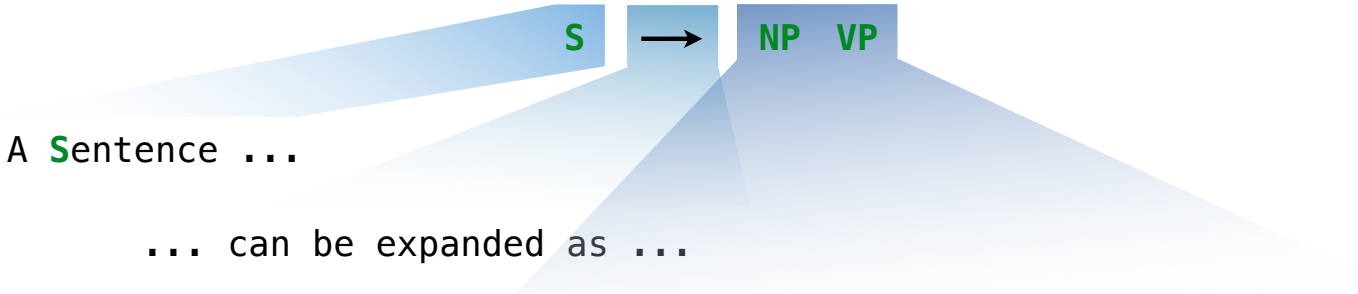

... a **Noun** **Phrase** then a **Verb** **Phrase**.

Grammar	
S	→ NP VP
NP	→ N
N	→ cows
VP	→ V NP
V	→ intimidate

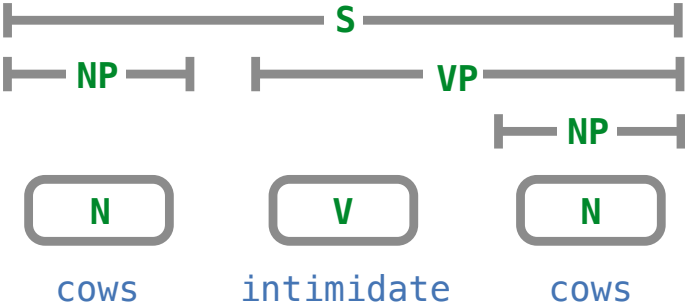

Context-Free Grammar Rules

A grammar rule describes how a tag can be expanded as a sequence of tags or words

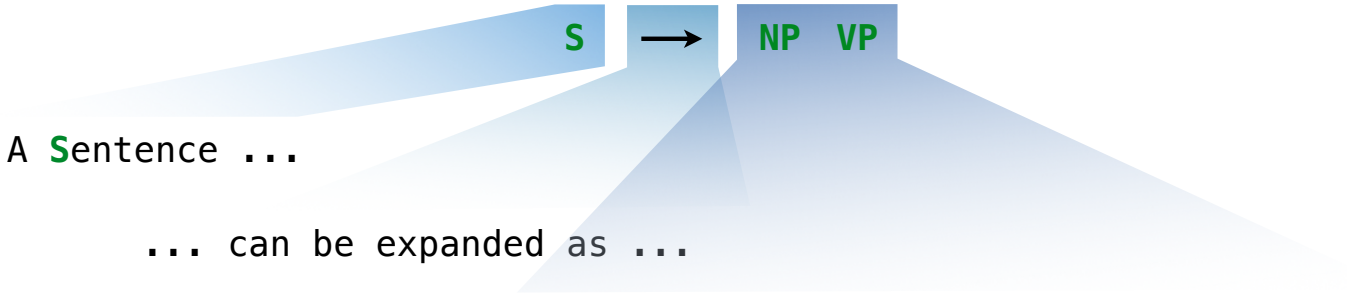

... a **Noun** **Phrase** then a **Verb** **Phrase**.

Grammar	
S	→ NP VP
NP	→ N
N	→ cows
VP	→ V NP
V	→ intimidate

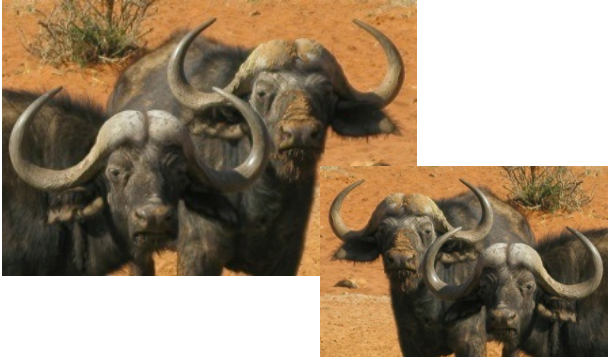
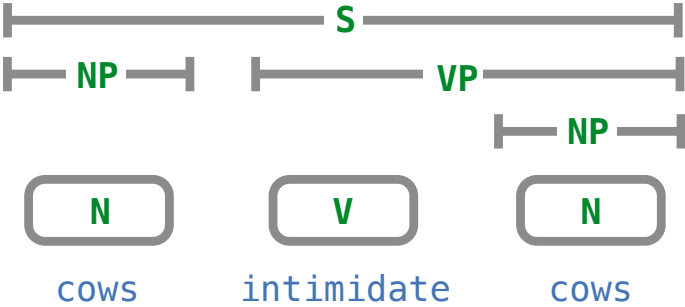

Context-Free Grammar Rules

A grammar rule describes how a tag can be expanded as a sequence of tags or words

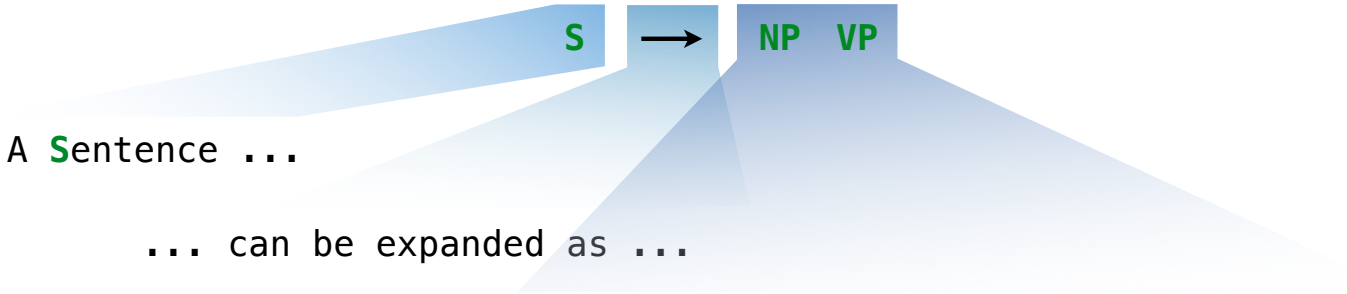

... a **Noun** **Phrase** then a **Verb** **Phrase**.

Grammar	
S	→ NP VP
NP	→ N
N	→ cows
VP	→ V NP
V	→ intimidate

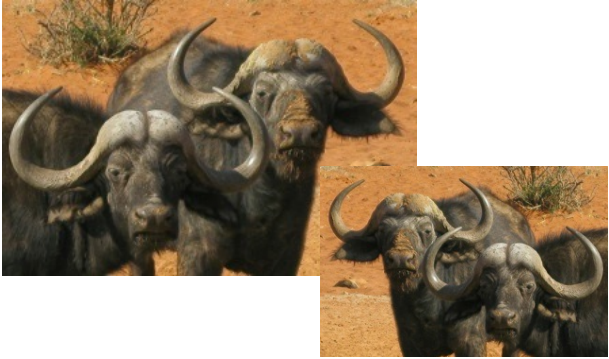
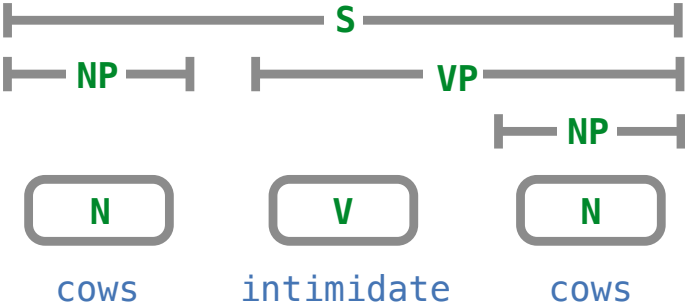

(Demo)

Parsing

Exhaustive Parsing

Expand all tags recursively, but constrain words to match input

Exhaustive Parsing

Expand all tags recursively, but constrain words to match input

buffalo buffalo buffalo buffalo

Exhaustive Parsing

Expand all tags recursively, but constrain words to match input



buffalo buffalo buffalo buffalo

Exhaustive Parsing

Expand all tags recursively, but constrain words to match input



buffalo buffalo buffalo buffalo



Exhaustive Parsing

Expand all tags recursively, but constrain words to match input



buffalo buffalo buffalo buffalo



Exhaustive Parsing

Expand all tags recursively, but constrain words to match input

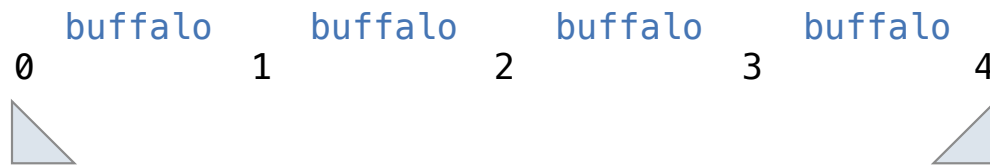

Exhaustive Parsing

Expand all tags recursively, but constrain words to match input

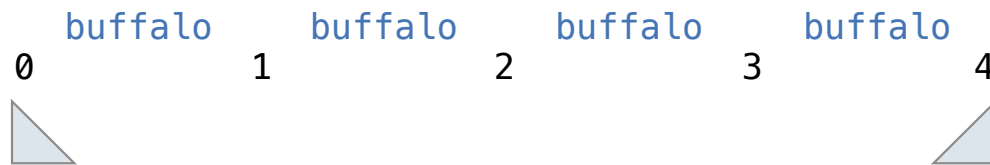
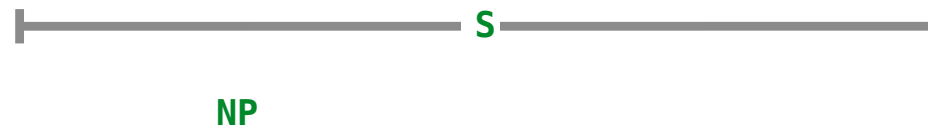

Exhaustive Parsing

Expand all tags recursively, but constrain words to match input

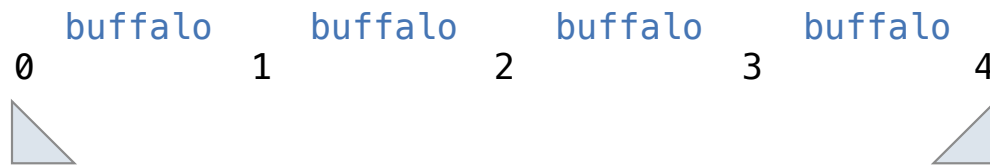
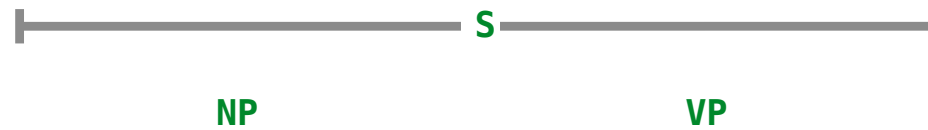

Exhaustive Parsing

Expand all tags recursively, but constrain words to match input

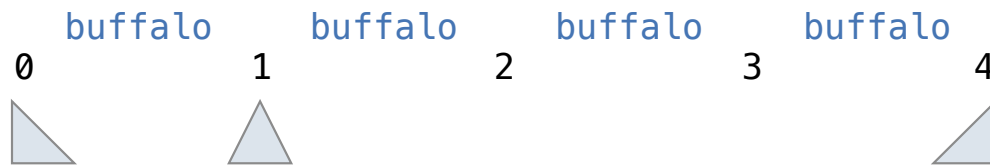
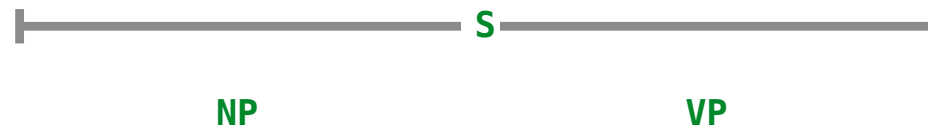

Exhaustive Parsing

Expand all tags recursively, but constrain words to match input

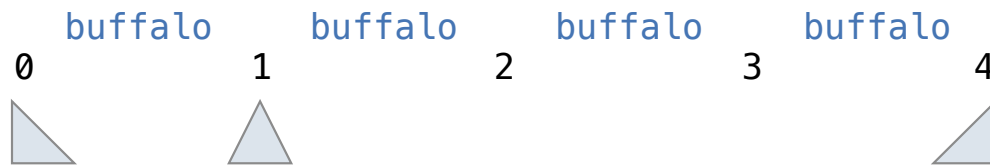

Exhaustive Parsing

Expand all tags recursively, but constrain words to match input

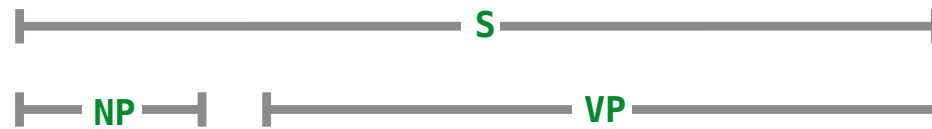

Exhaustive Parsing

Expand all tags recursively, but constrain words to match input

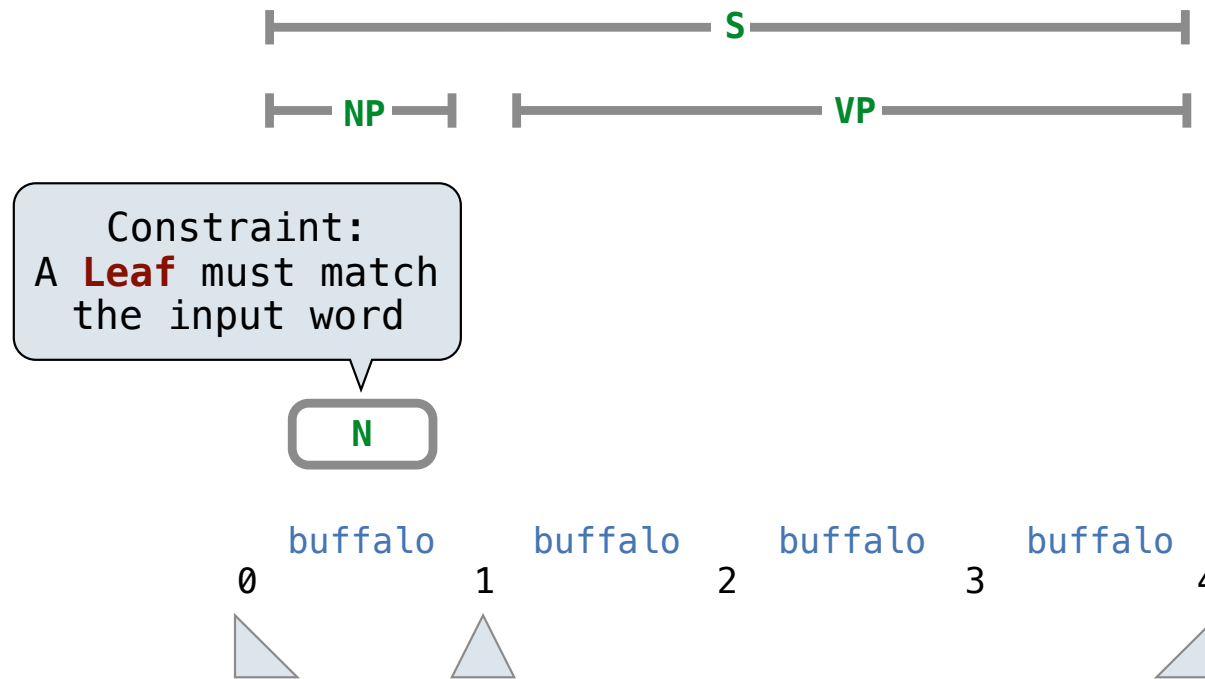

Exhaustive Parsing

Expand all tags recursively, but constrain words to match input

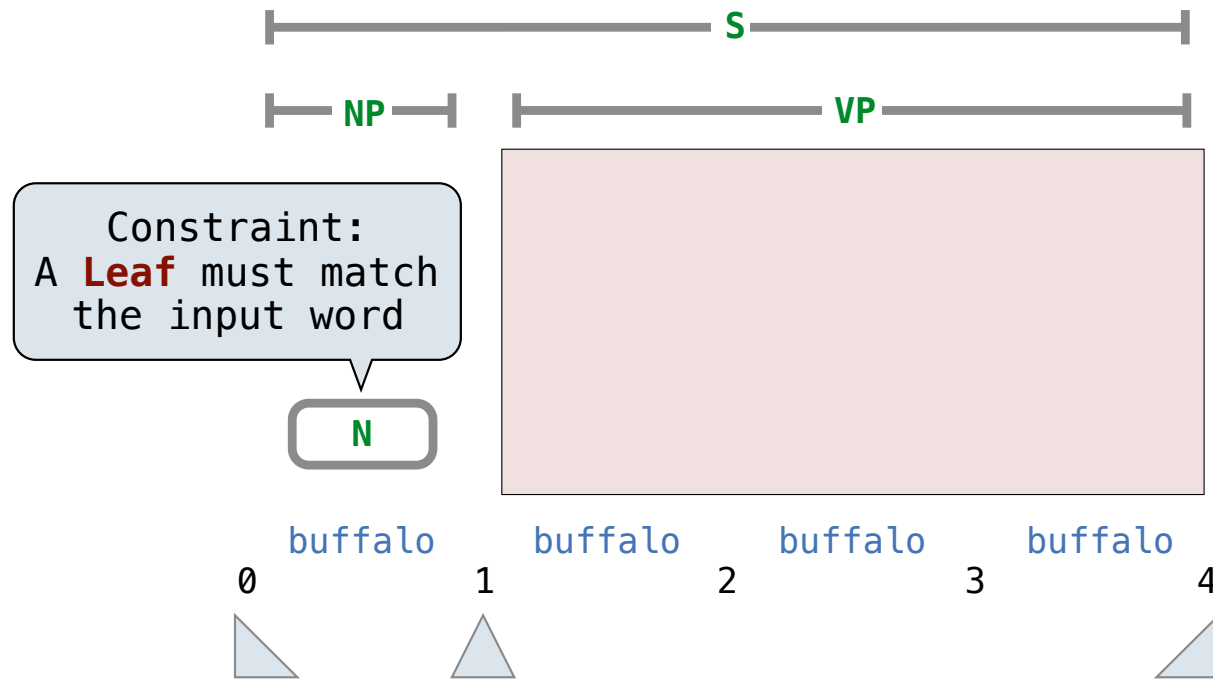

Exhaustive Parsing

Expand all tags recursively, but constrain words to match input

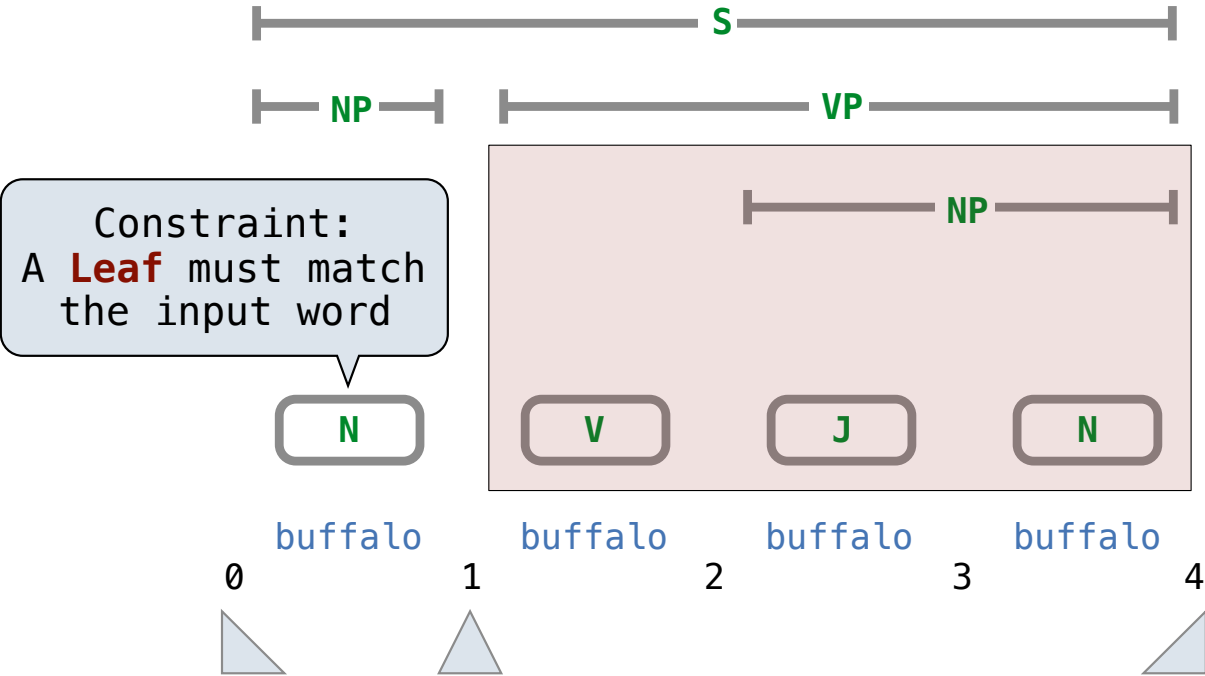

Exhaustive Parsing

Expand all tags recursively, but constrain words to match input

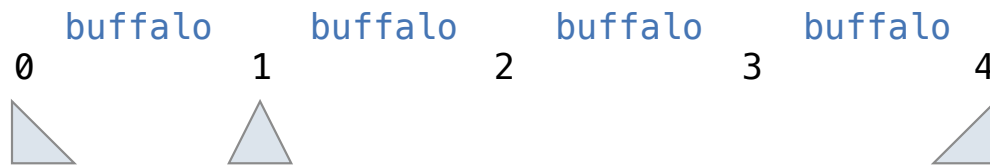
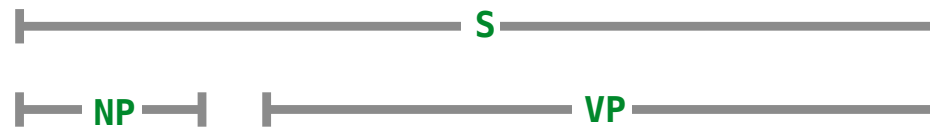

Exhaustive Parsing

Expand all tags recursively, but constrain words to match input

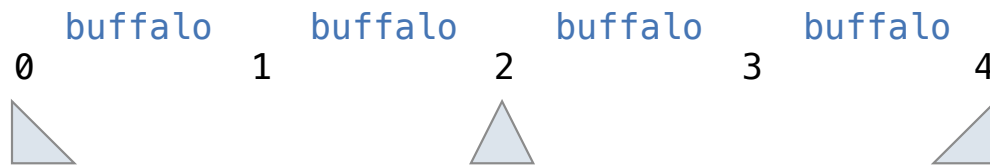

Exhaustive Parsing

Expand all tags recursively, but constrain words to match input

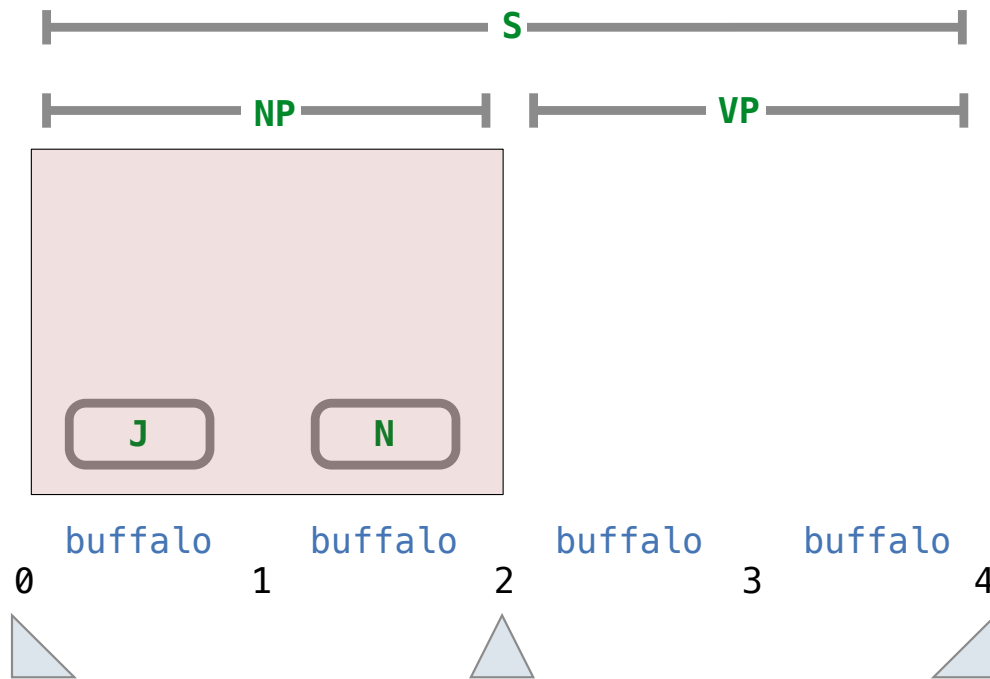

Exhaustive Parsing

Expand all tags recursively, but constrain words to match input

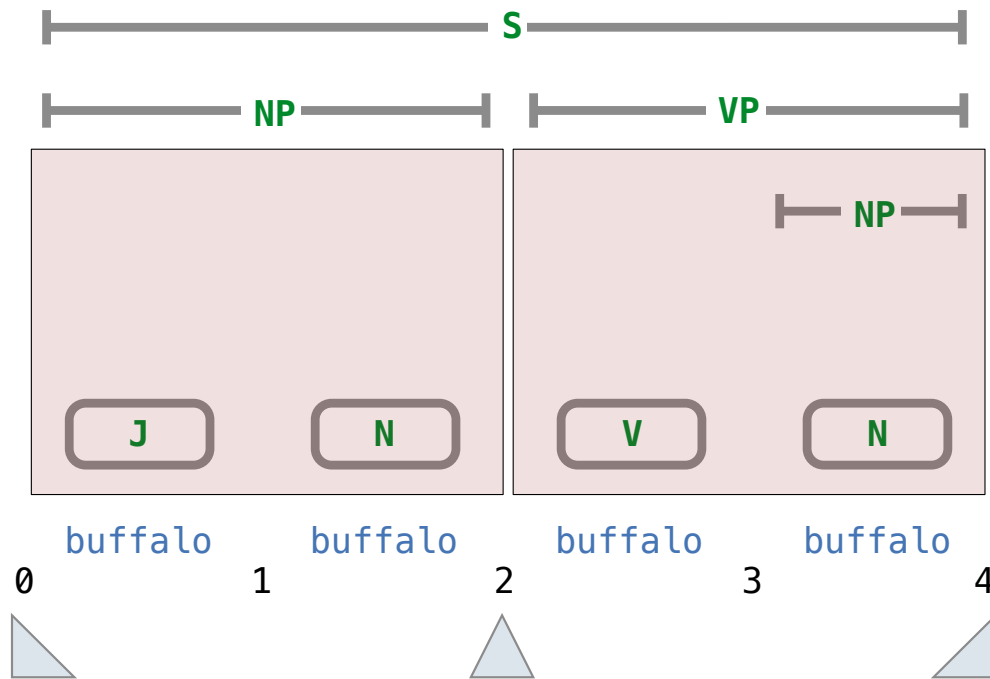

Exhaustive Parsing

Expand all tags recursively, but constrain words to match input

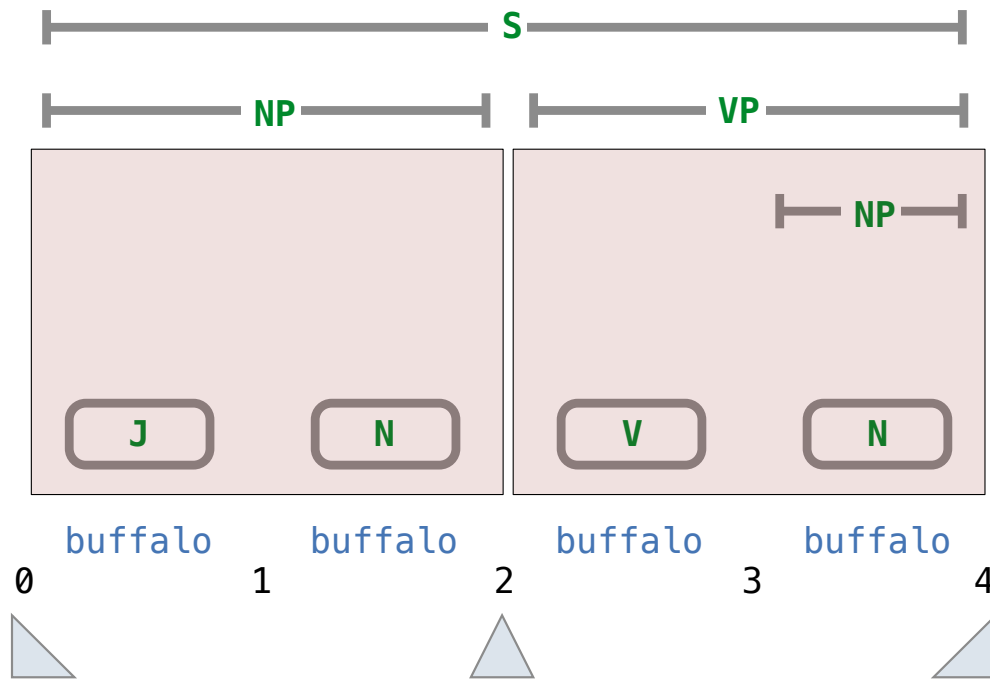

(Demo)

Learning

(Demo)

Scoring a Tree Using Relative Frequencies

Not all syntactic structures are equally common

Scoring a Tree Using Relative Frequencies

Not all syntactic structures are equally common

teacher strikes idle kids

Scoring a Tree Using Relative Frequencies

Not all syntactic structures are equally common



teacher strikes idle kids

Scoring a Tree Using Relative Frequencies

Not all syntactic structures are equally common

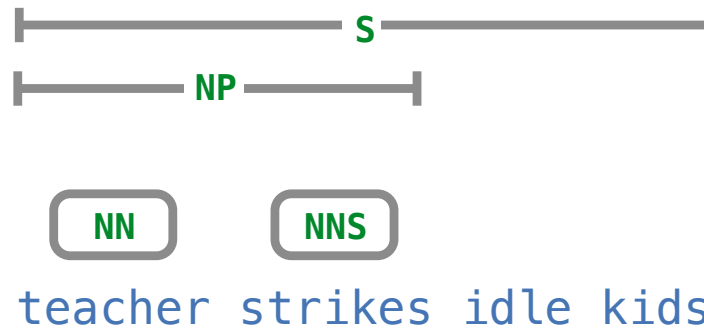

Scoring a Tree Using Relative Frequencies

Not all syntactic structures are equally common

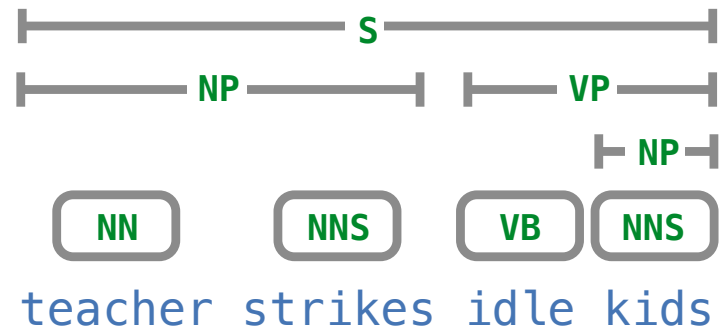

Scoring a Tree Using Relative Frequencies

Not all syntactic structures are equally common

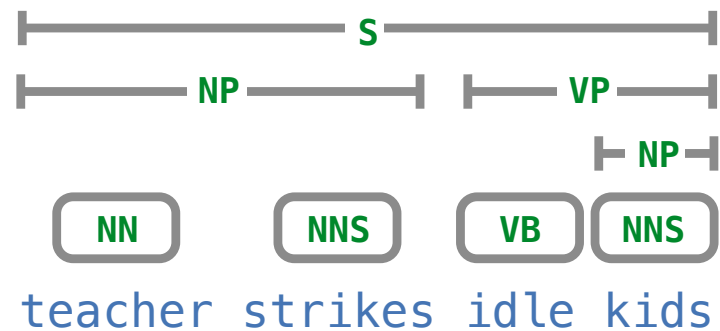

S → NP VP

NP → NN NNS

VP → VB NP

NP → NNS

NN → teacher

NNS → strikes

VB → idle

NNS → kids

Scoring a Tree Using Relative Frequencies

Not all syntactic structures are equally common

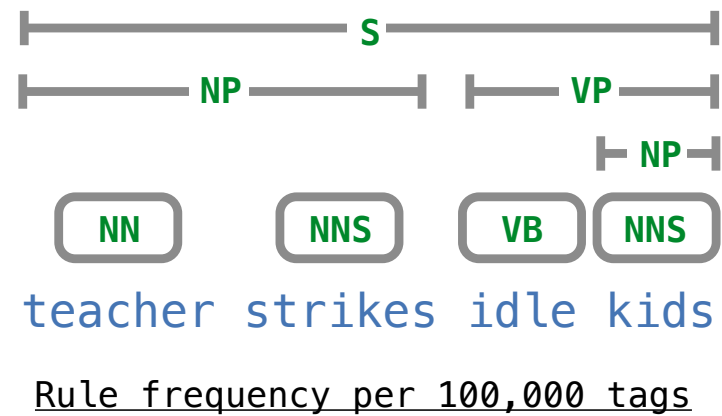

S → NP VP

NP → NN NNS

VP → VB NP

NP → NNS

NN → teacher

NNS → strikes

VB → idle

NNS → kids

Scoring a Tree Using Relative Frequencies

Not all syntactic structures are equally common

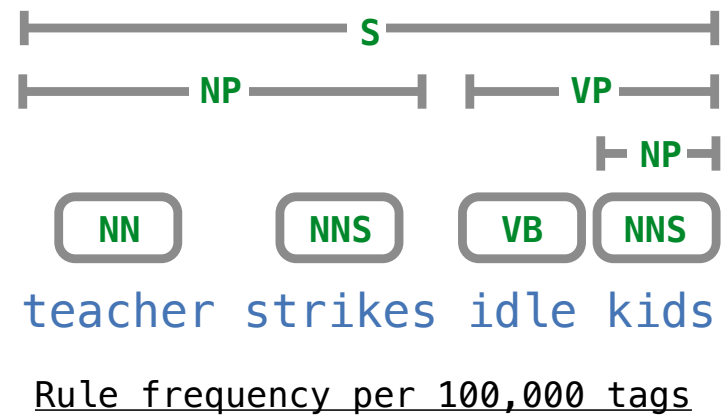

S	→	NP	VP	25372	NN	→	teacher
NP	→	NN	NNS		NNS	→	strikes
VP	→	VB	NP		VB	→	idle
NP	→	NNS			NNS	→	kids

Scoring a Tree Using Relative Frequencies

Not all syntactic structures are equally common

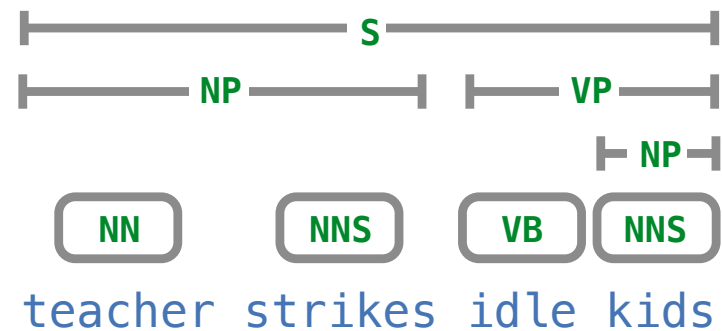

Rule frequency per 100,000 tags

S	→	NP	VP	25372	NN	→	teacher
NP	→	NN	NNS	1335	NNS	→	strikes
VP	→	VB	NP		VB	→	idle
NP	→	NNS			NNS	→	kids

Scoring a Tree Using Relative Frequencies

Not all syntactic structures are equally common

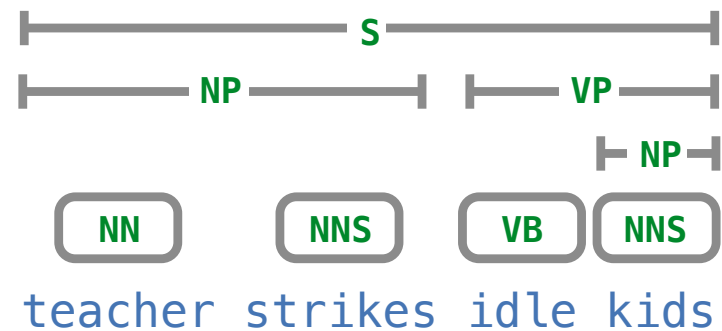

Rule frequency per 100,000 tags

S	→	NP	VP	25372	NN	→	teacher
NP	→	NN	NNS	1335	NNS	→	strikes
VP	→	VB	NP	6679	VB	→	idle
NP	→	NNS			NNS	→	kids

Scoring a Tree Using Relative Frequencies

Not all syntactic structures are equally common

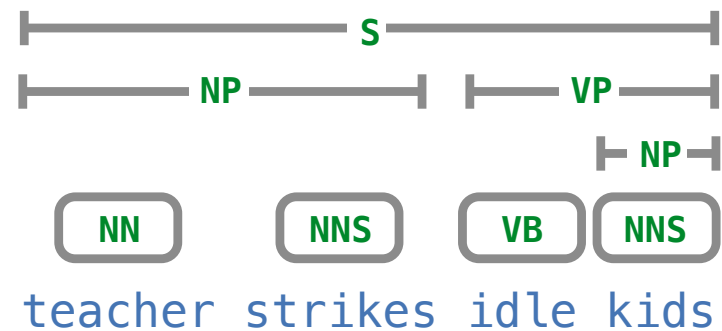

Rule frequency per 100,000 tags

S	→	NP	VP	25372	NN	→	teacher
NP	→	NN	NNS	1335	NNS	→	strikes
VP	→	VB	NP	6679	VB	→	idle
NP	→	NNS		4282	NNS	→	kids

Scoring a Tree Using Relative Frequencies

Not all syntactic structures are equally common

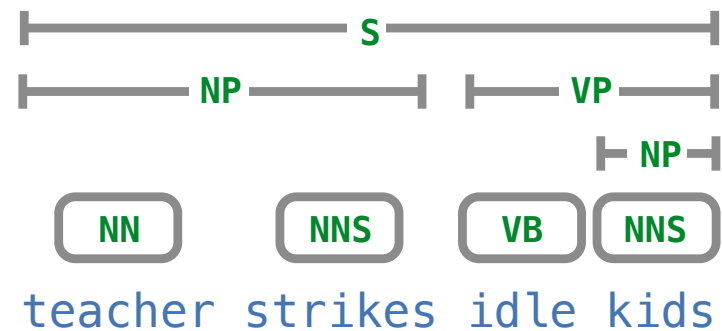

Rule frequency per 100,000 tags

S	→	NP	VP	25372	NN	→	teacher	5
NP	→	NN	NNS	1335	NNS	→	strikes	
VP	→	VB	NP	6679	VB	→	idle	
NP	→	NNS		4282	NNS	→	kids	

Scoring a Tree Using Relative Frequencies

Not all syntactic structures are equally common

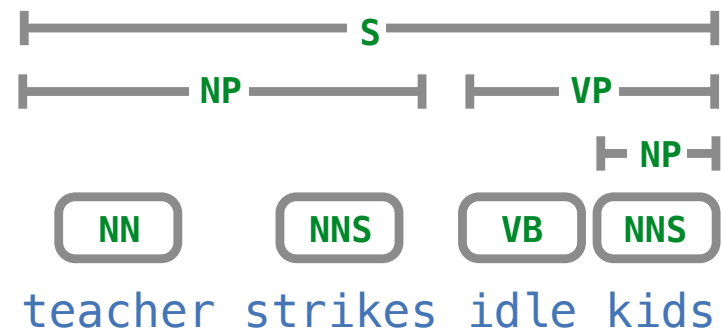

Rule frequency per 100,000 tags

S	→	NP	VP	25372	NN	→	teacher	5
NP	→	NN	NNS	1335	NNS	→	strikes	25
VP	→	VB	NP	6679	VB	→	idle	
NP	→	NNS		4282	NNS	→	kids	

Scoring a Tree Using Relative Frequencies

Not all syntactic structures are equally common

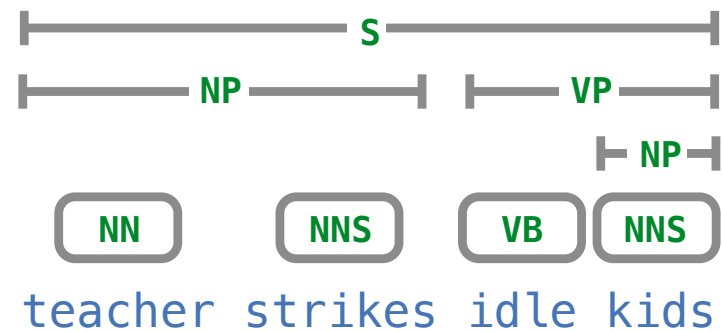

Rule frequency per 100,000 tags

S	→	NP	VP	25372	NN	→	teacher	5
NP	→	NN	NNS	1335	NNS	→	strikes	25
VP	→	VB	NP	6679	VB	→	idle	26
NP	→	NNS		4282	NNS	→	kids	

Scoring a Tree Using Relative Frequencies

Not all syntactic structures are equally common

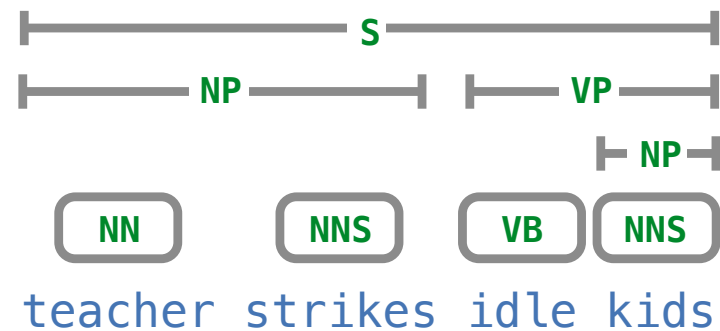

Rule frequency per 100,000 tags

S	→	NP	VP	25372	NN	→	teacher	5
NP	→	NN	NNS	1335	NNS	→	strikes	25
VP	→	VB	NP	6679	VB	→	idle	26
NP	→	NNS		4282	NNS	→	kids	32

Scoring a Tree Using Relative Frequencies

Not all syntactic structures are equally common

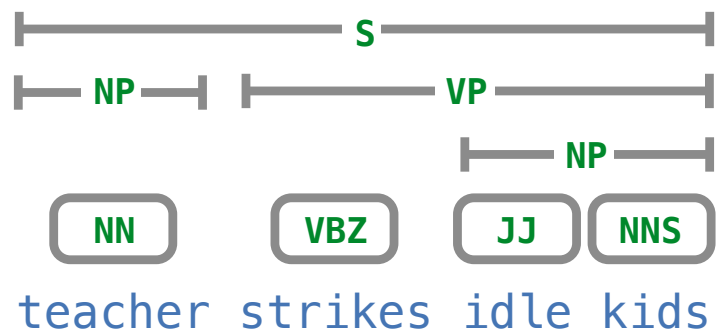

Rule frequency per 100,000 tags

S	→	NP	VP	25372	NN	→	teacher	5	
NP	→	NN		1335	4358	VBZ	→	strikes	25 19
VP	→	VBZ	NP	6679	3160	JJ	→	idle	26 18
NP	→	JJ	NNS	4282	2526	NNS	→	kids	32

Scoring a Tree Using Relative Frequencies

Not all syntactic structures are equally common

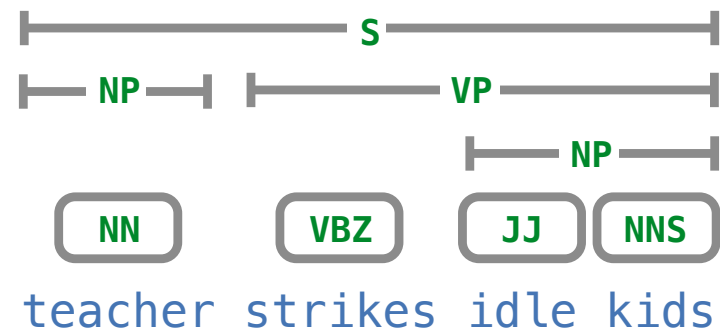

Rule frequency per 100,000 tags

S	→	NP	VP	25372	NN	→	teacher	5	
NP	→	NN		1335	4358	VBZ	→	strikes	25 19
VP	→	VBZ	NP	6679	3160	JJ	→	idle	26 18
NP	→	JJ	NNS	4282	2526	NNS	→	kids	32

(Demo)

Translation

Syntactic Reordering

Syntactic Reordering

English

Syntactic Reordering

English

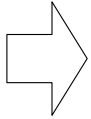

Yoda-English



Syntactic Reordering

English

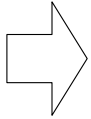

Yoda-English

Help you, I can!
Yes! Mm!

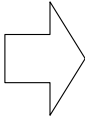

Syntactic Reordering

English  Yoda-English

Help you, I can!
Yes! Mm!



When 900 years old you reach,
look as good, you will not. Hm.

Syntactic Reordering

English

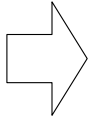

Yoda-English

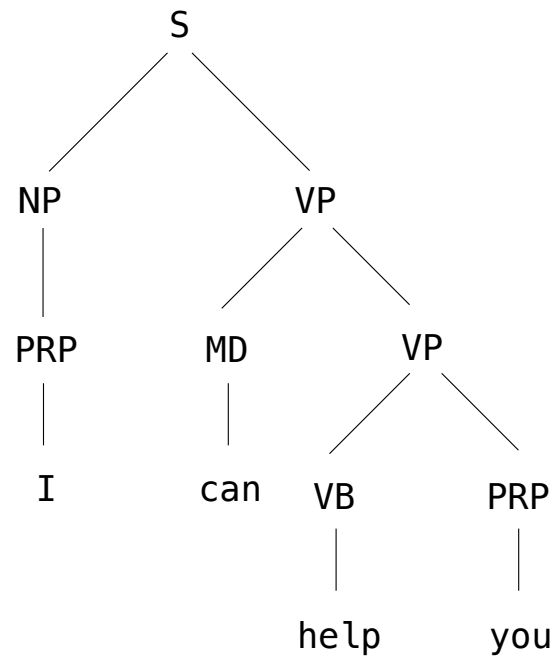

Help you, I can!
Yes! Mm!



When 900 years old you reach,
look as good, you will not. Hm.

Syntactic Reordering

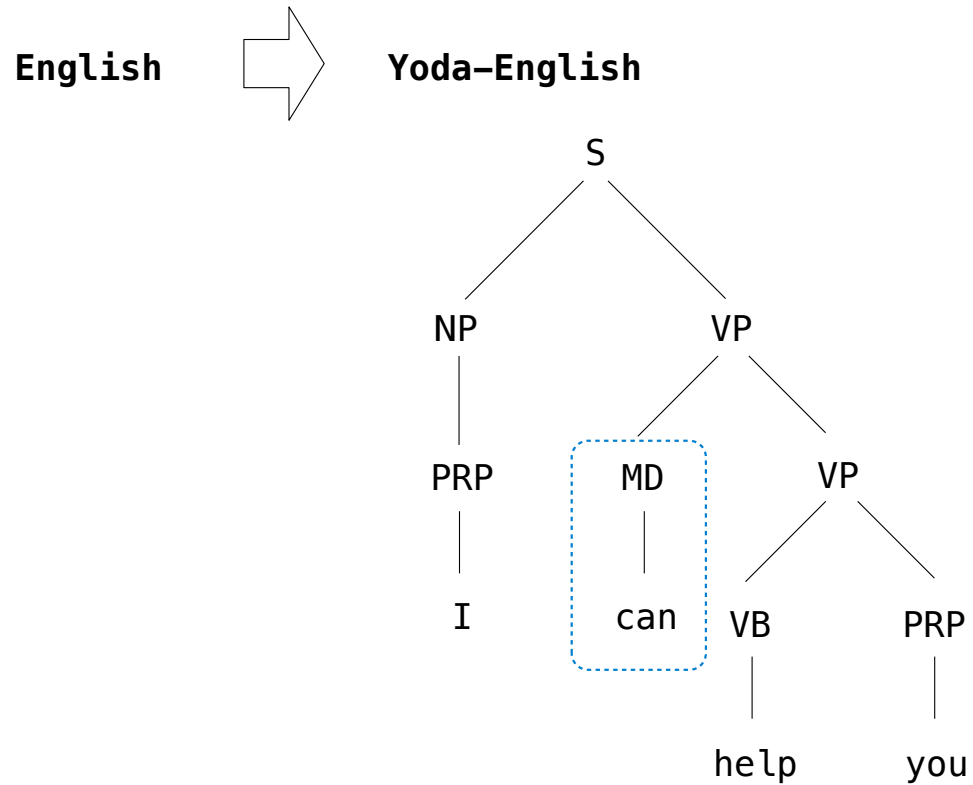

Help you, I can!
Yes! Mm!



When 900 years old you reach,
look as good, you will not. Hm.

Syntactic Reordering

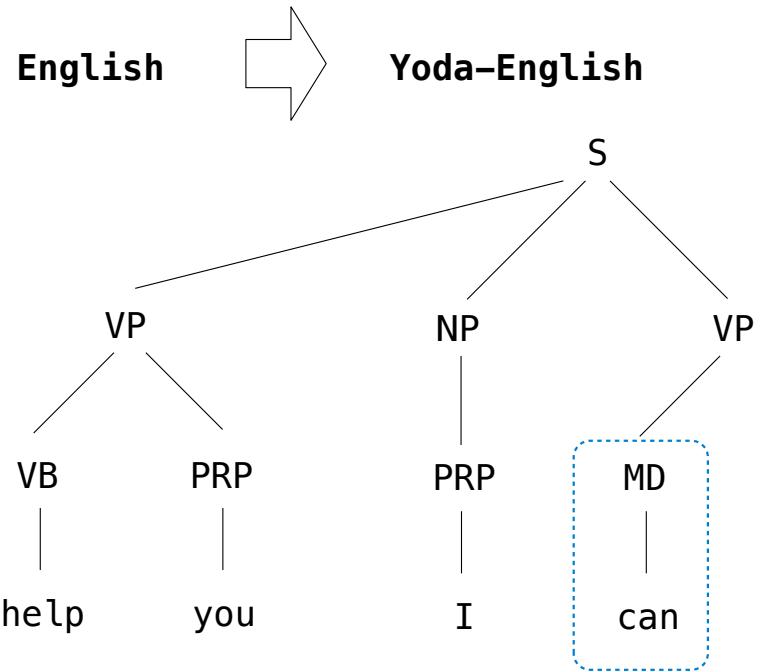

Help you, I can!
Yes! Mm!

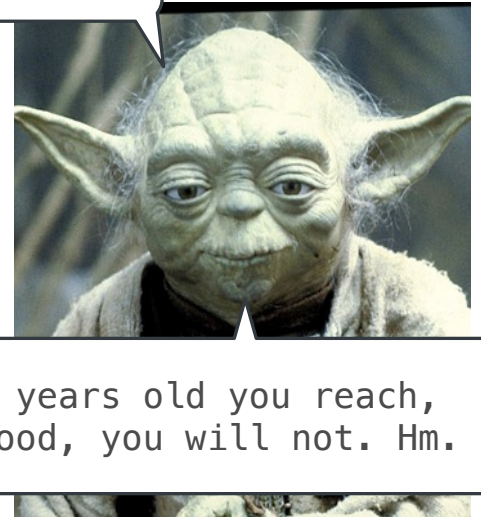

When 900 years old you reach,
look as good, you will not. Hm.

Syntactic Reordering

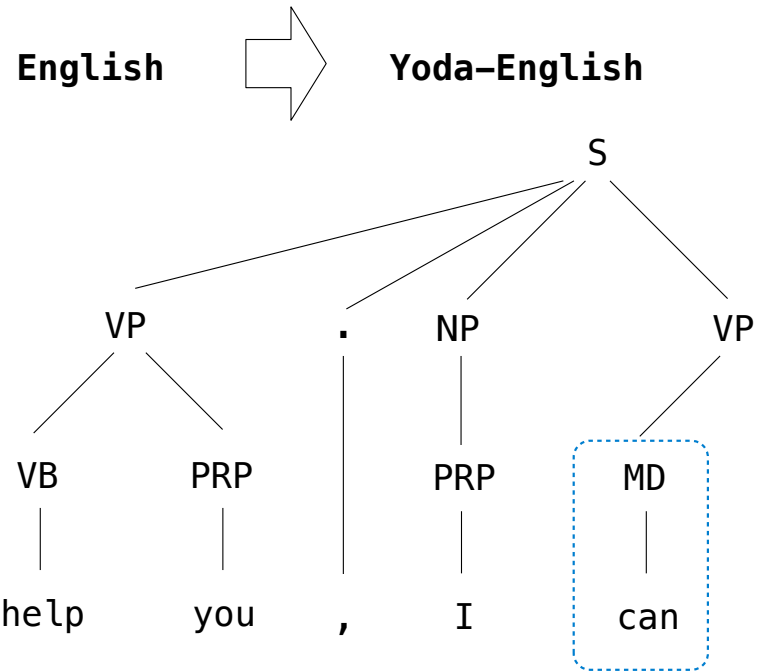

Help you, I can!
Yes! Mm!



When 900 years old you reach,
look as good, you will not. Hm.

Syntactic Reordering

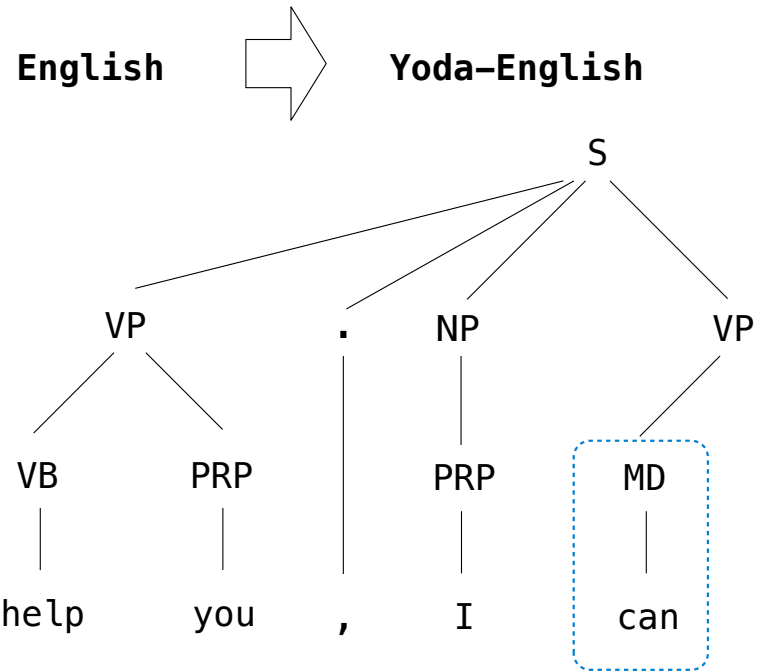

Help you, I can!
Yes! Mm!

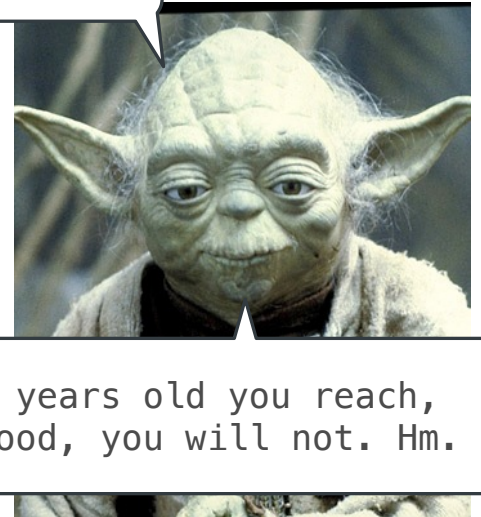

When 900 years old you reach,
look as good, you will not. Hm.

(Demo)