

CS162  
Operating Systems and  
Systems Programming  
Lecture 1

What is an Operating System?

January 17<sup>th</sup>, 2023

Prof. John Kubiatowicz

<http://cs162.eecs.Berkeley.edu>

# Goals for Today

---

- What is an Operating System?
  - And – what is it not?
- What makes Operating Systems so exciting?
- Oh, and “How does this class operate?”

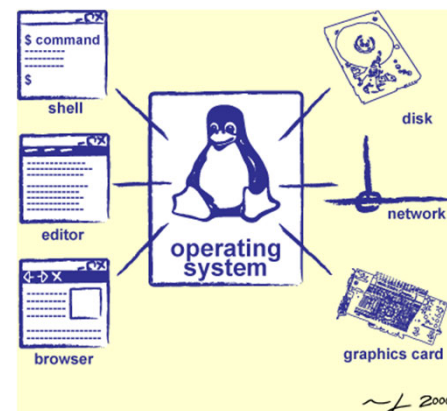

Interactive is important!

Ask Questions!

Slides courtesy of David Culler, Anthony D. Joseph, John Kubiawicz, AJ Shankar, George Necula, Alex Aiken, Eric Brewer, Ras Bodik, Ion Stoica, Doug Tygar, and David Wagner.

# Greatest Artifact of Human Civilization...

---

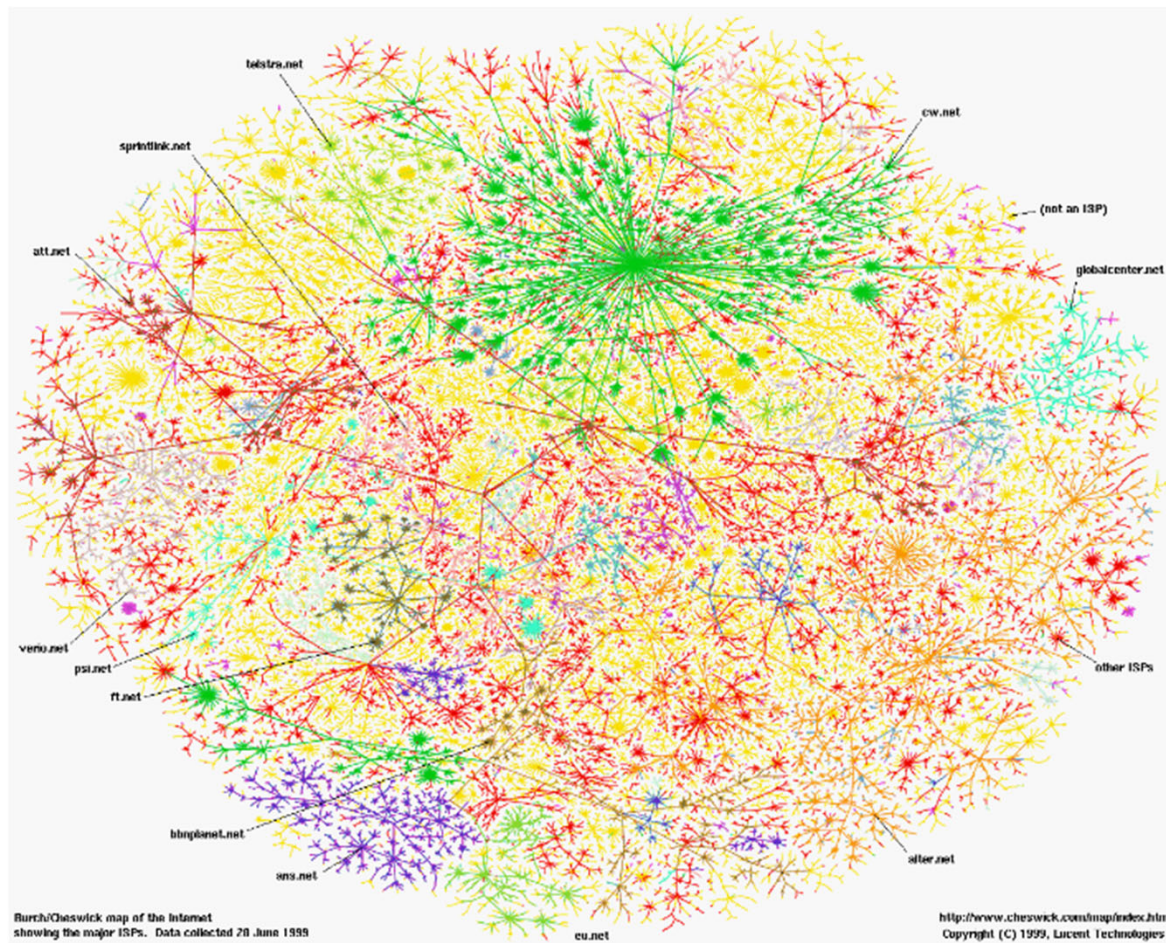



# Greatest Artifact of Human Civilization...

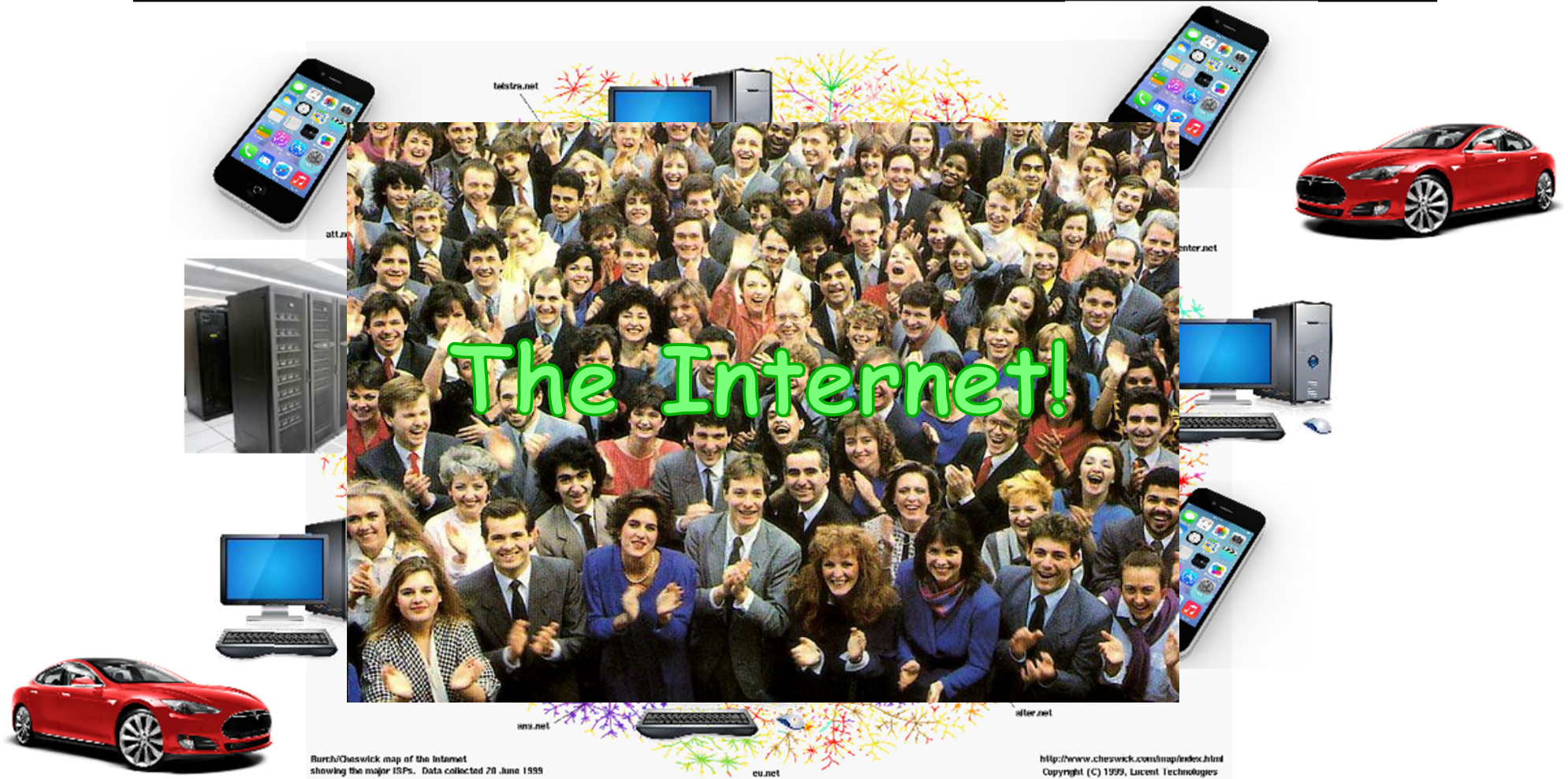

# Running Systems at Internet Scale

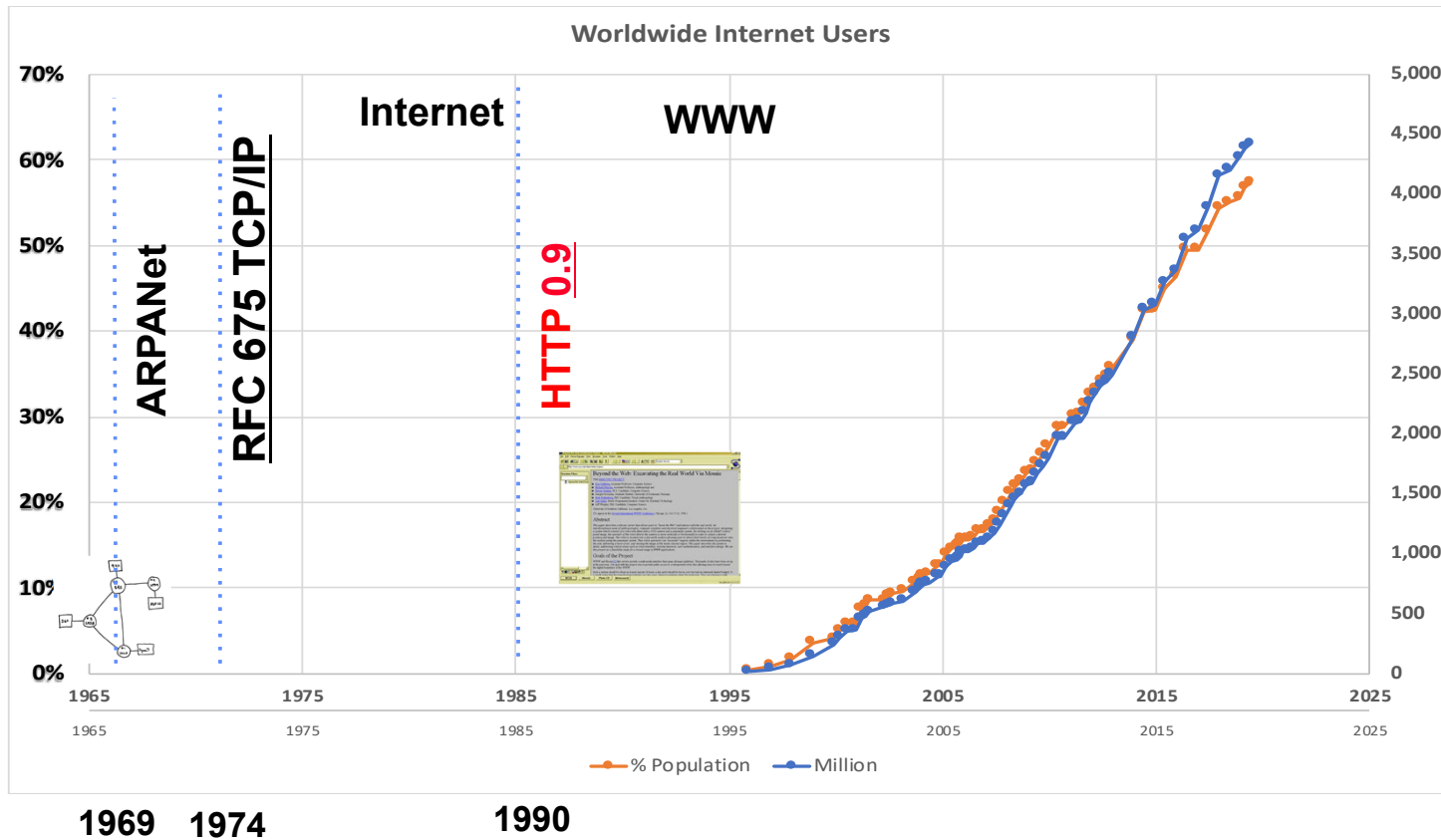

# Across Incredible Diversity

**Bell's Law:  
New  
computer  
class every  
10 years**

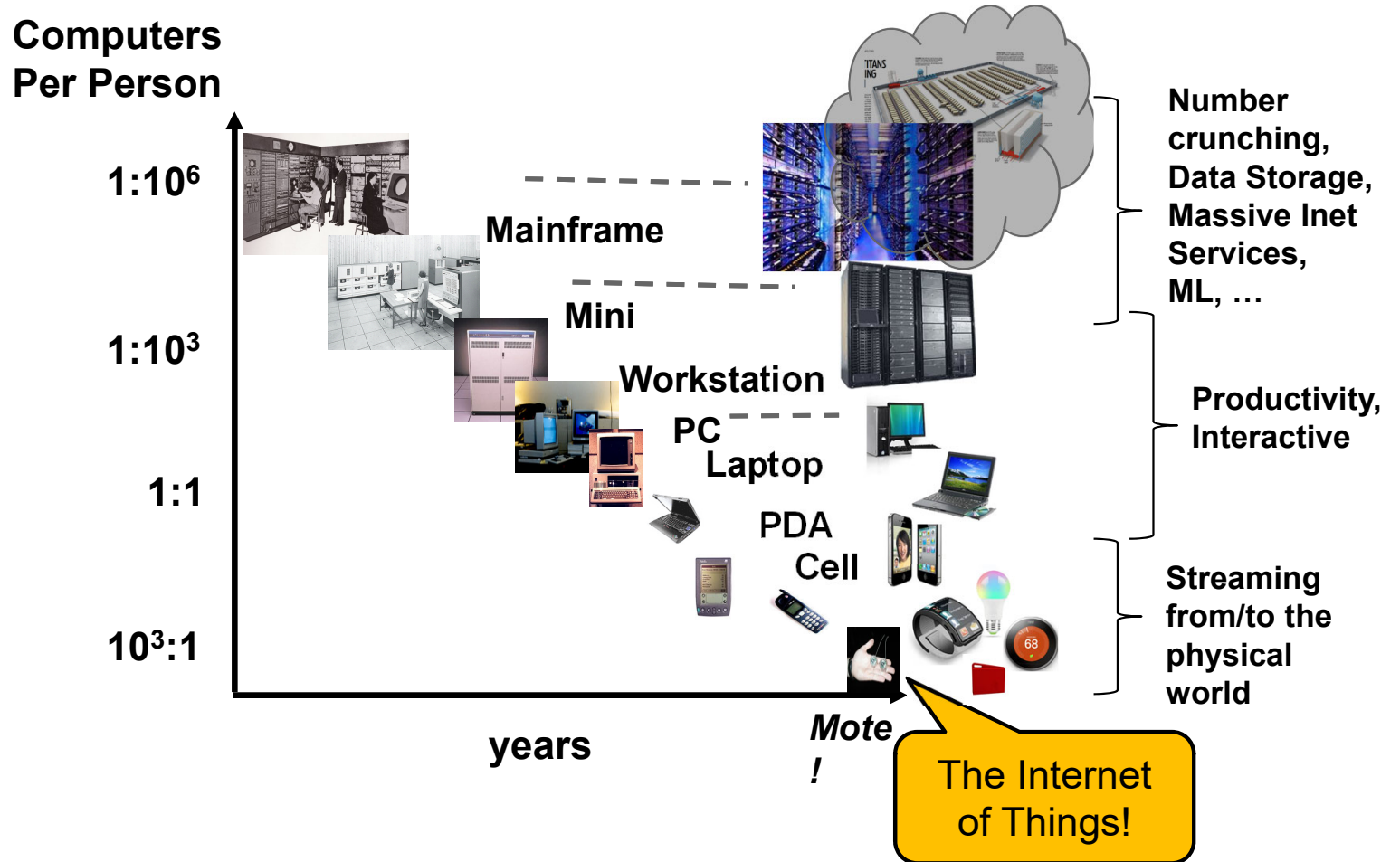

## And Range of Timescales

---

### Jeff Dean: “Numbers Everyone Should Know”

L1 cache reference	0.5 ns
Branch mispredict	5 ns
L2 cache reference	7 ns
Mutex lock/unlock	25 ns
Main memory reference	100 ns
Compress 1K bytes with Zippy	3,000 ns
Send 2K bytes over 1 Gbps network	20,000 ns
Read 1 MB sequentially from memory	250,000 ns
Round trip within same datacenter	500,000 ns
Disk seek	10,000,000 ns
Read 1 MB sequentially from disk	20,000,000 ns
Send packet CA->Netherlands->CA	150,000,000 ns

# Operating Systems are at the Heart of it All!

---

- Make the incredible advance in the underlying technology available to a rapidly evolving body of applications
  - Provide **consistent abstractions** to applications, even on different hardware
  - Manage **sharing of resources** among multiple applications
- The key building blocks:
  - Processes
  - Threads, Concurrency, Scheduling, Coordination
  - Address Spaces
  - Protection, Isolation, Sharing, Security
  - Communication, Protocols
  - Persistent storage, transactions, consistency, resilience
  - Interfaces to all devices



## Example: What's in a Search Query?

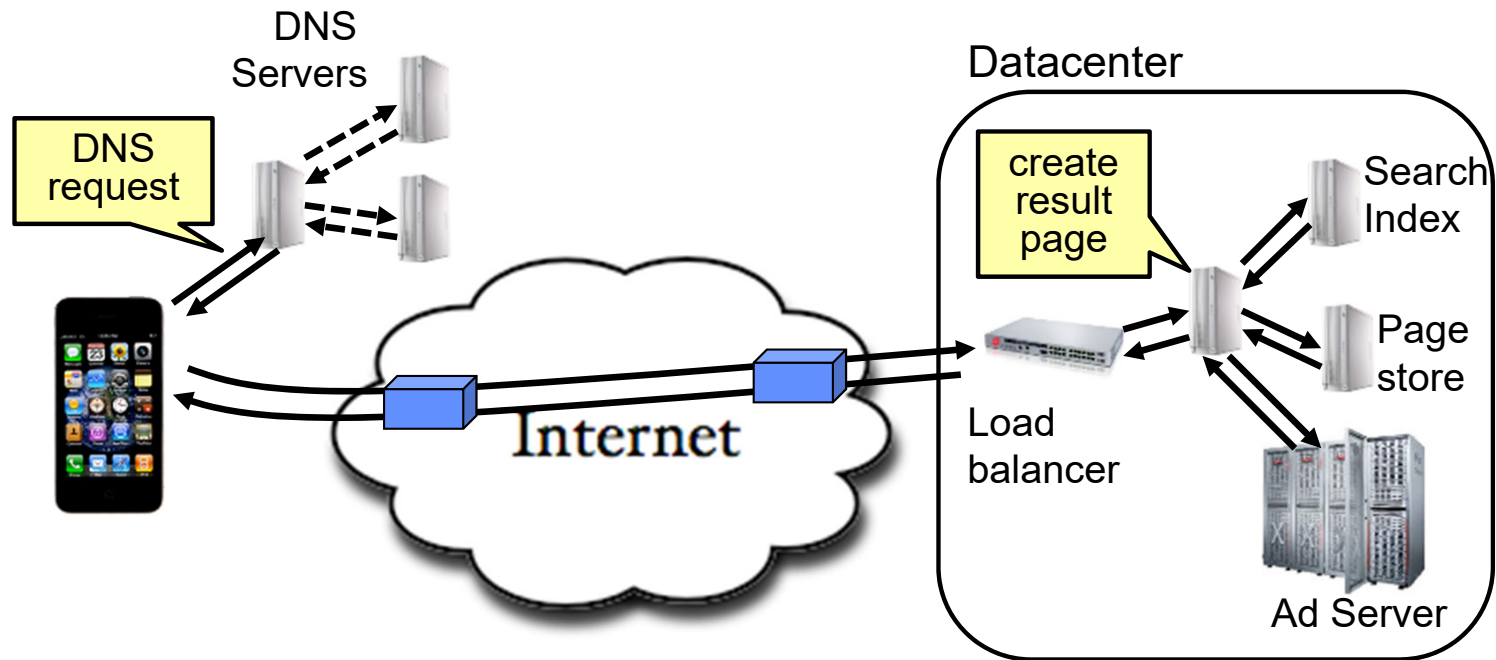

- Complex interaction of multiple components in multiple administrative domains
  - Systems, services, protocols, ...

---

But: What is an operating system?

# What does an Operating System *do*?

---

- Most Likely:
  - Memory Management
  - I/O Management
  - CPU Scheduling
  - Communications? (Does Email belong in OS?)
  - Multitasking/multiprogramming?
- What about?
  - File System?
  - Multimedia Support?
  - User Interface?
  - Internet Browser? 😊
- Is this only interesting to Academics??

# Definition of an Operating System

---

- No universally accepted definition
- “Everything a vendor ships when you order an operating system” is good approximation
  - But varies wildly
- “The one program running at all times on the computer” is the **kernel**
  - Everything else is either a system program (ships with the operating system) or an application program

# One Definition of an Operating System

---

- Special layer of software that provides application software access to hardware resources
  - Convenient abstraction of complex hardware devices
  - Protected access to shared resources
  - Security and authentication
  - Communication

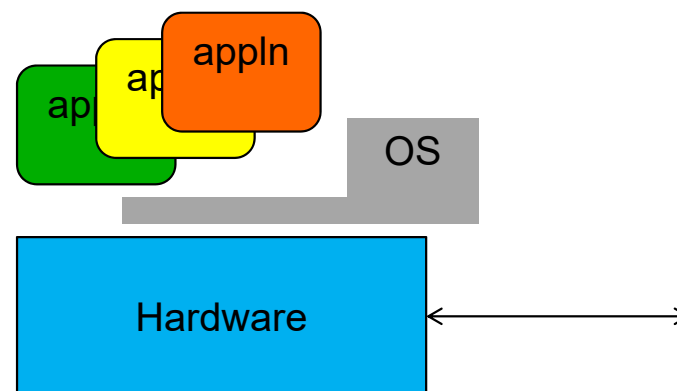



# Operating System



Switchboard Operator



Computer Operators

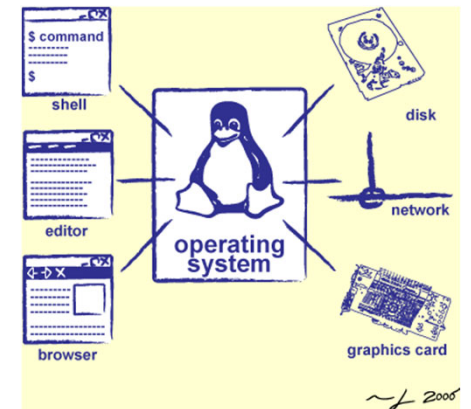

Operating System

## What makes something a **system**?

- Multiple interrelated parts
  - Each potentially interacts with the others
- Robustness requires an **engineering mindset**
  - Meticulous error handling, defending against malicious careless users
  - Treating the computer as a concrete machine, with all of its limitations and possible failure cases

***System programming is an important part of this class!***

# Hardware/Software Interface

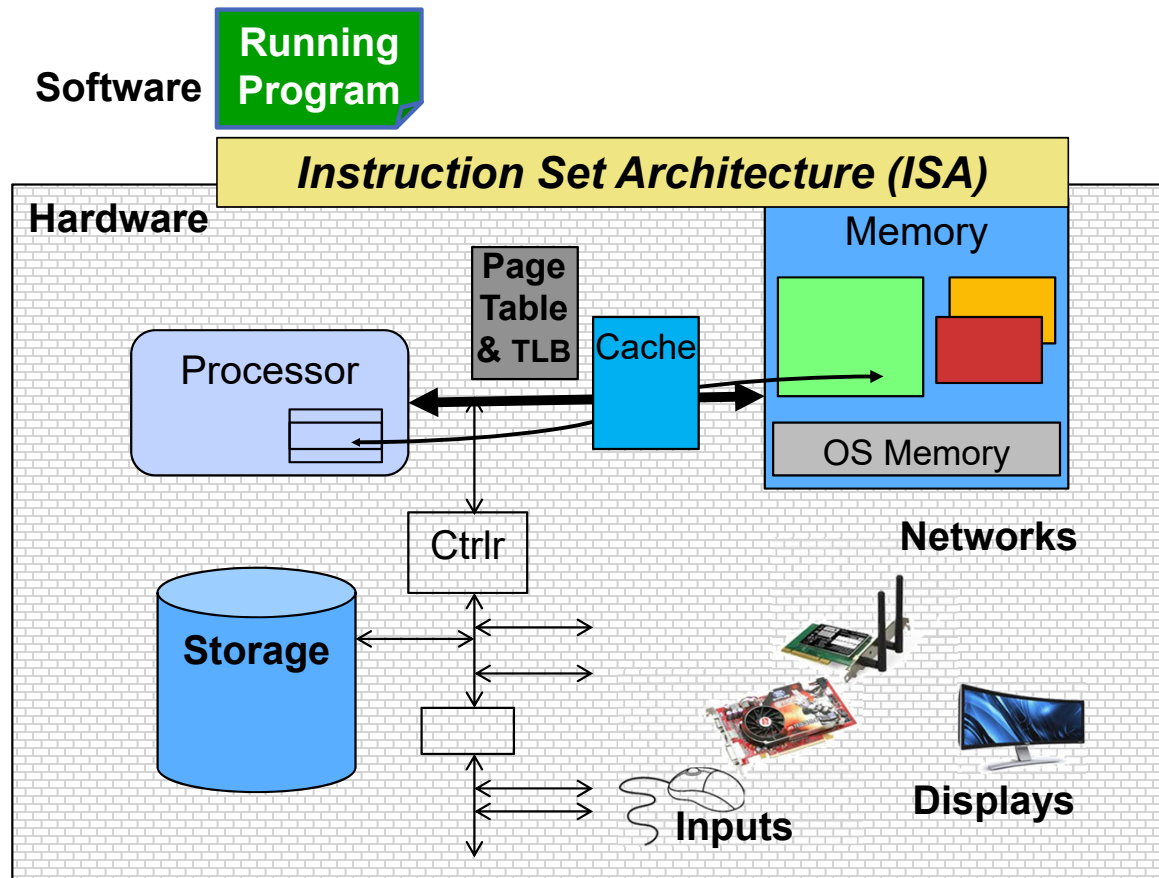

What you learned in  
**CS 61C – Machine  
Structures (and C)**

The OS *abstracts*  
these hardware details  
from the application

# What is an Operating System?

---



- **Illusionist**
  - Provide clean, easy-to-use abstractions of physical resources
    - » Infinite memory, dedicated machine
    - » Higher level objects: files, users, messages
    - » Masking limitations, virtualization

# OS Basics: Virtualizing the Machine

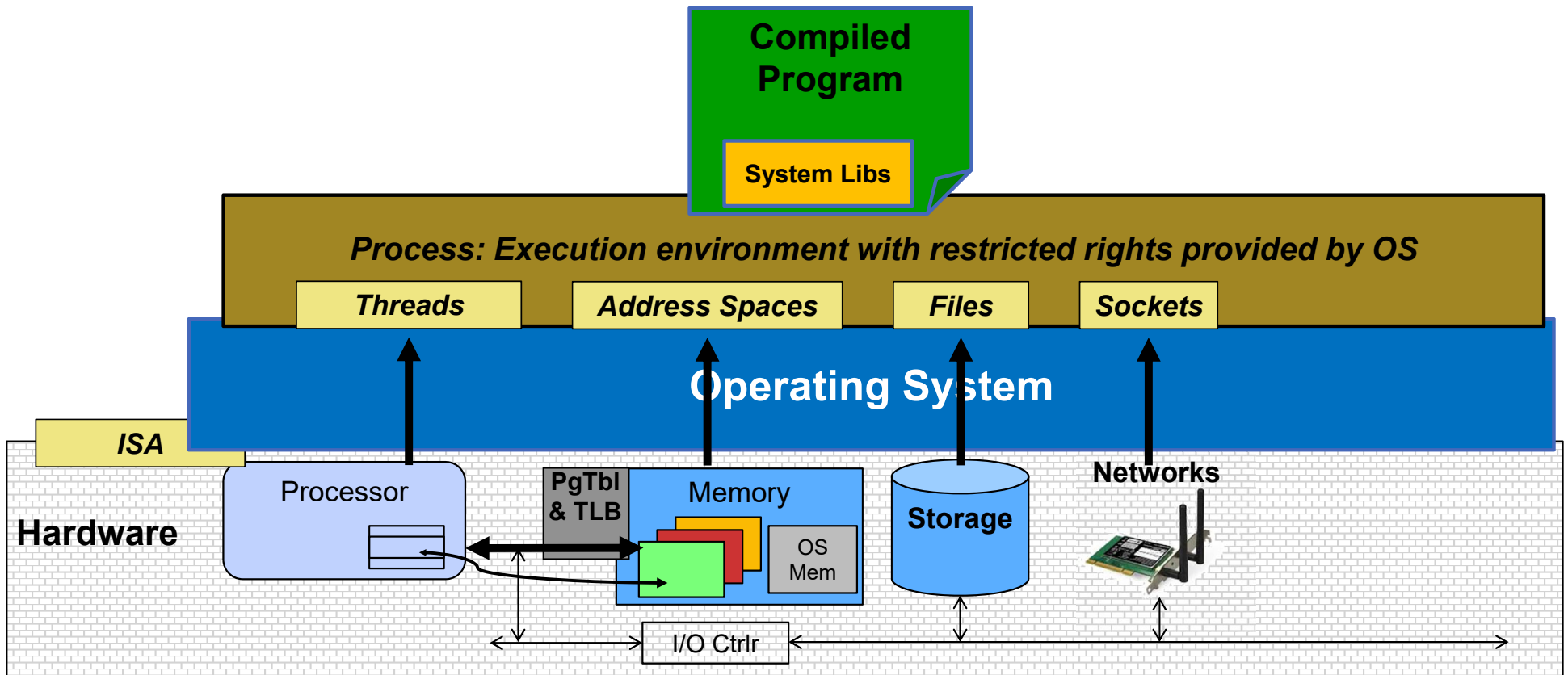



# Compiled Program's View of the World

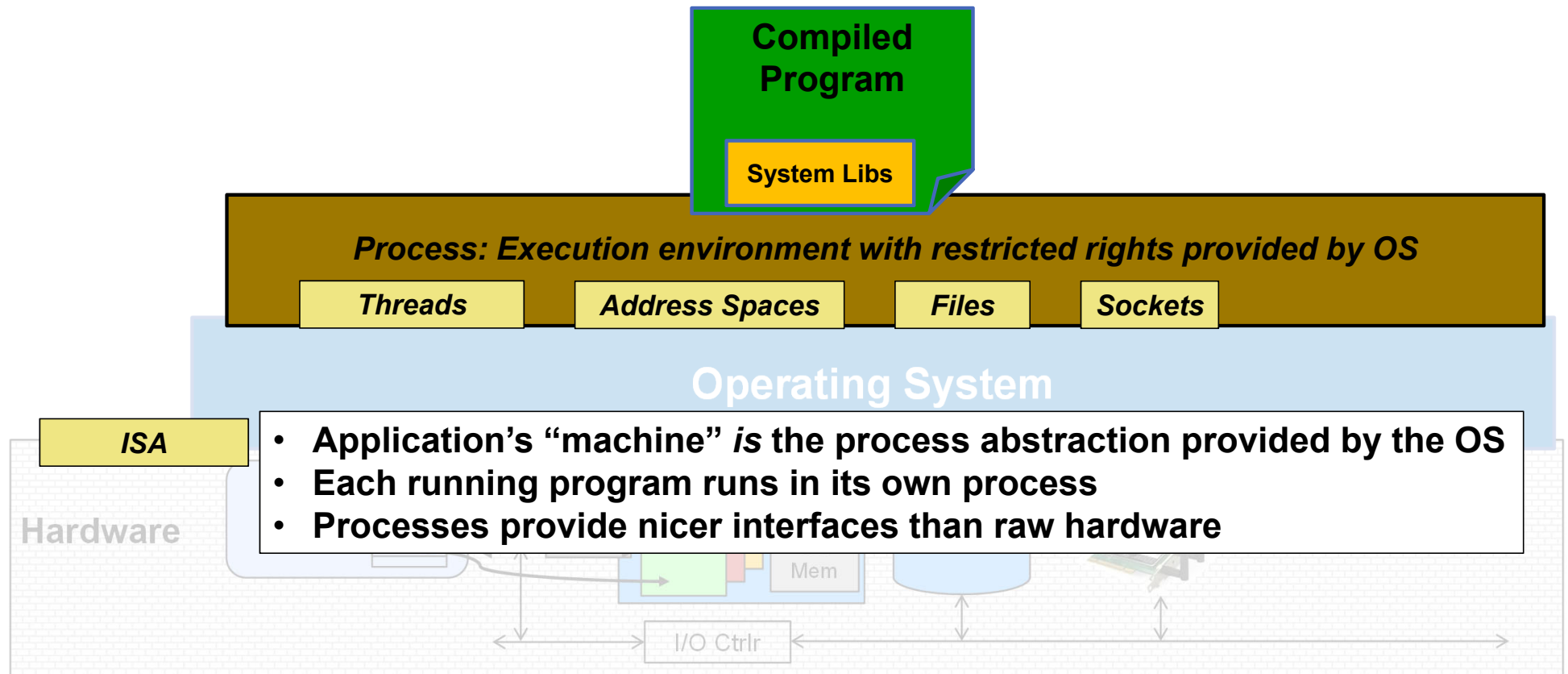

# System Programmer's View of the World

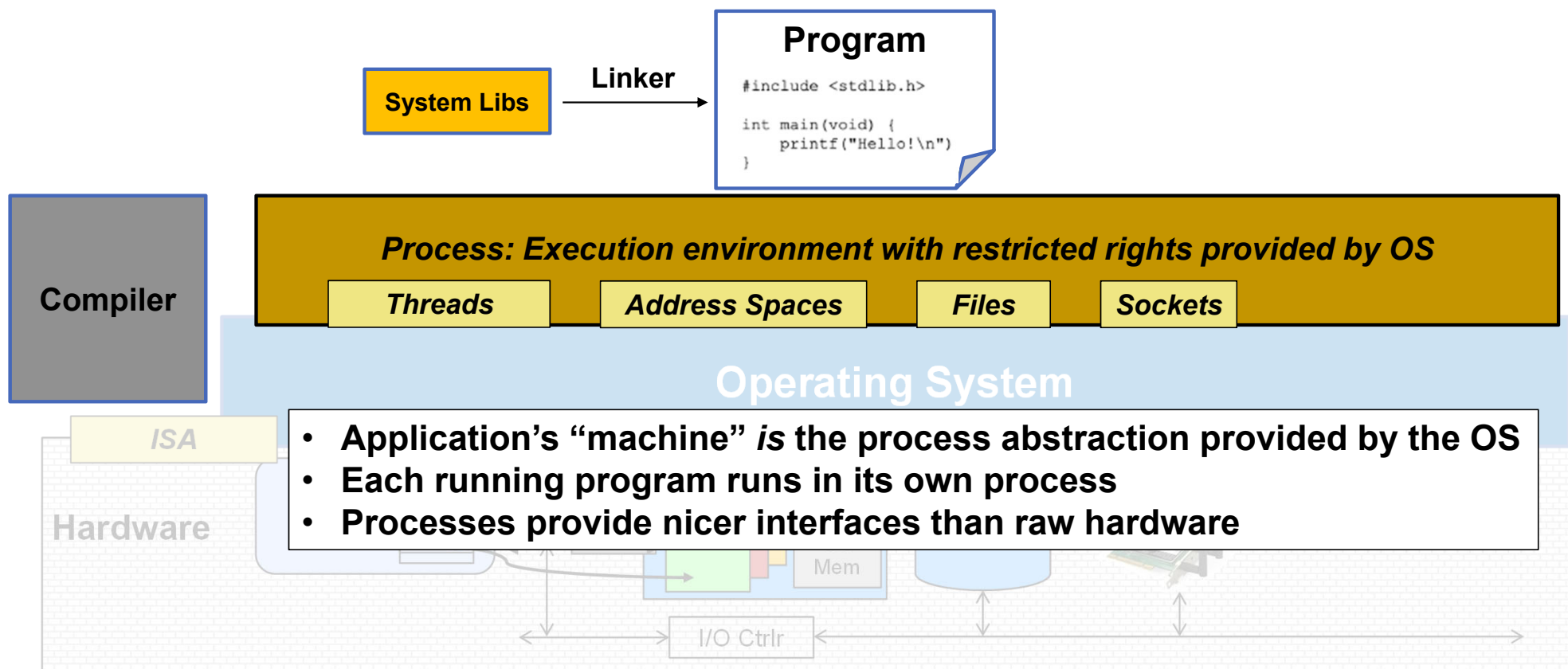

# What's in a Process?

---

## **A process consists of:**

- Address Space
- One or more threads of control executing in that address space
- Additional system state associated with it
  - Open files
  - Open sockets (network connections)
  - ...

For Example...

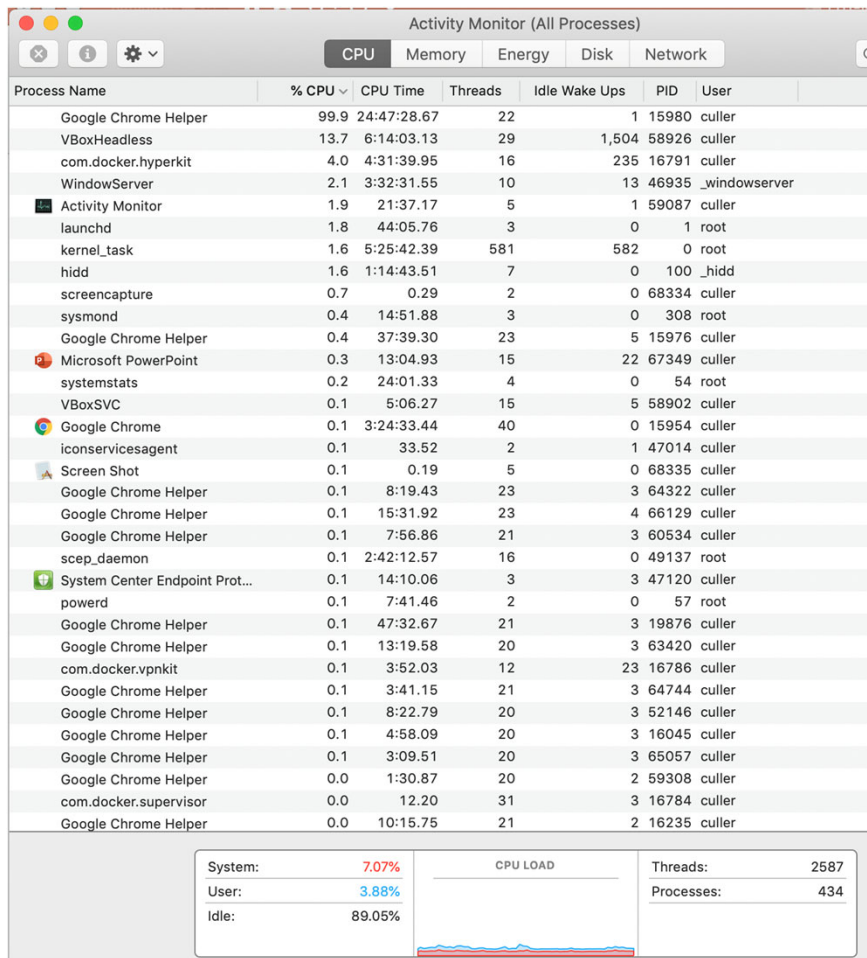

# Operating System's View of the World

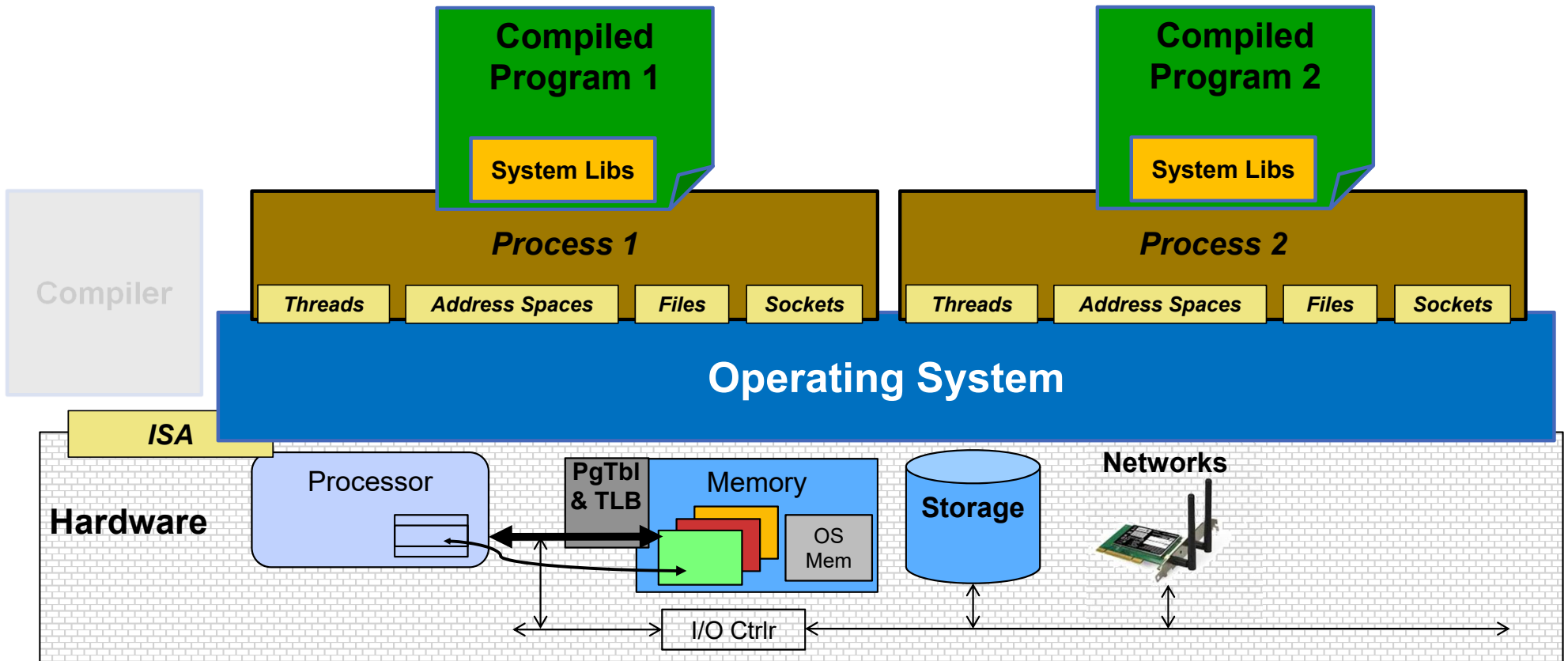



# Operating System's View of the World

- OS translates from hardware interface to application interface
- OS provides each running program with its own process

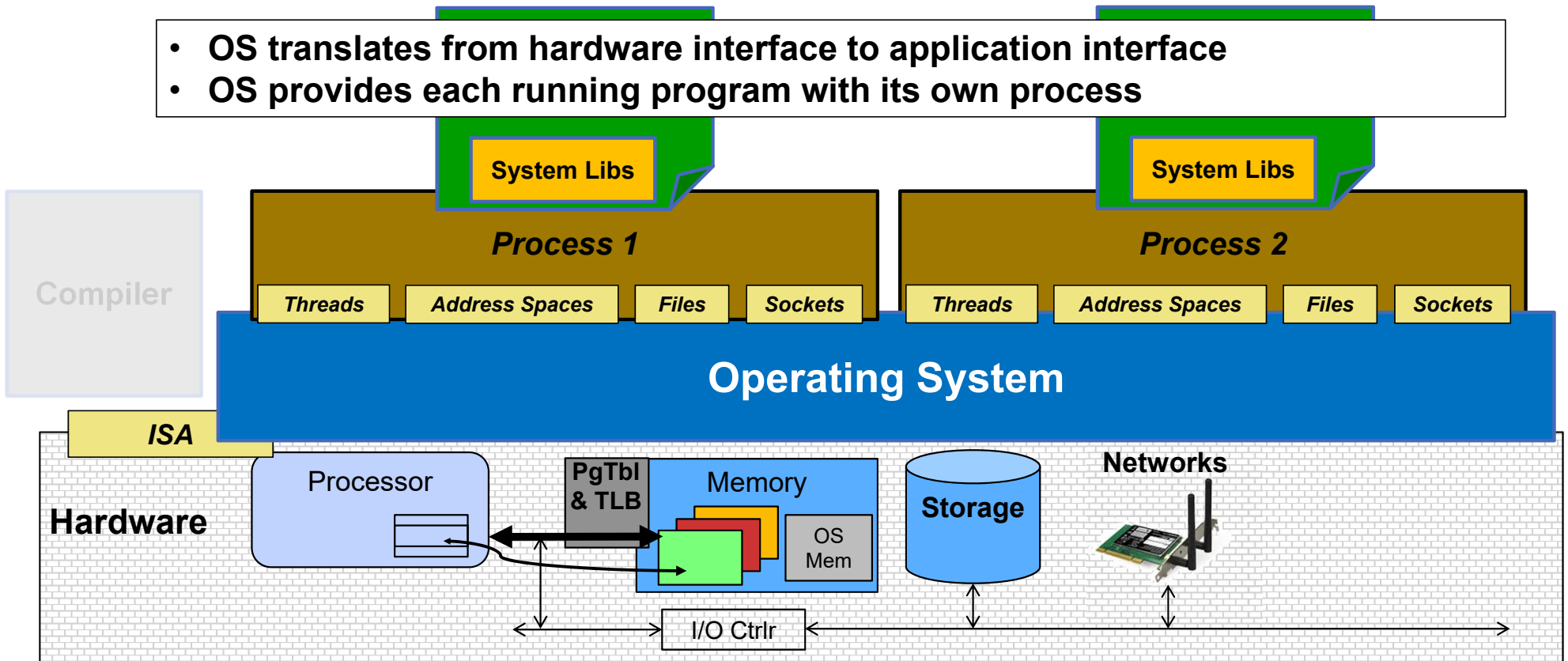

# What is an Operating System?

---



- Referee
  - Manage protection, isolation, and sharing of resources
    - » Resource allocation and communication
- Illusionist
  - Provide clean, easy-to-use abstractions of physical resources
    - » Infinite memory, dedicated machine
    - » Higher level objects: files, users, messages
    - » Masking limitations, virtualization



# OS Basics: Running a Process

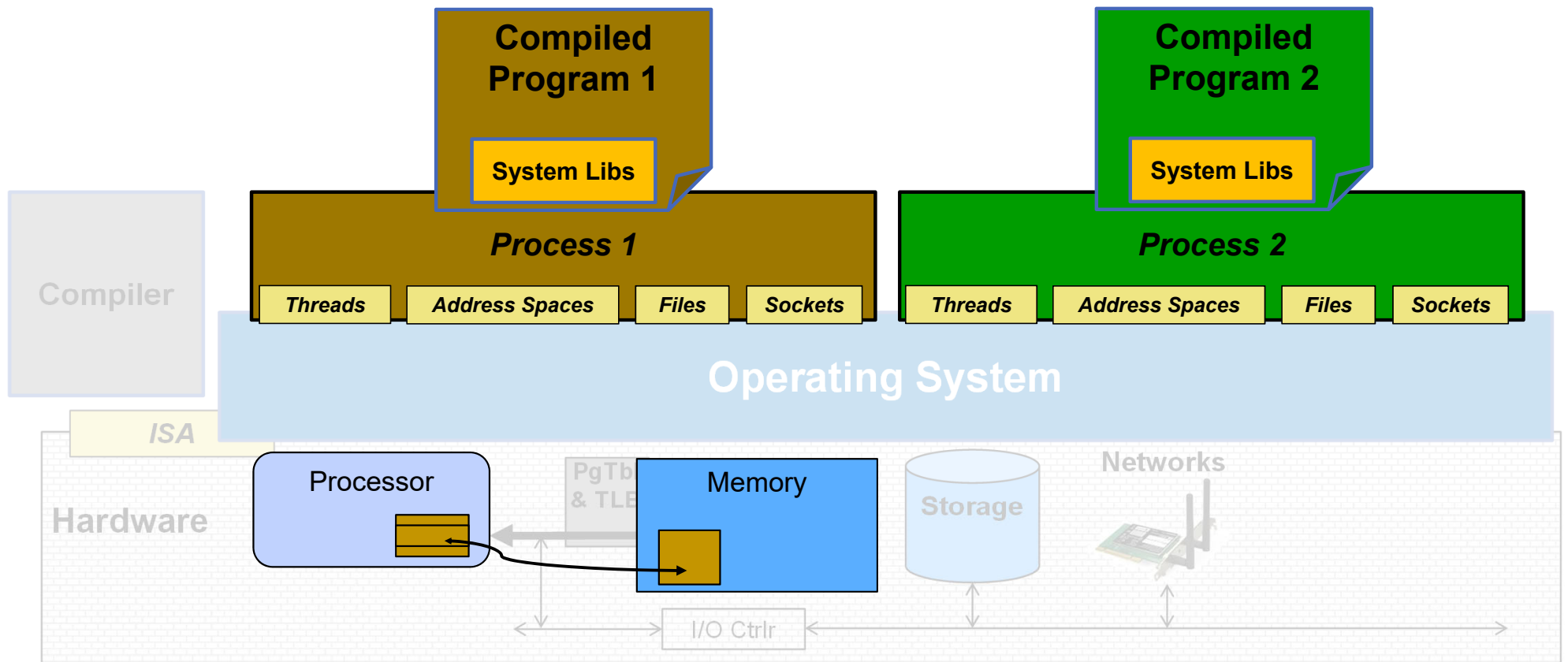

# OS Basics: Switching Processes

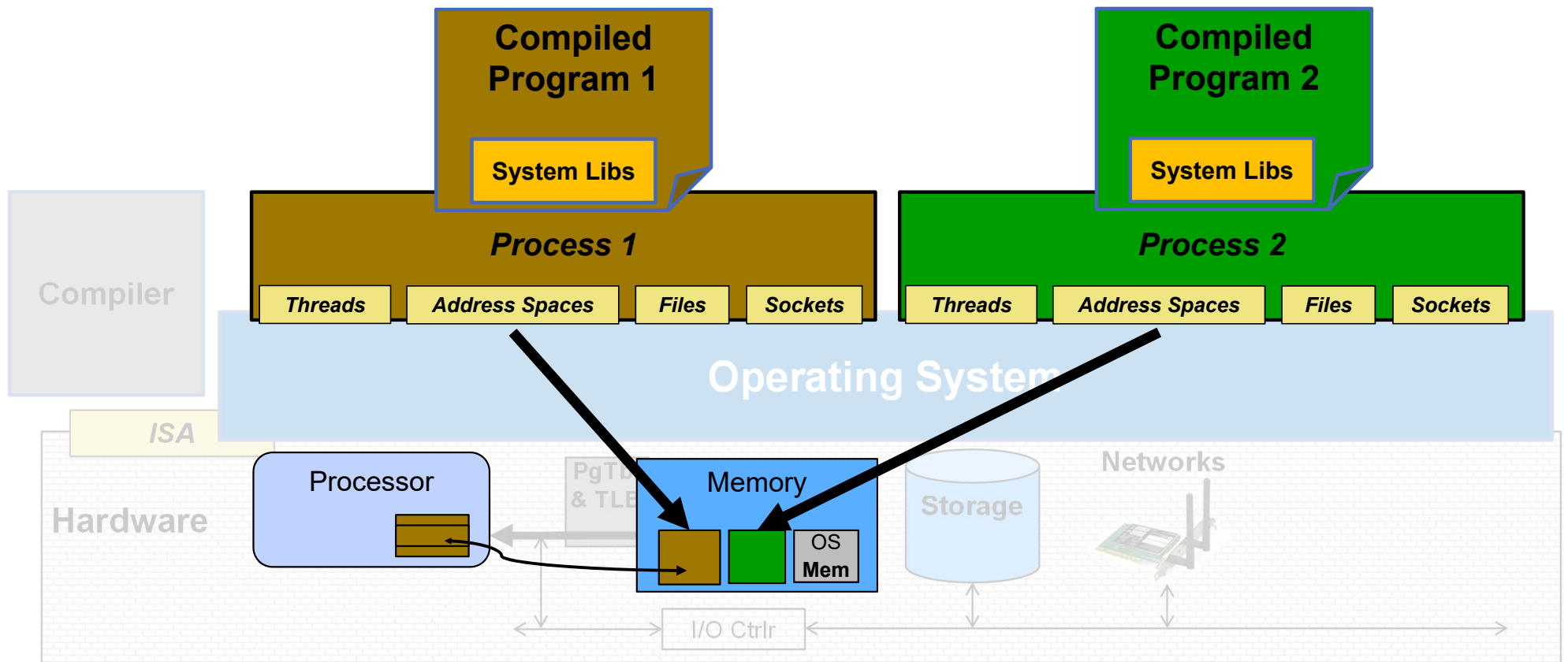

# OS Basics: Switching Processes

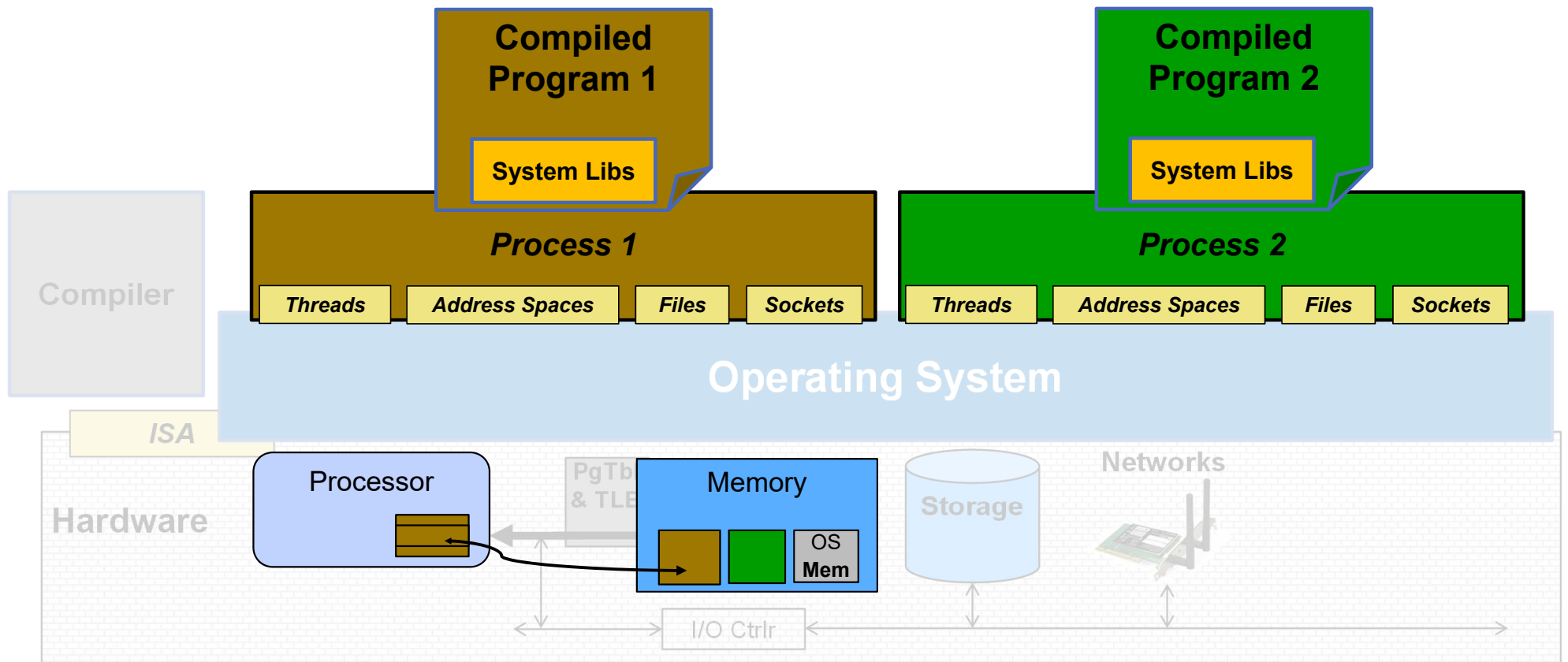

# OS Basics: Switching Processes

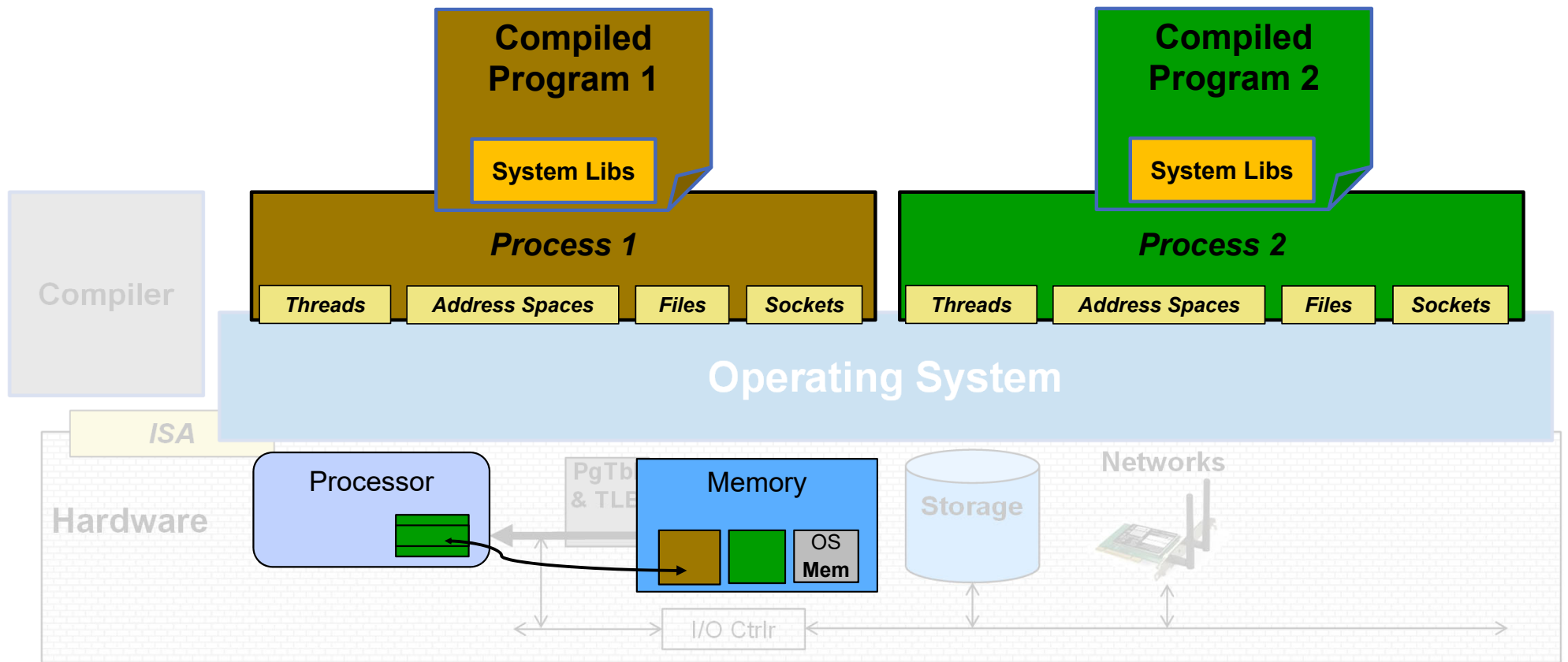

# OS Basics: Switching Processes

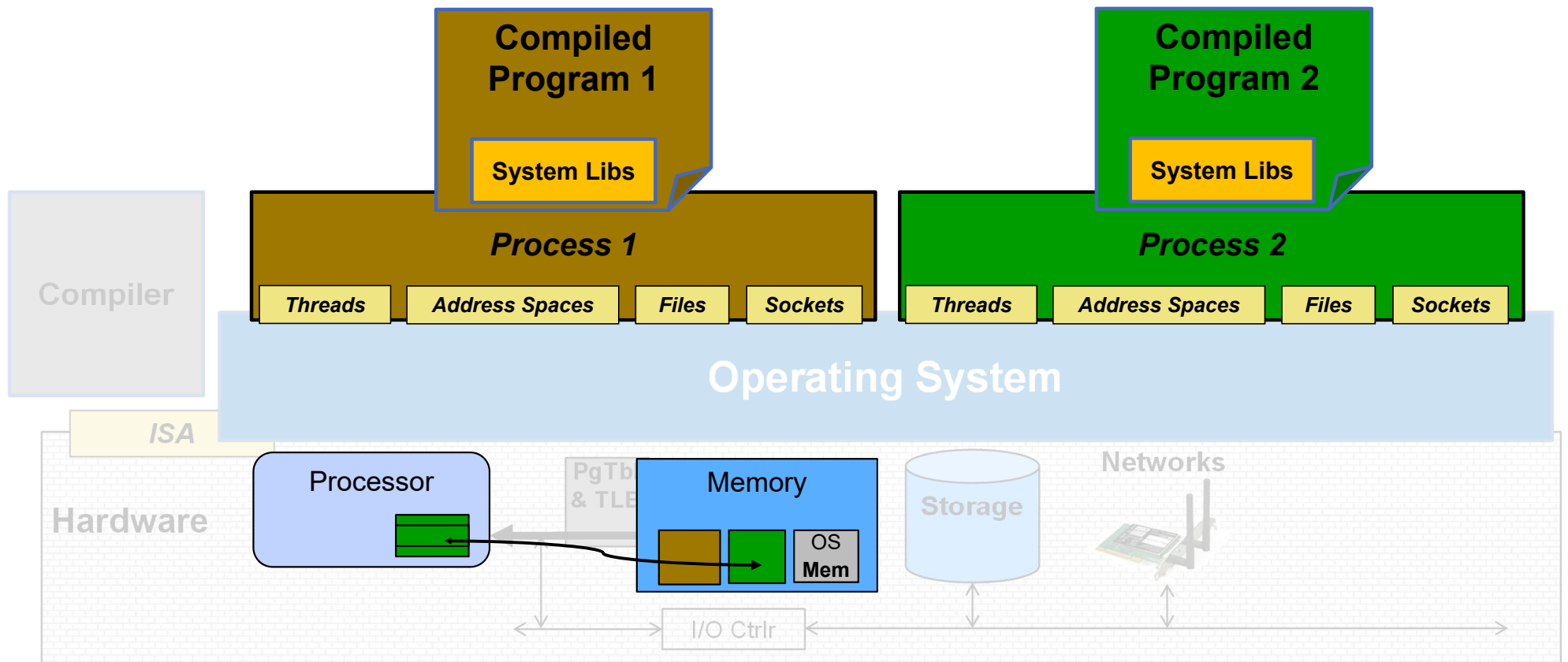

# OS Basics: Protection

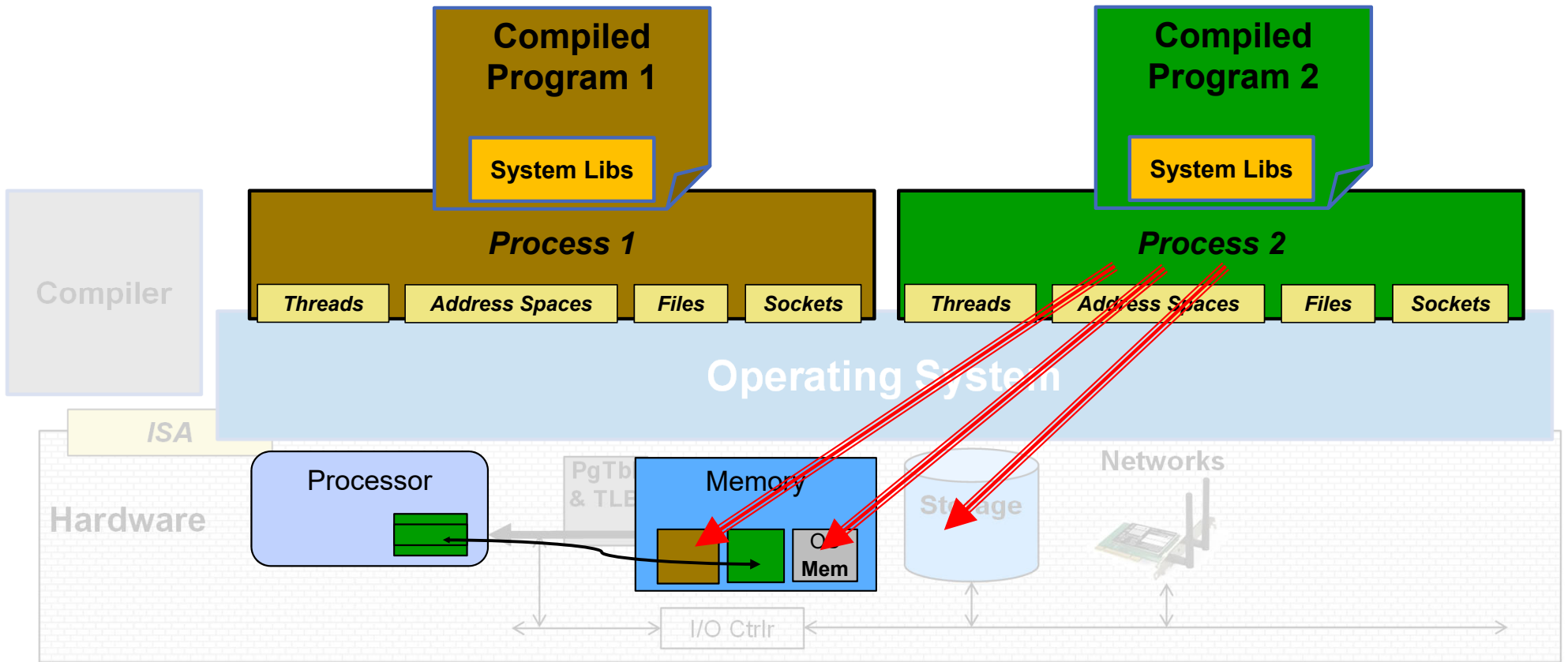



# OS Basics: Protection

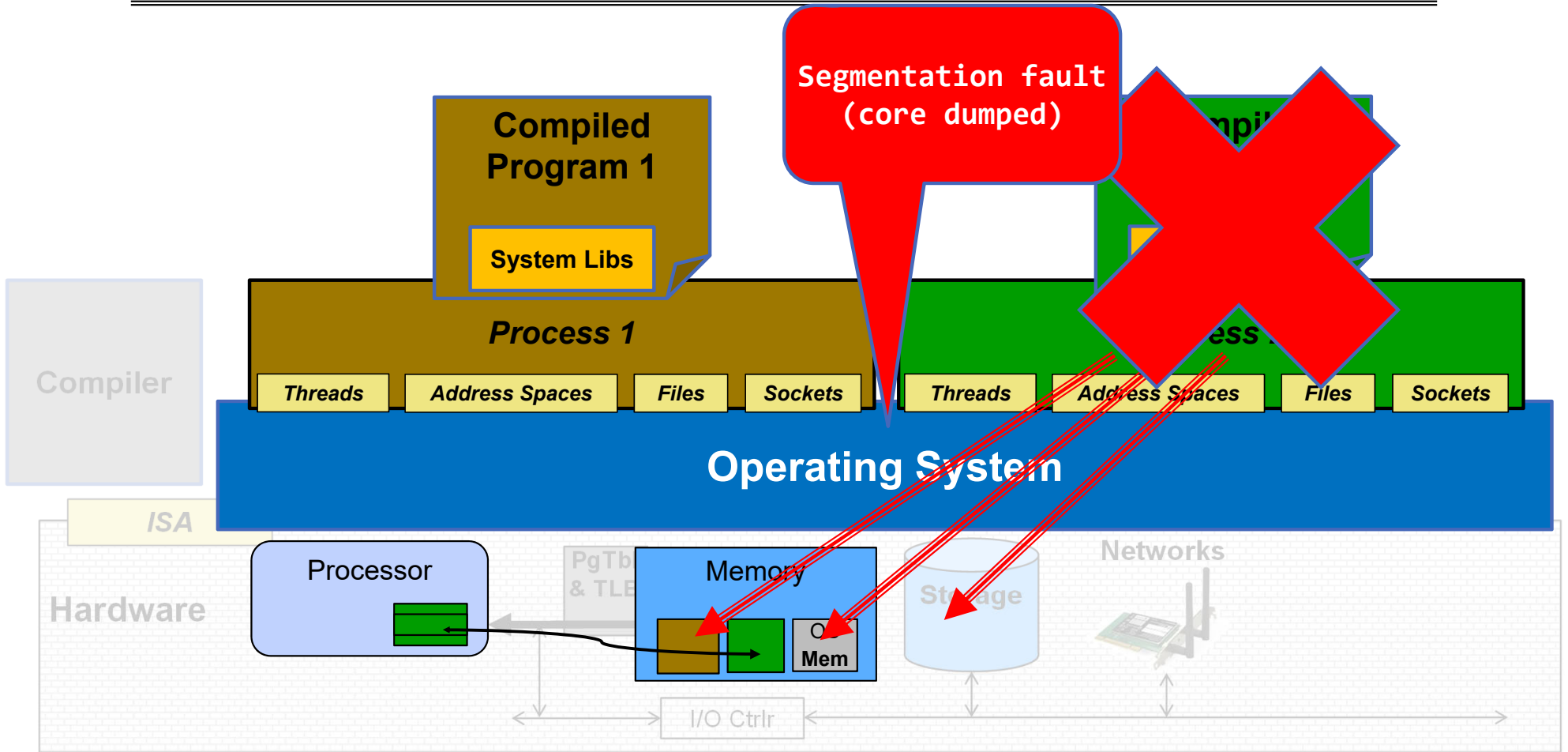

# OS Basics: Protection

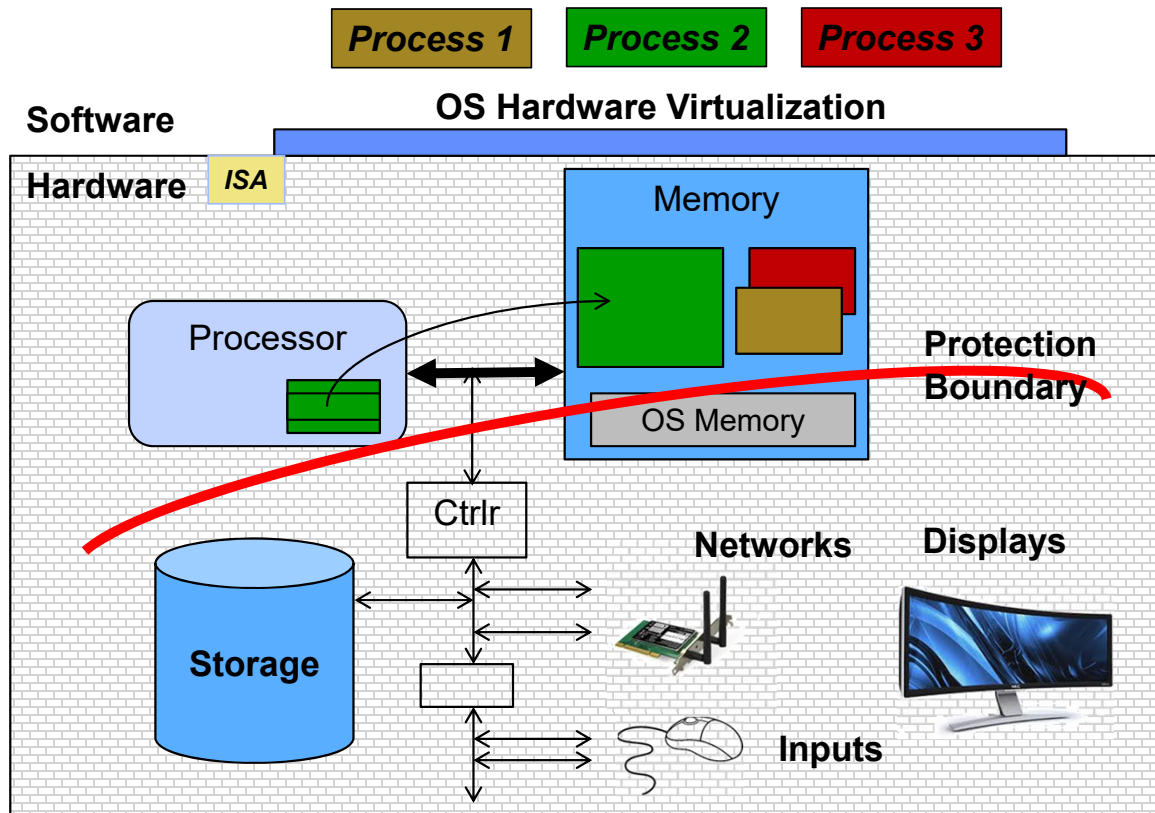

- **OS isolates processes from each other**
- **OS isolates itself from other processes**
- **... even though they are actually running on the same hardware!**

# What is an Operating System?

---



- Referee
  - Manage protection, isolation, and sharing of resources
    - » Resource allocation and communication



- Illusionist
  - Provide clean, easy-to-use abstractions of physical resources
    - » Infinite memory, dedicated machine
    - » Higher level objects: files, users, messages
    - » Masking limitations, virtualization



- Glue
  - Common services
    - » Storage, Window system, Networking
    - » Sharing, Authorization
    - » Look and feel

# OS Basics: I/O

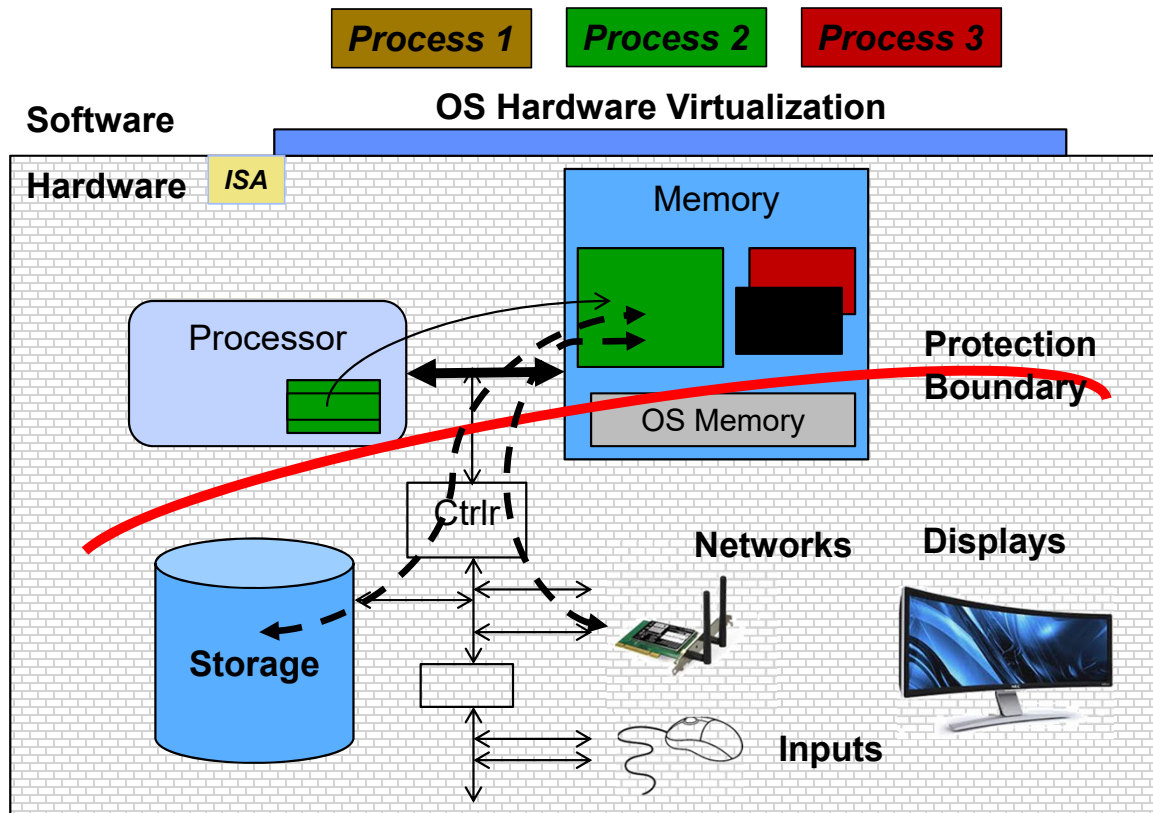

- **OS provides common services in the form of I/O**

# OS Basics: Look and Feel

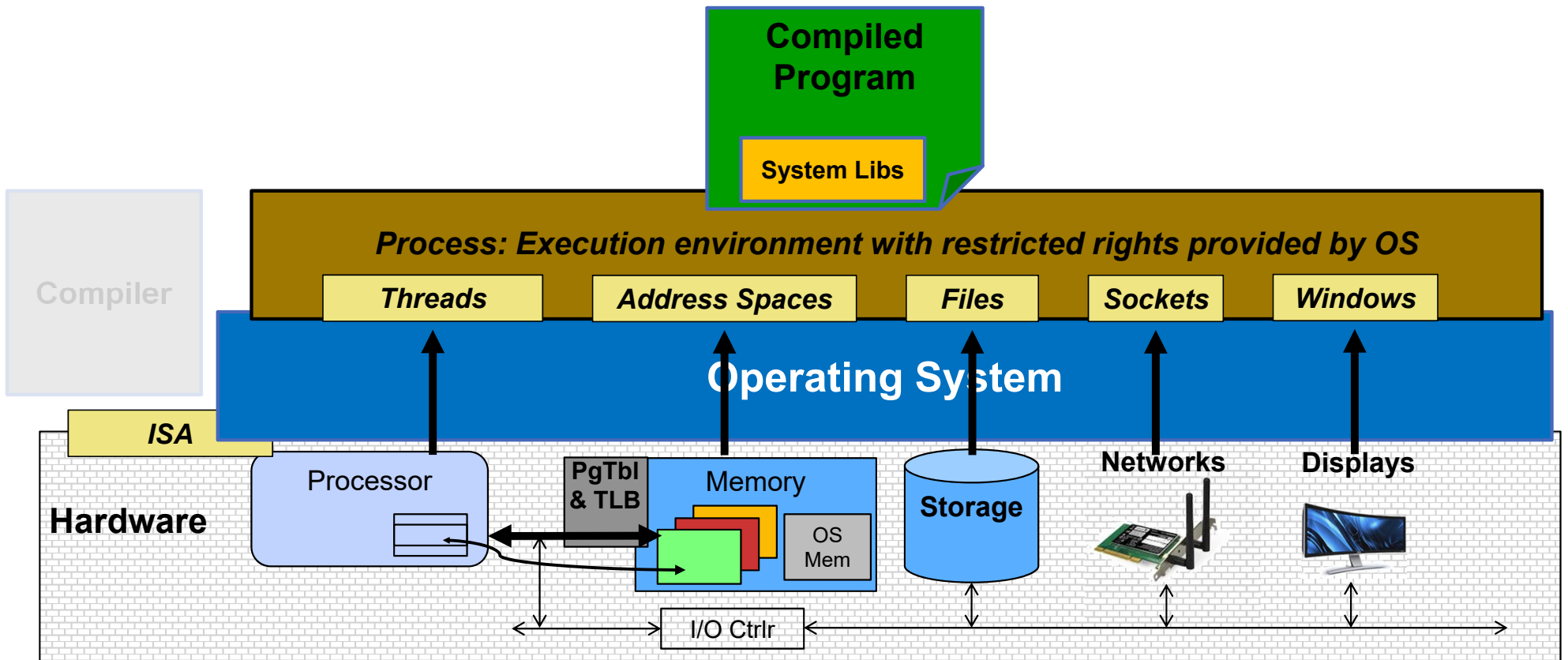

# OS Basics: Background Management

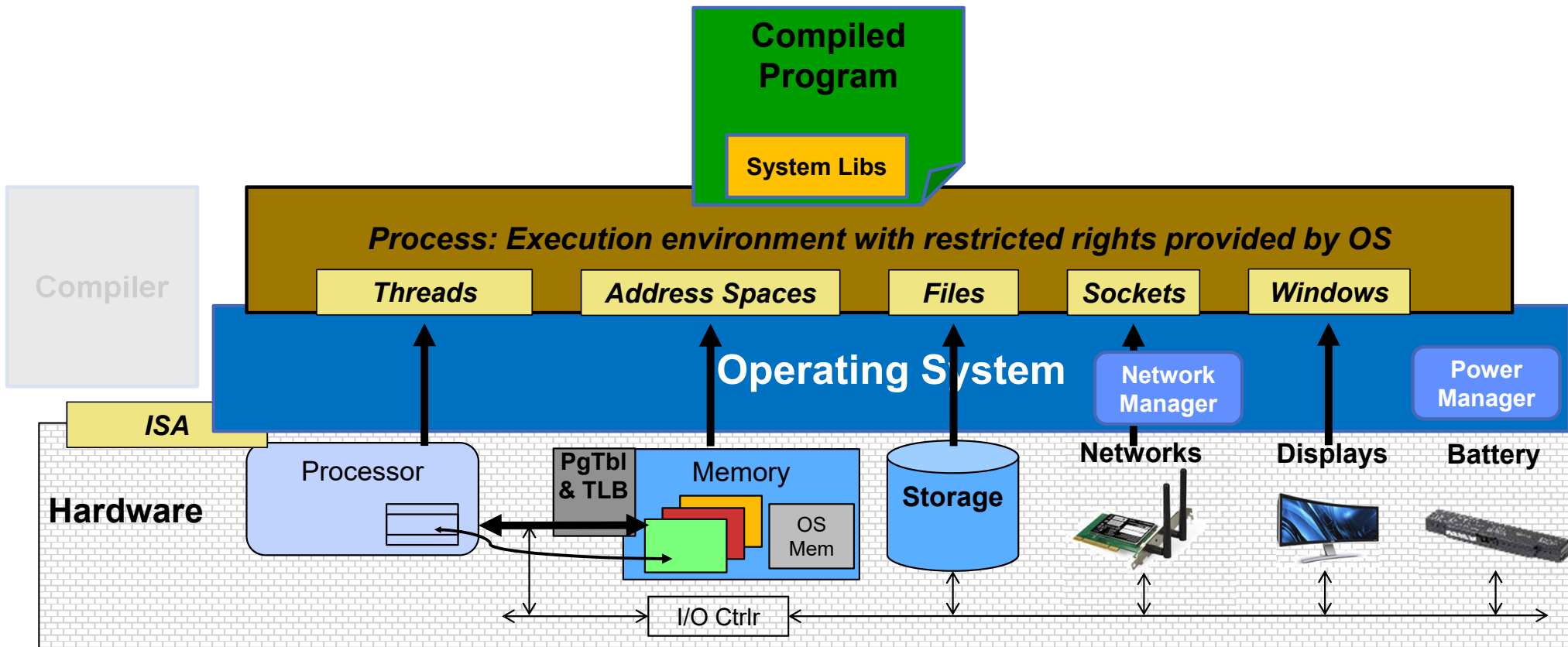

# What is an Operating System?

---



- Referee
  - Manage protection, isolation, and sharing of resources
    - » Resource allocation and communication



- Illusionist
  - Provide clean, easy-to-use abstractions of physical resources
    - » Infinite memory, dedicated machine
    - » Higher level objects: files, users, messages
    - » Masking limitations, virtualization

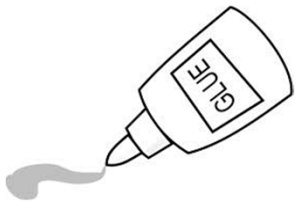

- Glue
  - Common services
    - » Storage, Window system, Networking
    - » Sharing, Authorization
    - » Look and feel

## Why take CS162?

---

- Some of you will actually design and build operating systems or components of them.
  - Perhaps more now than ever
- Many of you will create systems that utilize the core concepts in operating systems.
  - Whether you build software or hardware
  - The concepts and design patterns appear at many levels
- All of you will build applications, etc. that utilize operating systems
  - The better you understand their design and implementation, the better use you'll make of them.



# Who am I? John Kubiawicz (Prof “Kubi”)



John Kubiawicz  
(KUBI)

- Background in Hardware Design
  - Alewife project at MIT
  - Designed CMMU, Modified SPARC processor
  - Helped to write operating system
- Background in Operating Systems
  - Worked for Project Athena (MIT)
  - OS Developer (device drivers, network file systems)
  - Worked on Clustered High-Availability systems.
- Peer-to-Peer
  - OceanStore project – Store your data for 1000 years
  - Tapestry and Bamboo – Find you data around globe
  - One of the first cloud storage projects! (Before the cloud!)
- Quantum Computing
  - Exploring architectures for quantum computers
  - CAD tool set yields some interesting results
- **SwarmLAB/Berkeley Lab for Intelligent Edge**
  - **Global Data Plane (GDP)/DataCapsules**
  - **Fog Robotics**
  - **Hardened Data Containers**

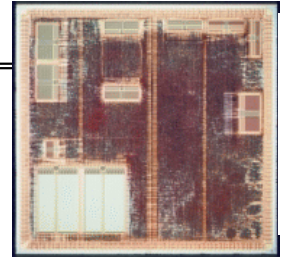

Alewife



Tessellation



OceanStore



Global Data  
Plane

# CS162 TAs: Sections TBA

---



David Zhang  
(Head-Head TA)



Rohan Kumar  
(Head TA)



Levy Deng



Vasanth Kumar



Wilson Nguyen



Viansa (Ansa)  
Schmulbach



Daniel Zhu

# Enrollment

---

- This term class size is extremely limited for funding reasons
  - We will be expanding the class a bit
    - » When this happens, we will let students in automatically
  - Please do not email us asking for special reordering of the waitlist!
    - » Ordering is dictated by department policy!
- This is an Early Drop Deadline course (January 27<sup>th</sup>)
  - If you are not serious about taking this class, *please drop quickly*
    - » Department will continue to admit students as other students drop
  - Really hard to drop afterwards!
    - » Don't forget to keep up with work if you are still on the waitlist!
- As long as you are on the waitlist or applying for concurrent enrollment, you must do the work!
  - If you are no longer interested in the course, please remove yourself from waitlist

# Infrastructure, Textbook & Readings

- Infrastructure
  - Website: <http://cs162.org>
  - EdStem: <https://edstem.org/us/courses/33980/>
  - Lecture Recordings: Tentatively as links off main class page (within one week?)
- Textbook: Operating Systems: Principles and Practice (2nd Edition) Anderson and Dahlin
  - Suggested readings posted along with lectures
  - Try to keep up with material in book as well as lectures
- Supplementary Material
  - Operating Systems: Three Easy Pieces, by Remzi and Andrea Arpaci-Dusseau, available for free online
  - Linux Kernel Development, 3<sup>rd</sup> edition, by Robert Love
- Online supplements
  - See course website
  - Includes Appendices, sample problems, etc.
  - Networking, Databases, Software Eng, Security
  - **Some Research Papers!**

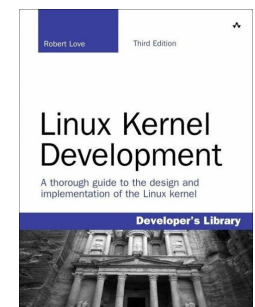
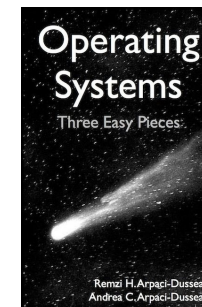
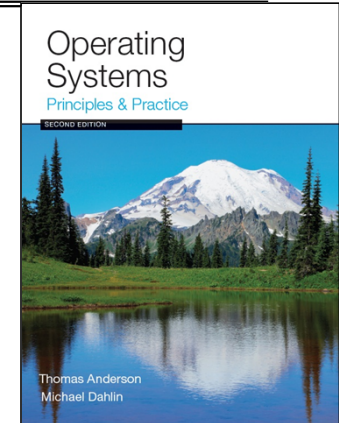

# Syllabus

---

- OS Concepts: How to Navigate as a Systems Programmer!
  - Process, I/O, Networks and Virtual Machines
- Concurrency
  - Threads, scheduling, locks, deadlock, scalability, fairness
- Address Space
  - Virtual memory, address translation, protection, sharing
- File Systems
  - I/O devices, file objects, storage, naming, caching, performance, paging, transactions, databases
- Distributed Systems
  - Protocols, N-Tiers, RPC, NFS, DHTs, Consistency, Scalability, multicast
- Reliability & Security
  - Fault tolerance, protection, security
- Cloud Infrastructure

# Learning by Doing

---

- Individual Homeworks (2-3 weeks) - preliminary
  - 0. Tools & Environment, Autograding, recall C, executable
  - 1. Lists in C
  - 2. BYOS – build your own shell
  - 3. Sockets & Threads in HTTP server
  - 4. Memory mapping and management
  - 5. Map Reduce
- Three (and ½) Group Projects
  - 0. Getting Started (Individual, before you have a group)
  - 1. User-programs (exec & syscall)
  - 2. Threads & Scheduling
  - 3. File Systems





# Group Projects

---

- Project teams have 4 members!
  - never 5, 3 requires serious justification
  - Must work in groups in “the real world”
  - **Same section (at least same TA)**
- Communication and cooperation will be essential
  - Regular in-person meetings very important!
  - Joint work on Design Documents
  - Slack/Messenger/whatever doesn't replace **face-to-face!**
- Everyone should do work and have clear responsibilities
  - You will evaluate your teammates at the end of each project
  - Dividing up by Task is the worst approach. Work as a team.
- Communicate with supervisor (TAs)
  - What is the team's plan?
  - What is each member's responsibility?
  - Short progress reports are required
  - **Design Documents: High-level description for a manager!**



## Getting started

---

- **EVERYONE (even if you are on the waitlist!):**  
Start homework 0 right away (hopefully Today!), project 0 next week
  - Github account
  - VM environment for the course
    - » Consistent, managed environment on your machine
  - Get familiar with all the cs162 tools
  - Submit to autograder via git
- First two weeks, attend any section you want
  - We'll assign permanent sections after forming project groups
  - Section attendance will be mandatory after we form groups
  - These section times will be adjusted after we have a better idea where people are



## Preparing Yourself for this Class

---

- The projects will require you to be very comfortable with programming and debugging C
  - Pointers (including function pointers, void\*)
  - Memory Management (malloc, free, stack vs heap)
  - Debugging with GDB
- You will be working on a larger, more sophisticated code base than anything you've likely seen in 61C!
- **Review Session on the C language**
  - **Time and logistics TBA, but soon!**
- "Resources" page on course website
  - Ebooks on "git" and "C"
- C programming reference (still in beta):
  - <https://cs162.org/ladder/>
- First two sections are also dedicated to programming and debugging review:
  - Attend ANY sections in first two weeks

## Grading (Tentative breakdown)

---

- 36% three midterms (12% each)
  - Thursday, 2/16 (7-9pm), No class on day of Midterm (extra OH)
  - Wednesday, 3/15 (8-10pm)
  - Thursday, 4/27 (7-9pm), No class on day of Midterm (extra OH)
  - These will be IN-PERSON!
- 36% projects
- 18% homework
- 10% participation (Sections, Lecture, ...)
- *No final exam*
- Projects
  - Initial design document, Design review, Code, Final design
  - Submission via *git push* triggers autograder

---

## Personal Integrity

- UCB Academic Honor Code: "As a member of the UC Berkeley community, I act with honesty, integrity, and respect for others."

<http://asuc.org/honorcode/resources/HC%20Guide%20for%20Syllabi.pdf>

# CS 162 Collaboration Policy

---



- Explaining a concept to someone in another group
- Discussing algorithms/testing strategies with other groups
- Discussing debugging approaches with other groups
- Searching online for generic algorithms (e.g., hash table)



- Sharing code or test cases with another group
- Copying OR reading another group's code or test cases
- Copying OR reading online code or test cases from prior years
- Helping someone in another group to debug their code

- We compare all project submissions against prior year submissions and online solutions and will take actions (described on the course overview page) against offenders
- Don't put a friend in a bad position by asking for help that they shouldn't give!

# Typical Lecture Format

---

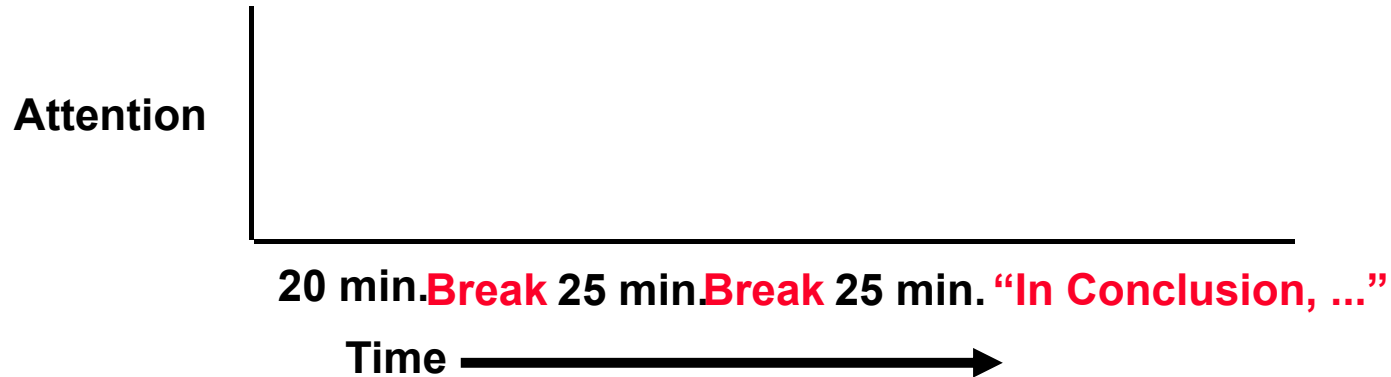

- 1-Minute Review
- 20-Minute Lecture
- 5- Minute Administrative Matters
- 25-Minute Lecture
- 5-Minute Break (water, stretch)
- 25-Minute Lecture

## Lecture Goal

---

**Interactive!!!**  
**Ask Questions in Chat**

---

# What makes Operating Systems Exciting and Challenging?

# Societal Scale Information Systems (Or the “Internet of Things”?)

- The world is a large distributed system
  - Microprocessors in everything
  - Vast infrastructure behind them

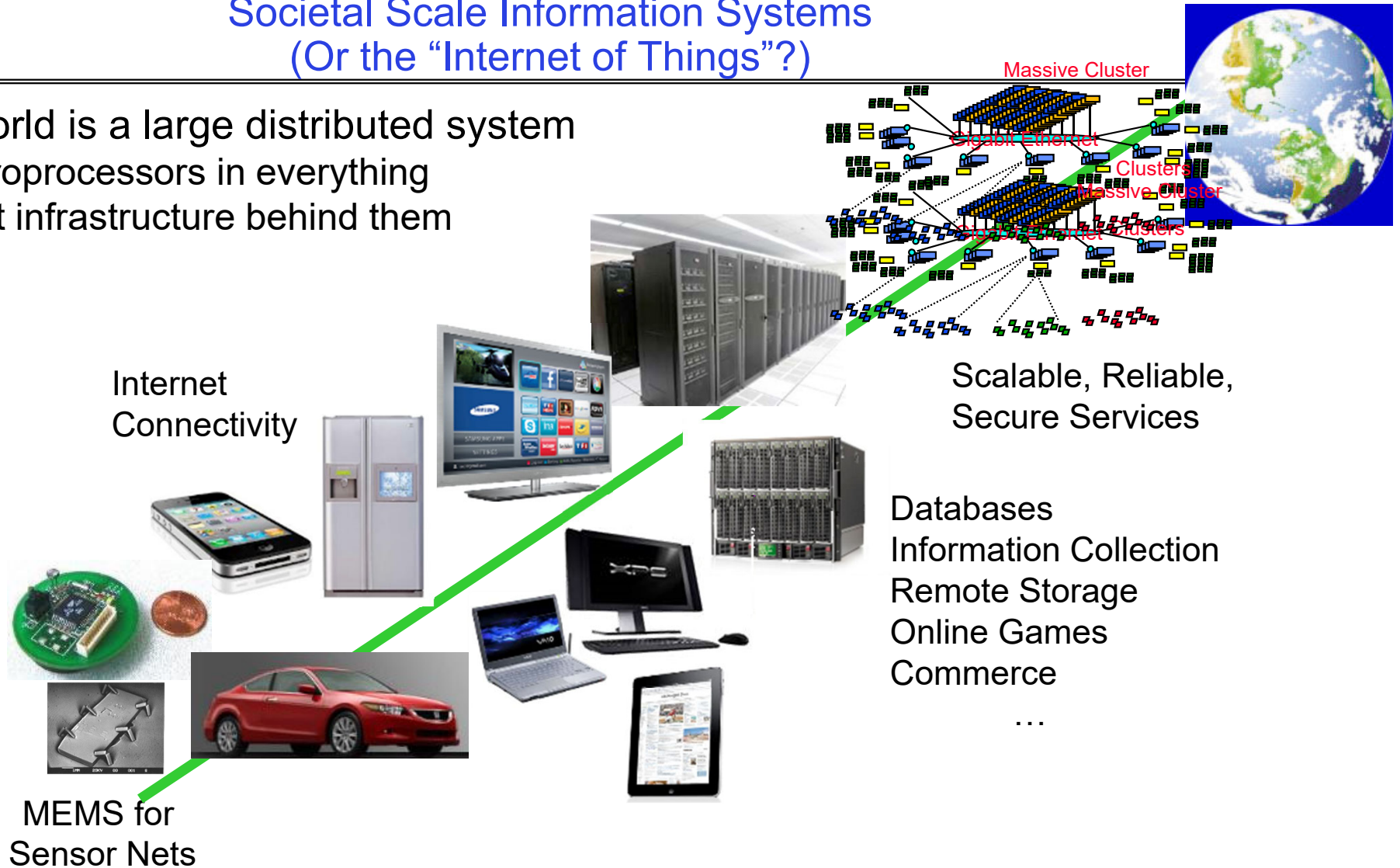



# Technology Trends: Moore's Law

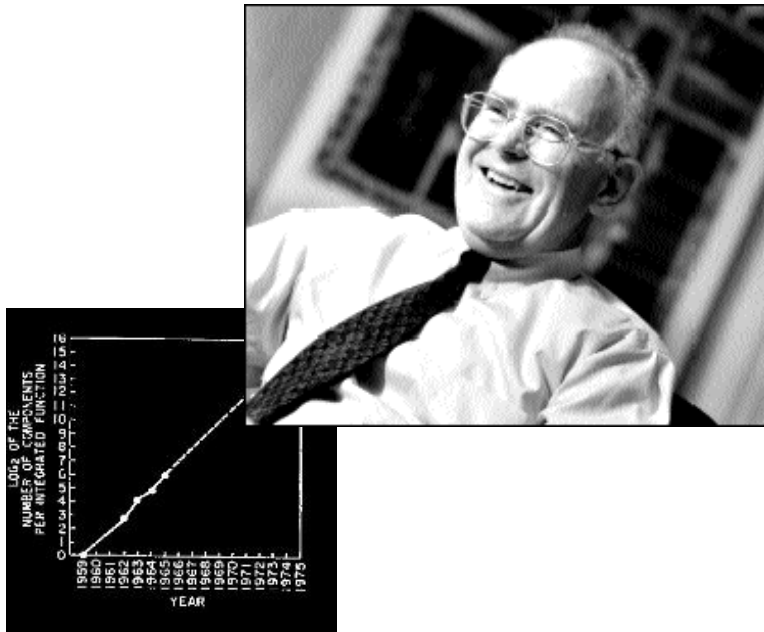

Gordon Moore (co-founder of Intel) predicted in 1965 that the transistor density of semiconductor chips would double roughly every 18 months

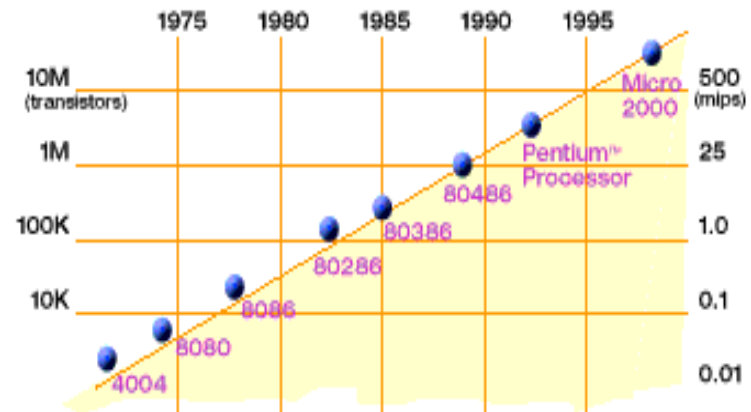

2X transistors/Chip Every 1.5 years  
Called "Moore's Law"

Microprocessors have become smaller, denser, and more powerful

# Big Challenge: Slowdown in Joy's law of Performance

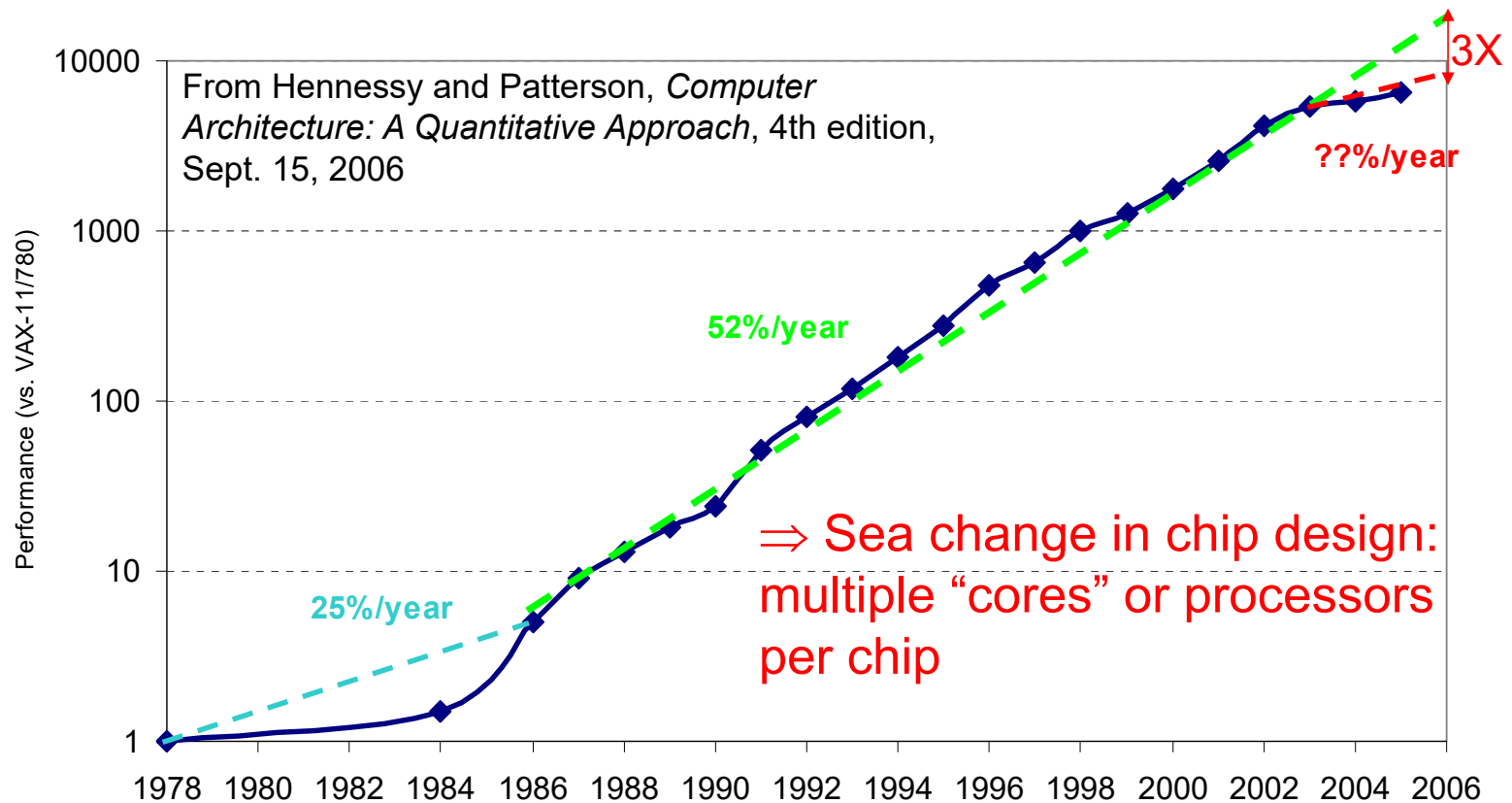

- VAX : 25%/year 1978 to 1986
- RISC + x86 : 52%/year 1986 to 2002
- RISC + x86 : ??%/year 2002 to present

# Another Challenge: Power Density

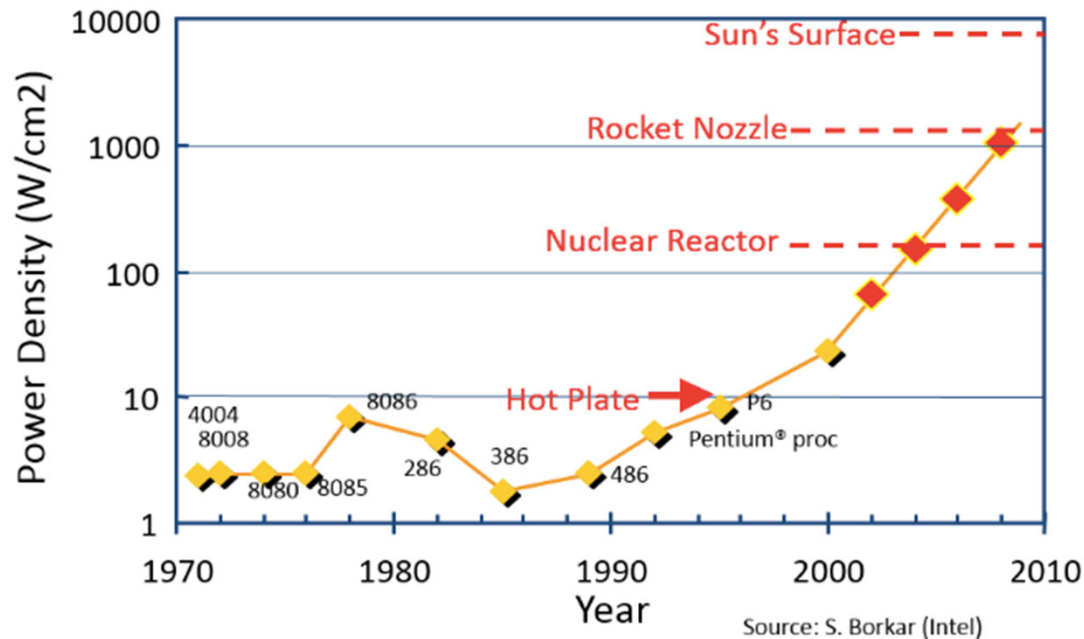

- Moore's law extrapolation
  - Potential power density reaching amazing levels!
- Flip side: battery life very important
  - Moore's law yielded more functionality at equivalent (or less) total energy consumption

# ManyCore Chips: The future arrived in 2007

- Intel 80-core multicore chip (Feb 2007)

- 80 simple cores
- Two FP-engines / core
- Mesh-like network
- 100 million transistors
- 65nm feature size

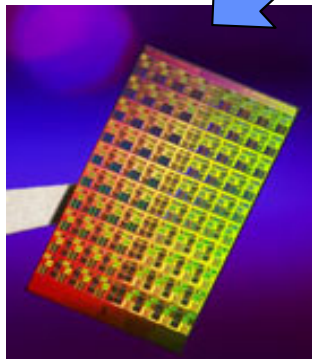

- Intel Single-Chip Cloud Computer (August 2010)

- 24 “tiles” with two cores/tile
- 24-router mesh network
- 4 DDR3 memory controllers
- Hardware support for message-passing

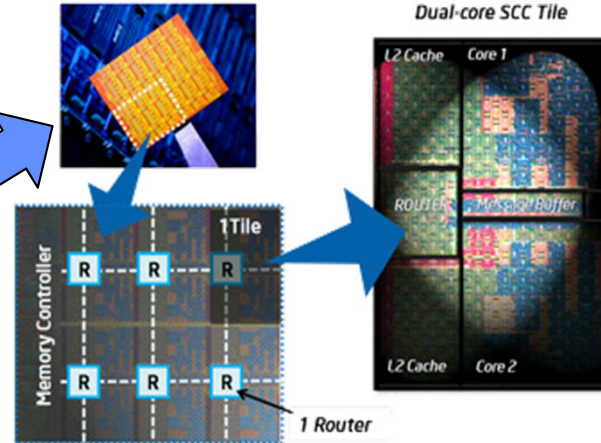

- How to program these?
  - Use 2 CPUs for video/audio
  - Use 1 for word processor, 1 for browser
  - 76 for virus checking???
- **Parallelism must be exploited at all levels**
- Amazon X1 instances (2016)
  - 128 virtual cores, 2 TB RAM

## But then Moore's Law Ended...

---

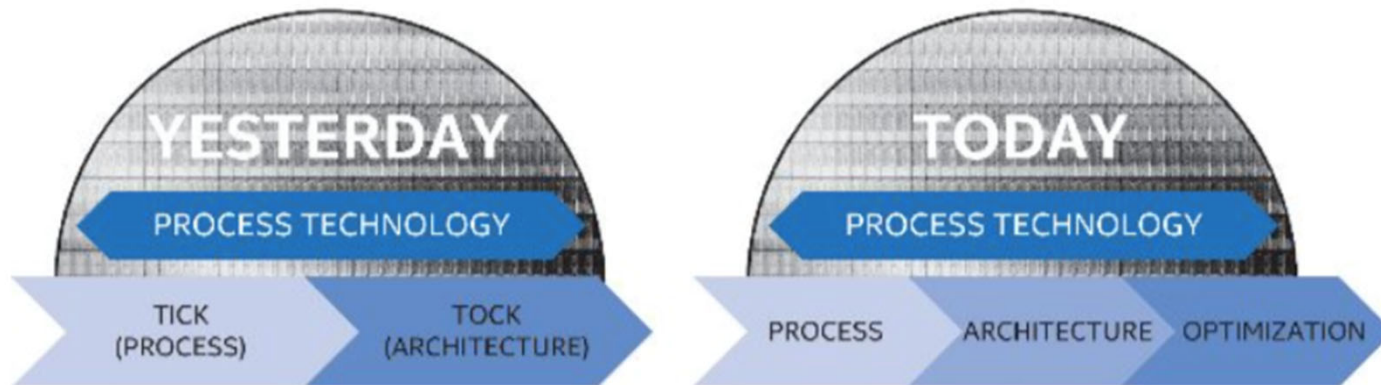

- Moore's Law has (officially) ended -- Feb 2016
  - No longer getting 2 x transistors/chip every 18 months...
  - or even every 24 months
- May have only 2-3 smallest geometry fabrication plants left:
  - Intel and Samsung and/or TSMC
- Vendors moving to 3D stacked chips
  - More layers in old geometries

# Storage Capacity is Still Growing!

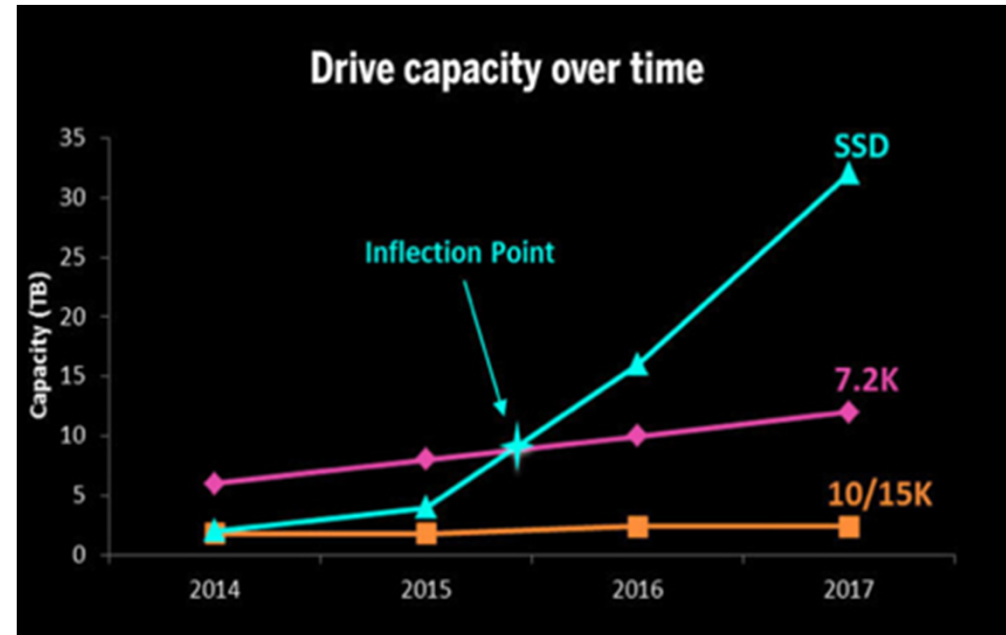
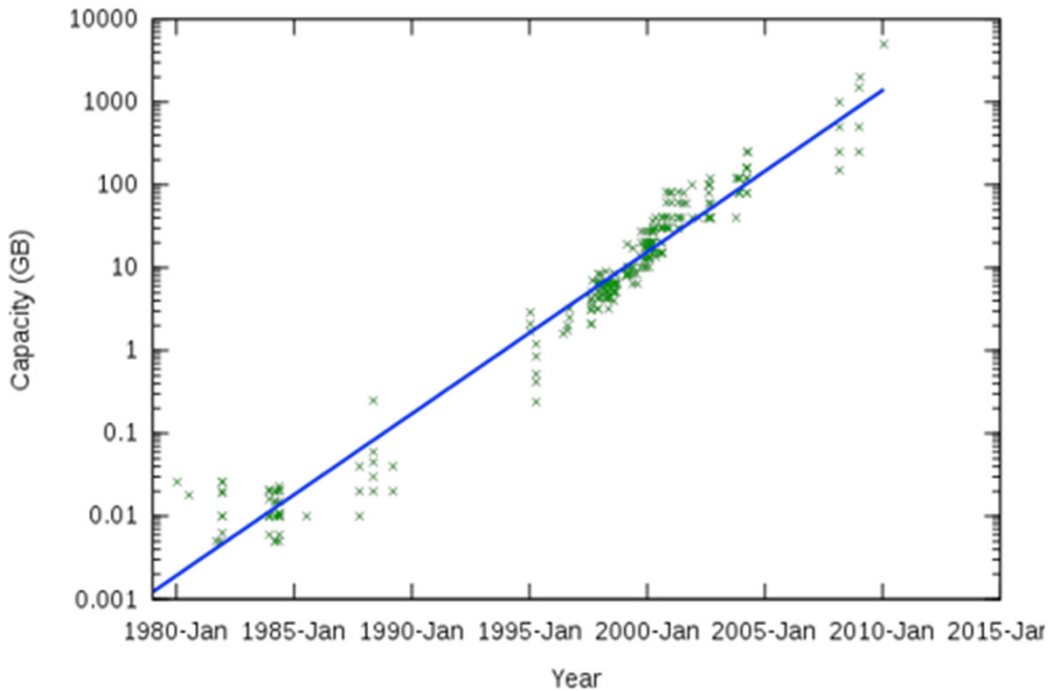

# Society is Increasingly Connected...

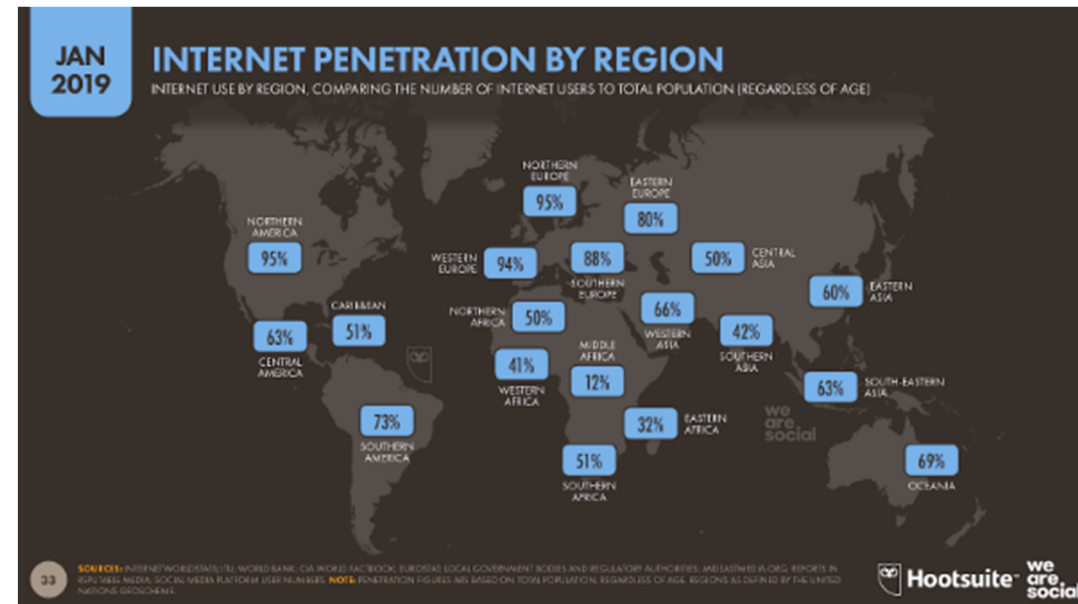

# Network Capacity Still Increasing

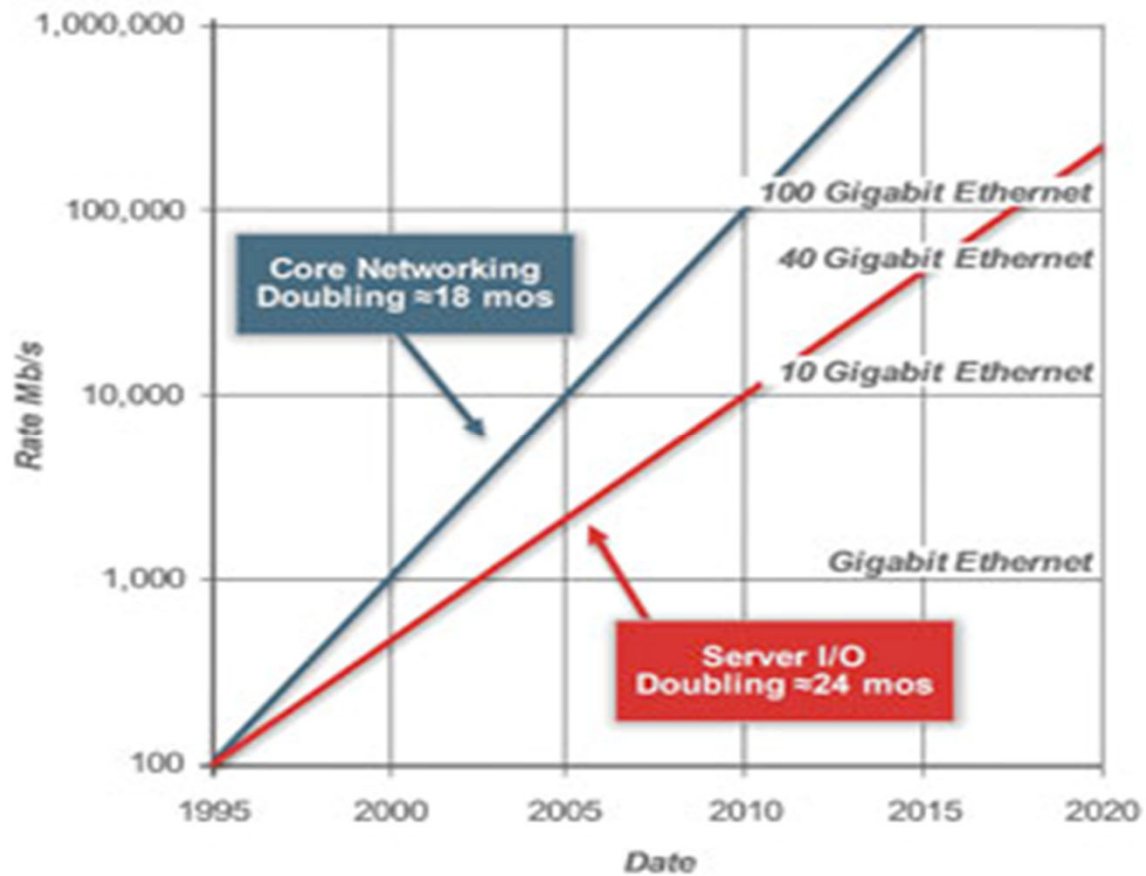

(source: <http://www.ospmag.com/issue/article/Time-Is-Not-Always-On-Our-Side> )



## Not Only PCs connected to the Internet

---

- In 2011, smartphone shipments exceeded PC shipments!

- 2011 shipments:

- 487M smartphones

- 414M PC clients

- » 210M notebooks

- » 112M desktops

- » 63M tablets

- 25M smart TVs

1.53B in 2017

262.5M in 2017

164M in 2017

39.5M in 2017



- 4 billion phones in the world → smartphones over next few years
- Then...

# People-to-Computer Ratio Over Time

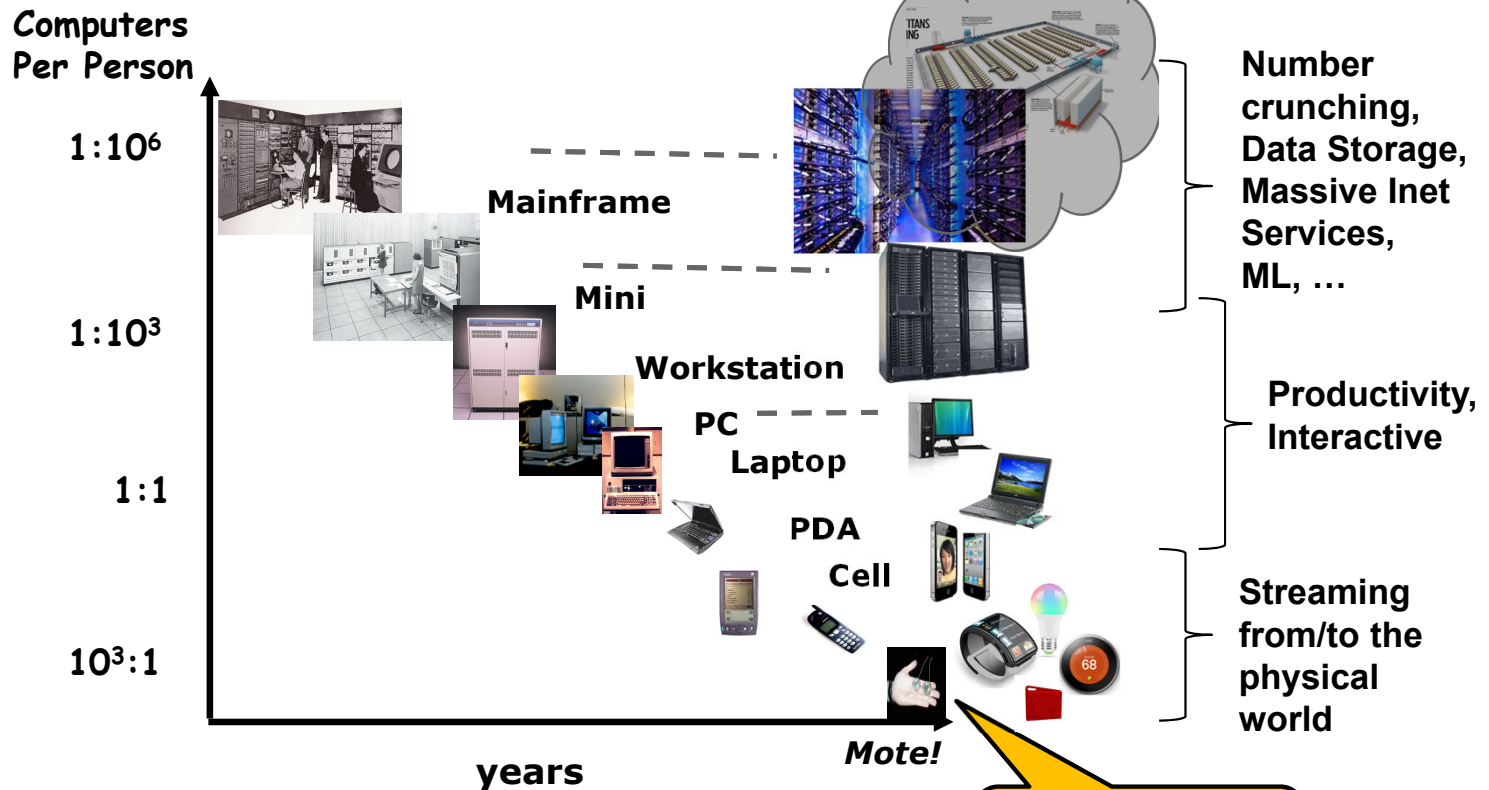

Bell's Law: new computer class per 10 years

The Internet of Things!

# What is an Operating System Again?

---



- Referee
  - Manage sharing of resources, Protection, Isolation
    - » Resource allocation, isolation, communication



- Illusionist
  - Provide clean, easy to use abstractions of physical resources
    - » Infinite memory, dedicated machine
    - » Higher level objects: files, users, messages
    - » Masking limitations, virtualization

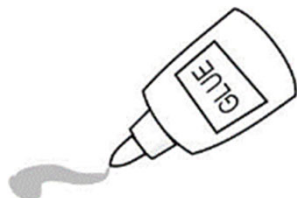

## Glue

- Common services
  - » Storage, Window system, Networking
  - » Sharing, Authorization
  - » Look and feel

# Challenge: Complexity

---

- Applications consisting of...
  - ... a variety of software modules that ...
  - ... run on a variety of devices (machines) that
    - » ... implement different hardware architectures
    - » ... run competing applications
    - » ... fail in unexpected ways
    - » ... can be under a variety of attacks
- Not feasible to test software for all possible environments and combinations of components and devices
  - The question is not whether there are bugs but how serious are the bugs!

# The World Is Parallel: Intel SkyLake (2017)

- Up to 28 Cores, 56 Threads
  - 694 mm<sup>2</sup> die size (estimated)
- Many different instructions
  - Security, Graphics
- Caches on chip:
  - L2: 28 MiB
  - Shared L3: 38.5 MiB (non-inclusive)
  - Directory-based cache coherence
- Network:
  - On-chip Mesh Interconnect
  - Fast off-chip network directly supports 8-chips connected
- DRAM/chips
  - Up to 1.5 TiB
  - DDR4 memory

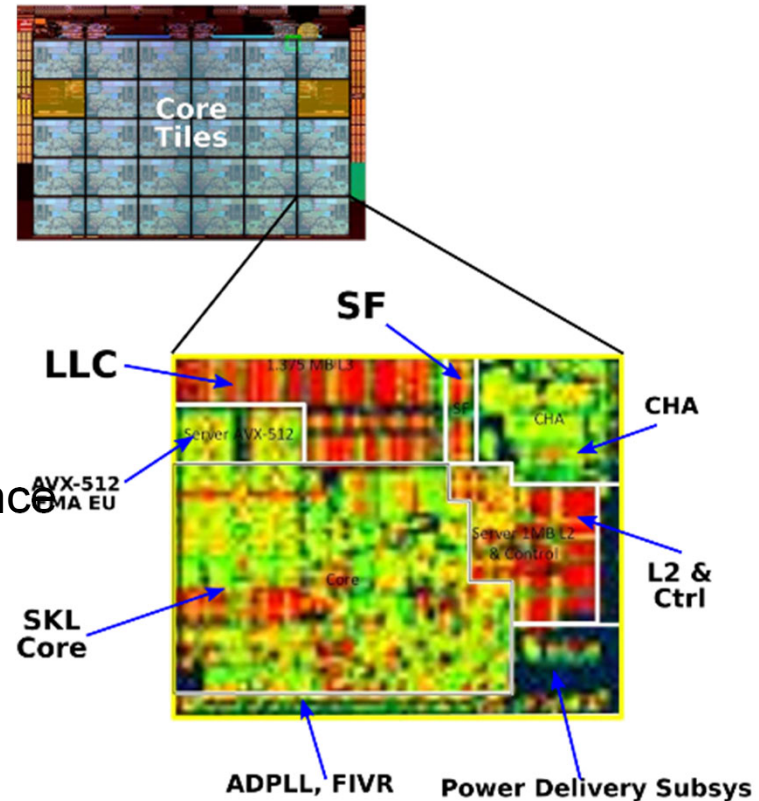

# HW Functionality comes with great complexity!

## Intel Skylake-X I/O Configuration

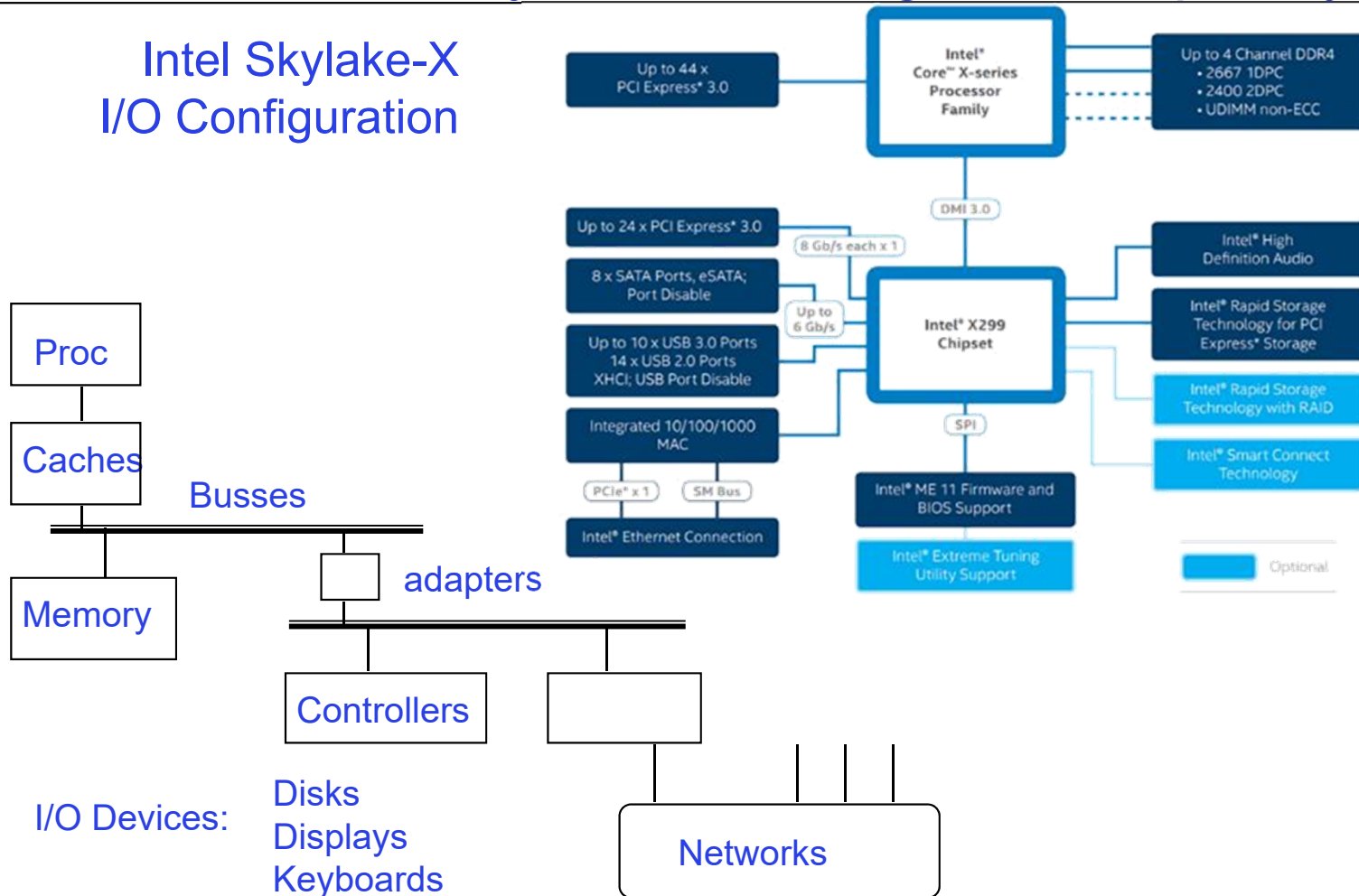

# Increasing Software Complexity

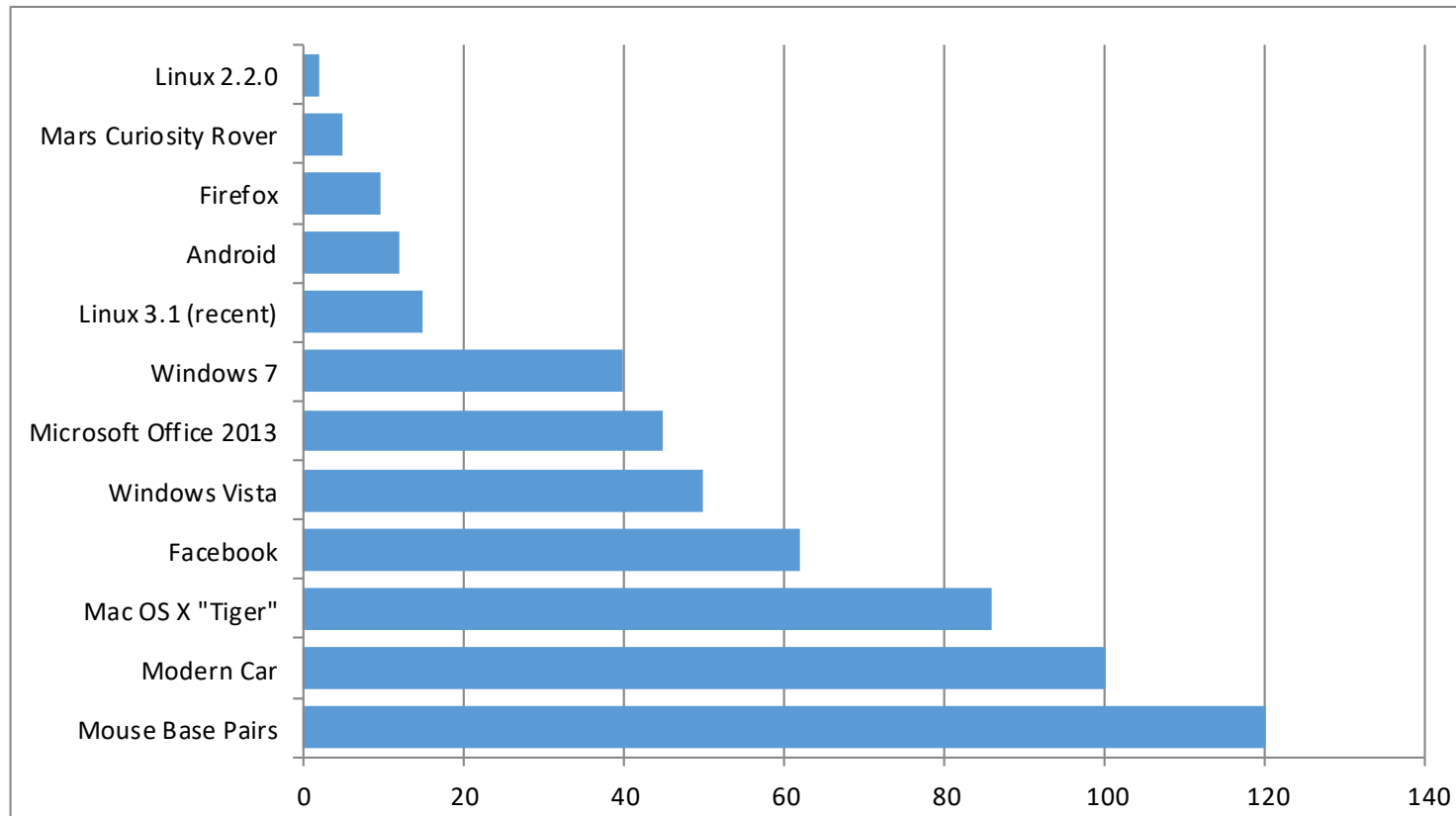

**Millions of Lines of Code**

(source <https://informationisbeautiful.net/visualizations/million-lines-of-code/>)

## Example: Some Mars Rover (“Pathfinder”) Requirements

---

- Pathfinder hardware limitations/complexity:
  - 20Mhz processor, 128MB of DRAM, VxWorks OS
  - cameras, scientific instruments, batteries, solar panels, and locomotion equipment
  - Many independent processes work together
- Can’t hit reset button very easily!
  - Must reboot itself if necessary
  - Must always be able to receive commands from Earth
- Individual Programs must not interfere
  - Suppose the MUT (Martian Universal Translator Module) buggy
  - Better not crash antenna positioning software!
- Further, all software may crash occasionally
  - Automatic restart with diagnostics sent to Earth
  - Periodic checkpoint of results saved?
- Certain functions time critical:
  - Need to stop before hitting something
  - Must track orbit of Earth for communication
- **A lot of similarity with the Internet of Things?**
  - **Complexity, QoS, Inaccessibility, Power limitations ... ?**

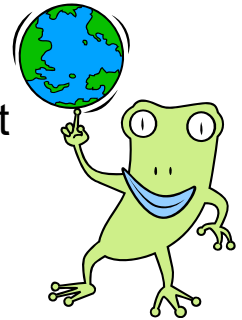



## Questions

---

- Does the programmer need to write a single program that performs many independent activities?
- Does every program have to be altered for every piece of hardware?
- Does a faulty program crash everything?
- Does every program have access to all hardware?

**Hopefully, no!**

**Operating Systems help the programmer write robust programs!**

# OS *Abstracts* the Underlying Hardware

---

- Processor → Thread
- Memory → Address Space
- Disks, SSDs, ... → Files
- Networks → Sockets
- Machines → Processes

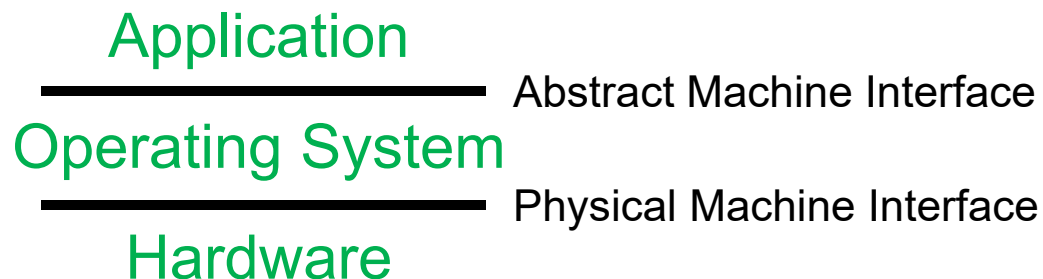

- OS as an *Illusionist*:
  - Remove software/hardware quirks (*fight complexity*)
  - Optimize for convenience, utilization, reliability, ... (*help the programmer*)
- For any OS area (e.g. file systems, virtual memory, networking, scheduling):
  - What hardware interface to handle? (physical reality)
  - What's software interface to provide? (nicer abstraction)

# OS *Protects* Processes and the Kernel

---

- Run multiple applications and:
  - Keep them from interfering with or crashing the operating system
  - Keep them from interfering with or crashing each other

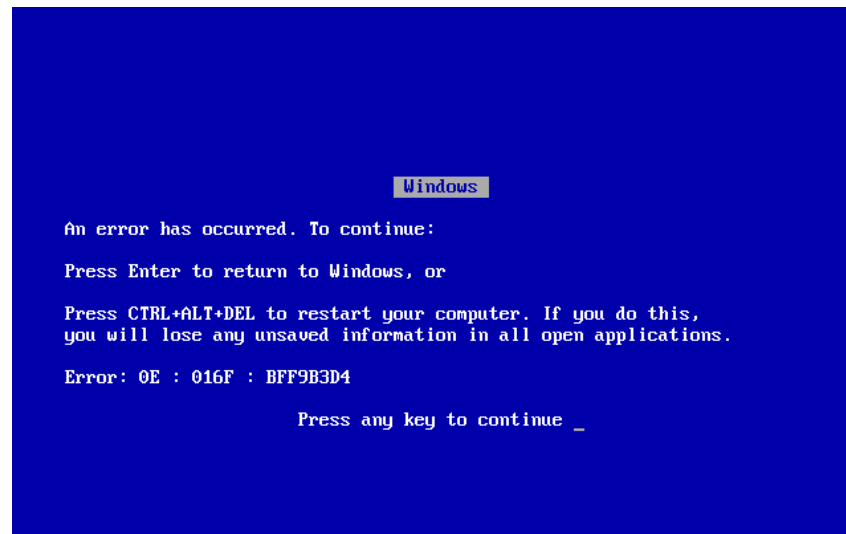

# Basic Tool: Dual-Mode Operation

- Hardware provides at least two modes:
  1. Kernel Mode (or “supervisor” mode)
  2. User Mode
- Certain operations are **prohibited** when running in user mode
  - Changing the page table pointer, disabling interrupts, interacting directly w/ hardware, writing to kernel memory
- Carefully controlled transitions between user mode and kernel mode
  - System calls, interrupts, exceptions

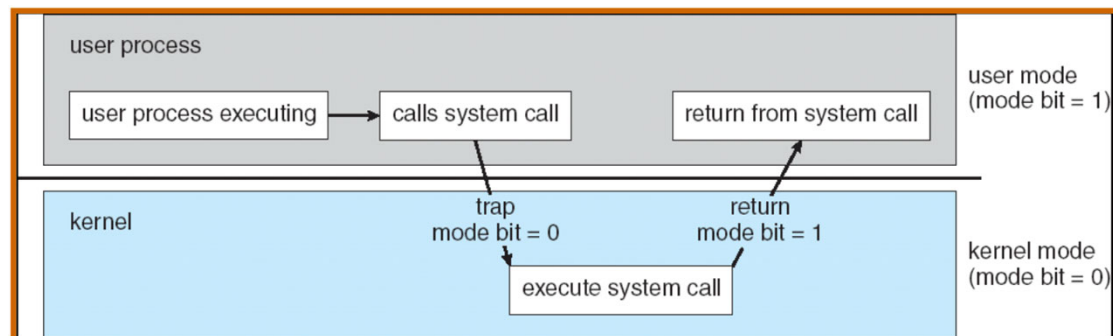

# UNIX System Structure

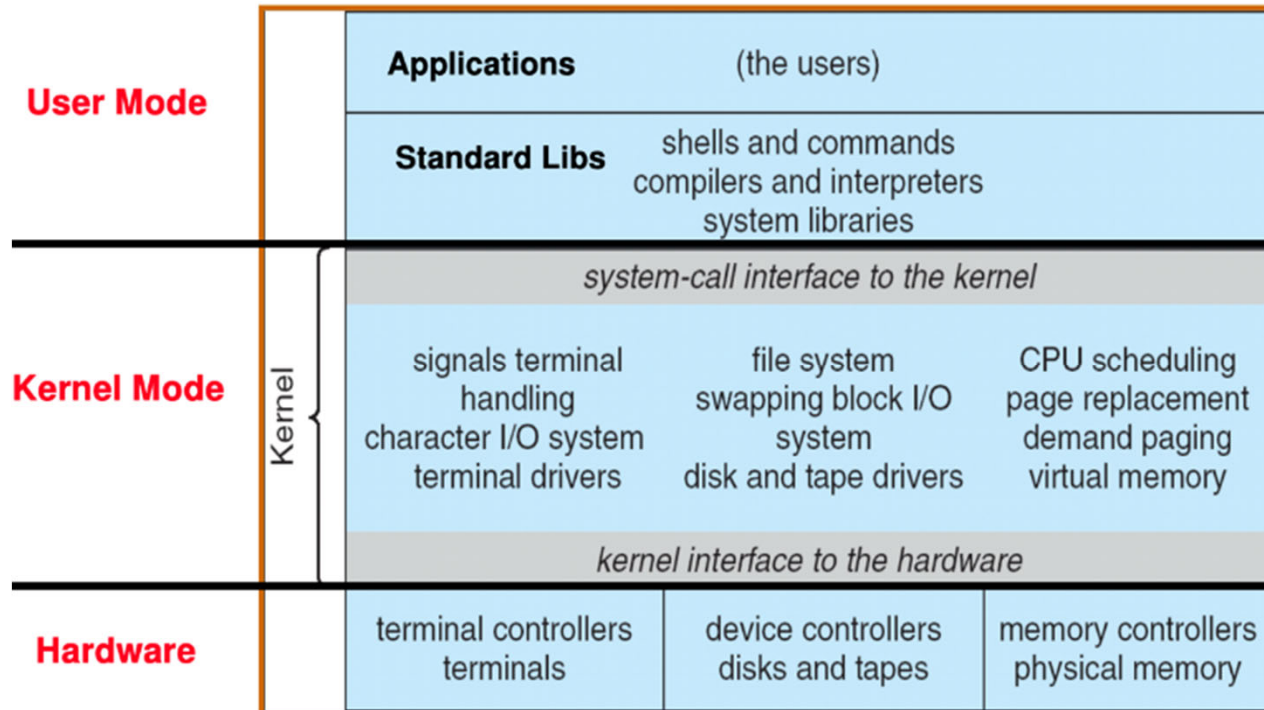

# Virtualization: Execution Environments for Systems

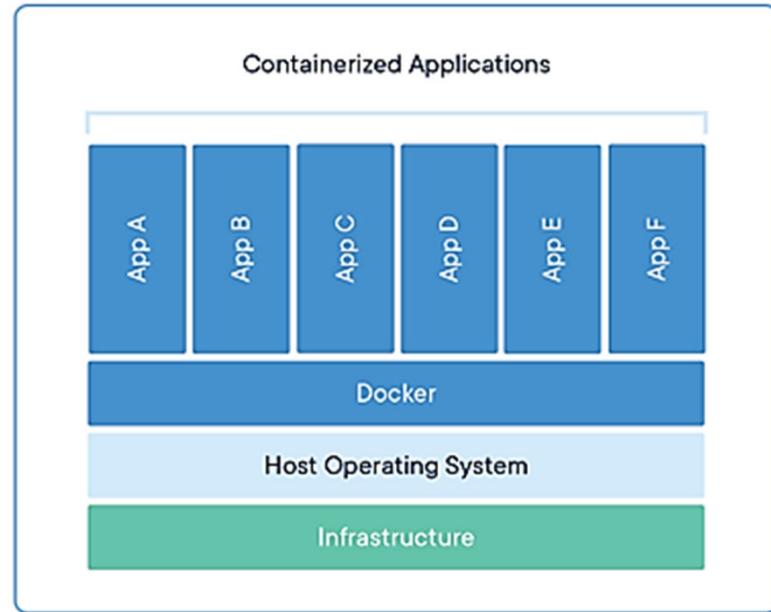
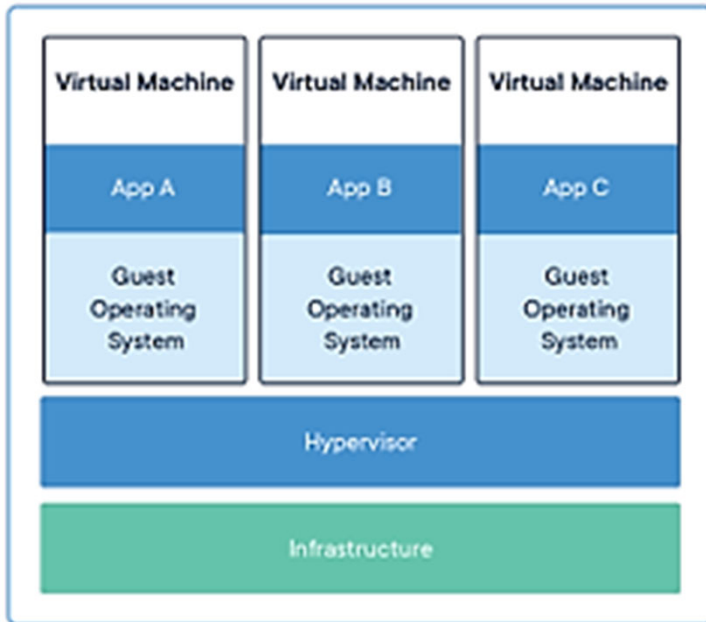

**Additional layers of protection and isolation can help further manage complexity**

# What is an Operating System,... Really?

---

- Most Likely:
  - Memory Management
  - I/O Management
  - CPU Scheduling
  - Communications? (Does Email belong in OS?)
  - Multitasking/multiprogramming?
- What about?
  - File System?
  - Multimedia Support?
  - User Interface?
  - Internet Browser? 😊
- Is this only interesting to Academics??

## Operating System Definition (Cont.)

---

- No universally accepted definition
- “Everything a vendor ships when you order an operating system” is good approximation
  - But varies wildly
- “The one program running at all times on the computer” is the **kernel**
  - Everything else is either a system program (ships with the operating system) or an application program



## “In conclusion...Operating Systems:”

---

- Provide convenient abstractions to handle diverse hardware
  - Convenience, protection, reliability obtained in creating the illusion
- Coordinate resources and protect users from each other
  - Using a few critical hardware mechanisms
- Simplify application development by providing standard services
- Provide fault containment, fault tolerance, and fault recovery
  
- CS162 combines things from many other areas of computer science:
  - Languages, data structures, hardware, and algorithms