

GLSL Introduction

Fu-Chung Huang

Thanks for materials from many other people

Shader Languages

- Currently 3 major shader languages
 - Cg (Nvidia)
 - HLSL (Microsoft)
 - Derived from Cg
 - GLSL (OpenGL)
- Main influences are
 - C language
 - pre-existing Shader languages developed in university and industry

Source: http://http.developer.nvidia.com/CgTutorial/cg_tutorial_chapter01.html (Modified with information on HLSL and GLSL)

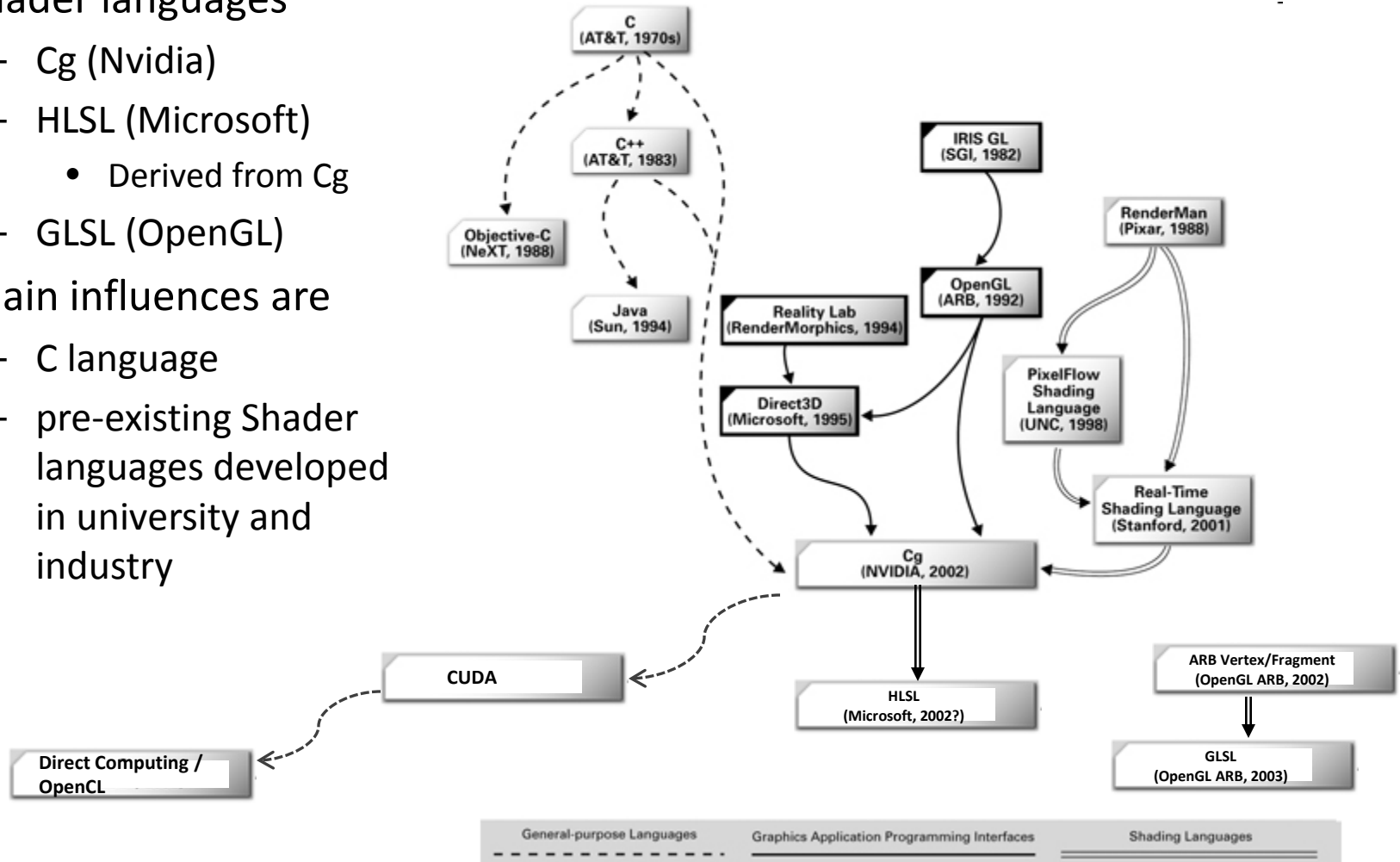

Classical OpenGL Rendering Pipeline

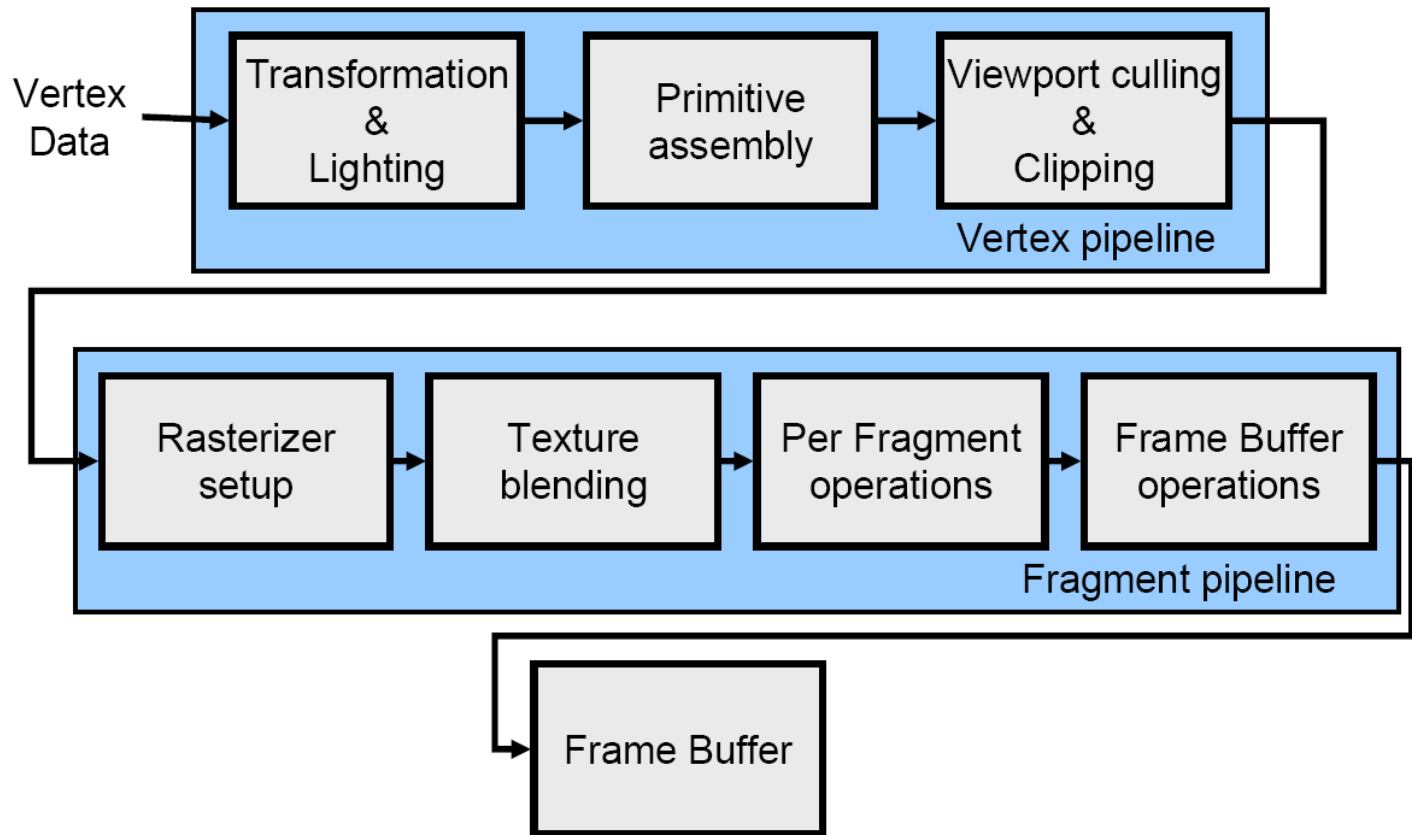

Fixed Functionality

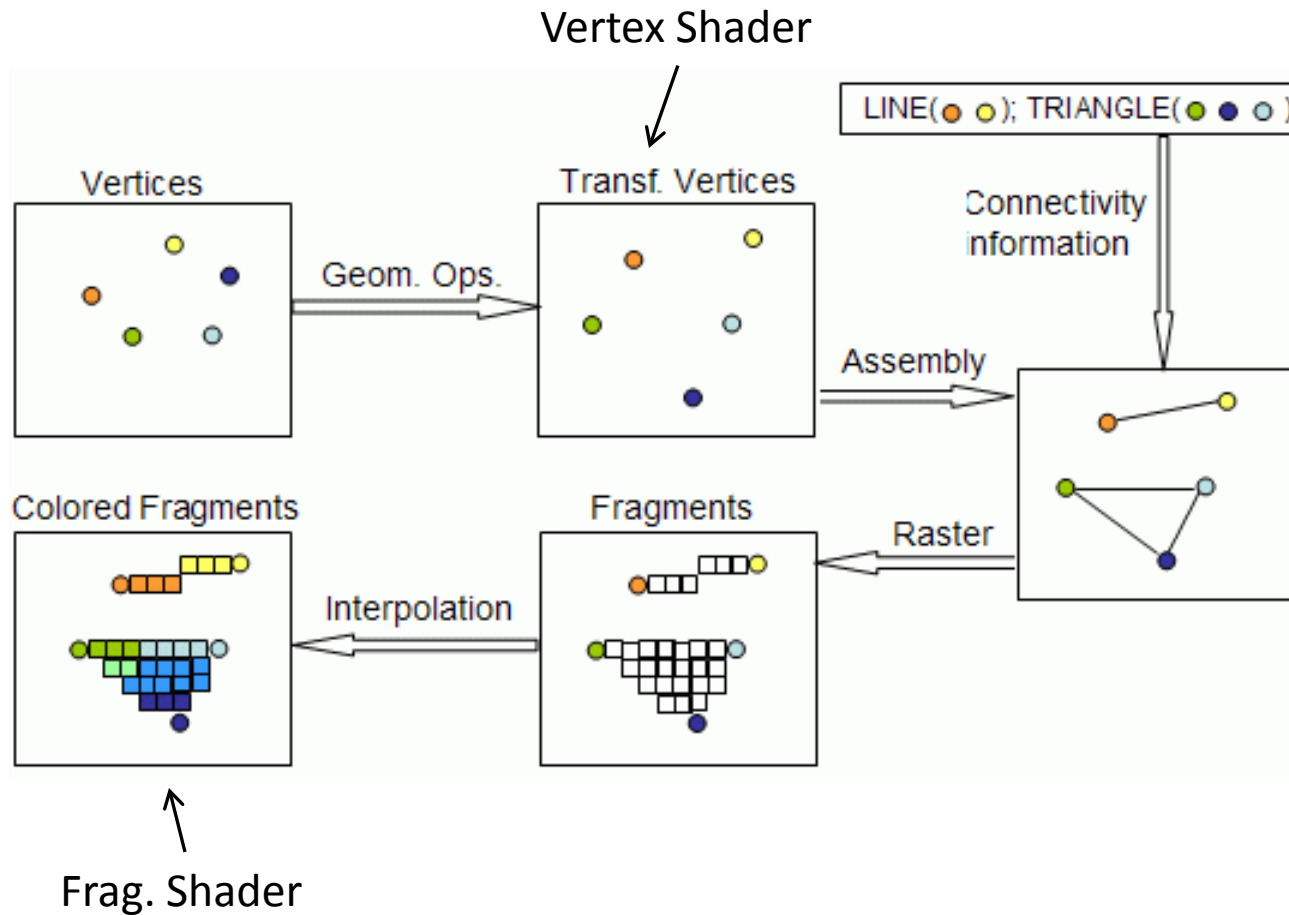

Shader Initialization

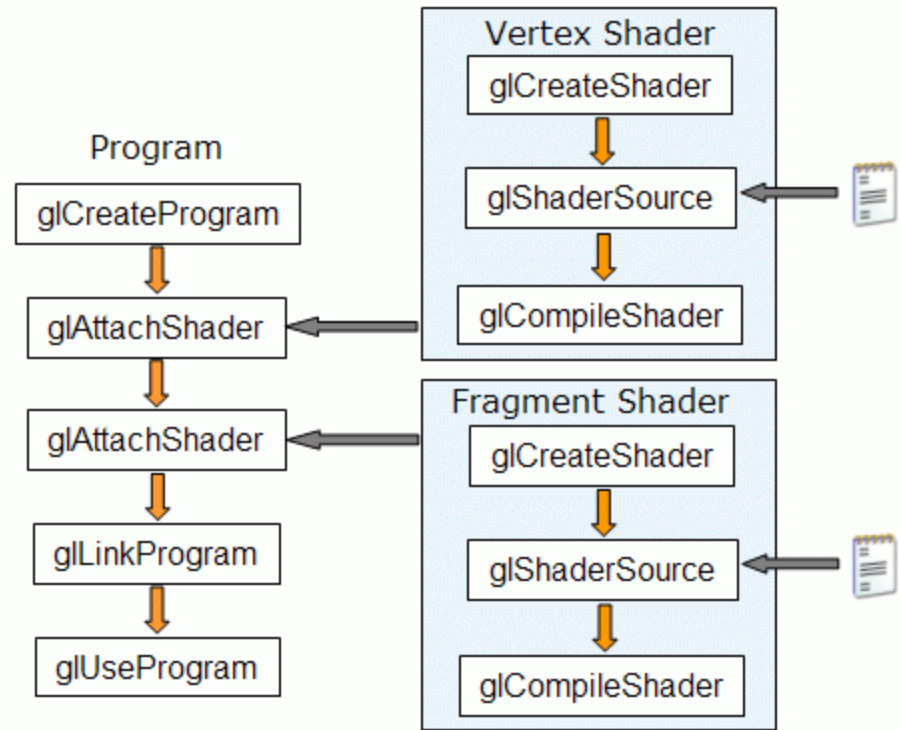

Qualifiers in pipeline

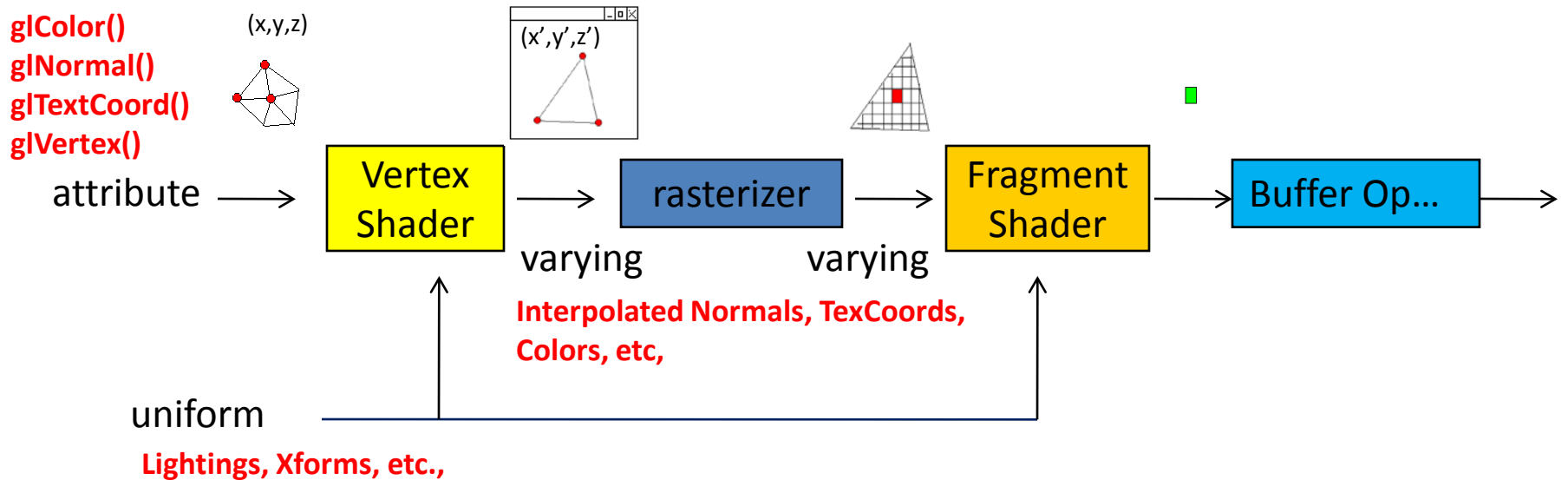

Really Complicated Pipeline

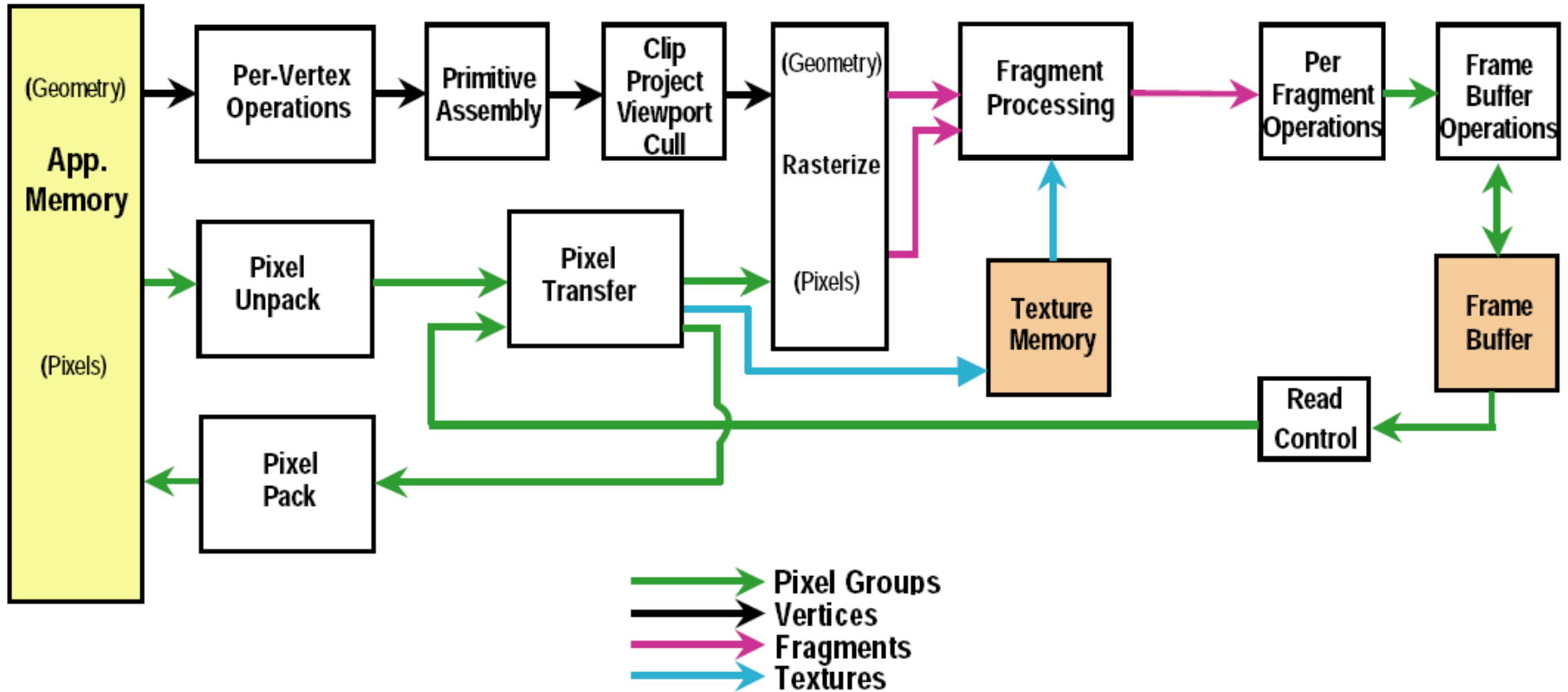

Data Flows

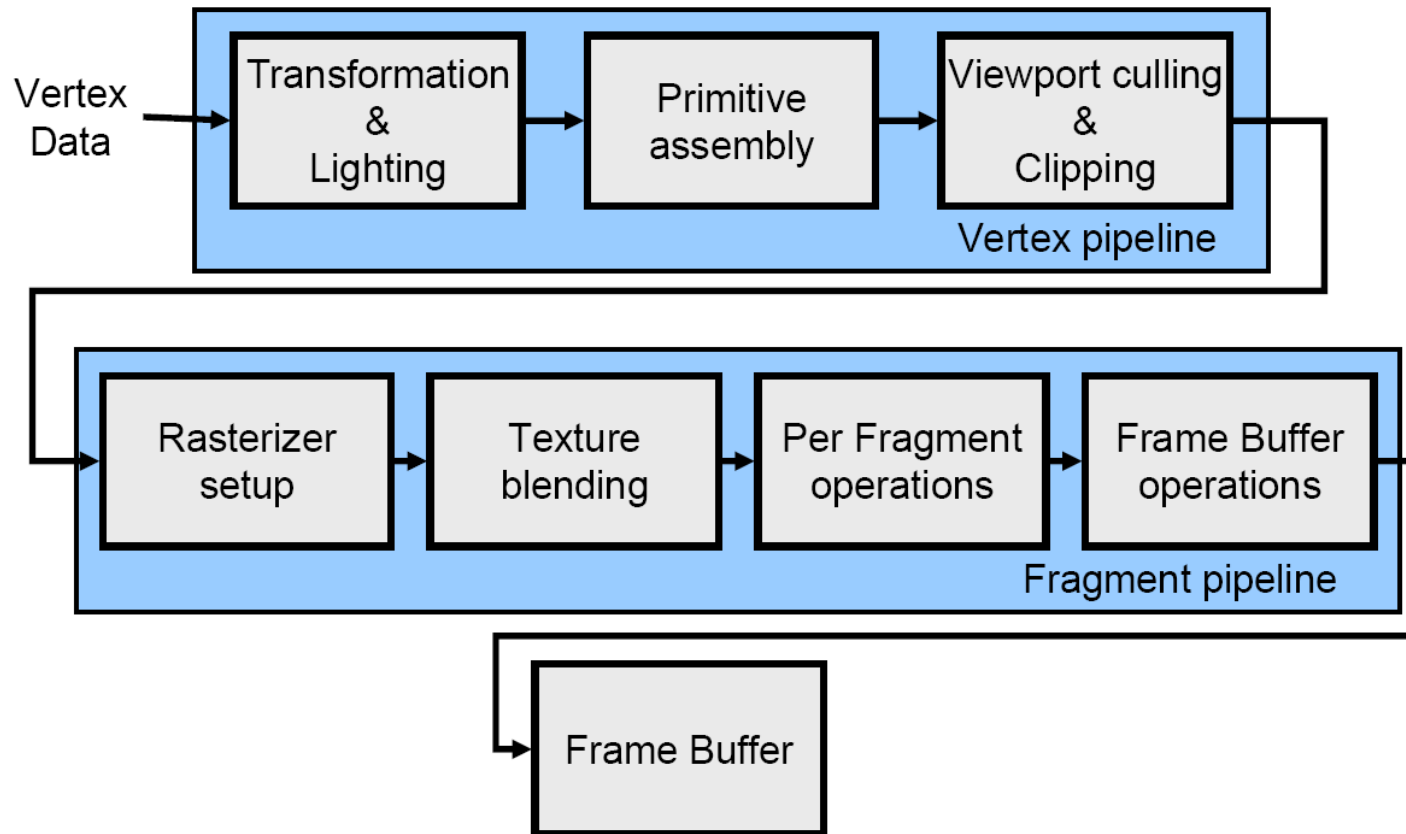

Vertex Shader

- Vertex Xform
- Normal Xform
- Text Coord
- Per-vertex lighting

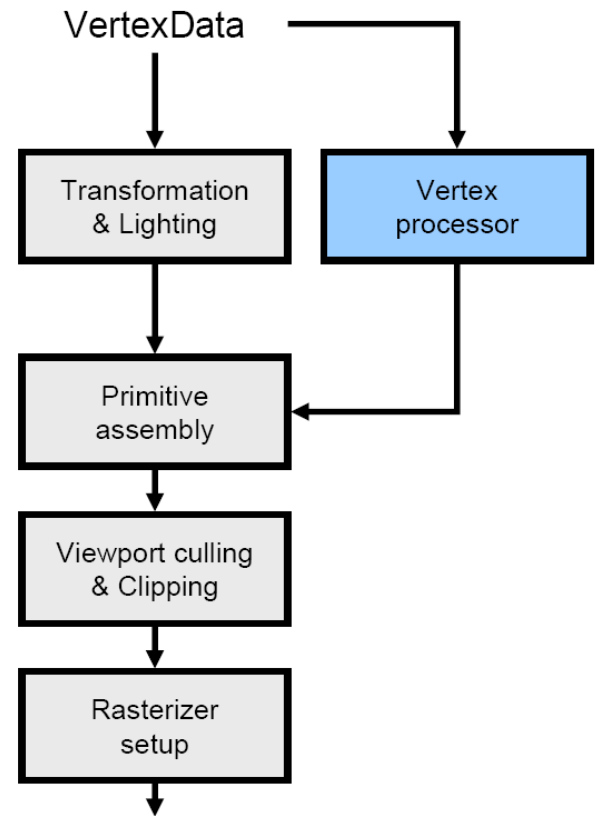

Vertex Shader

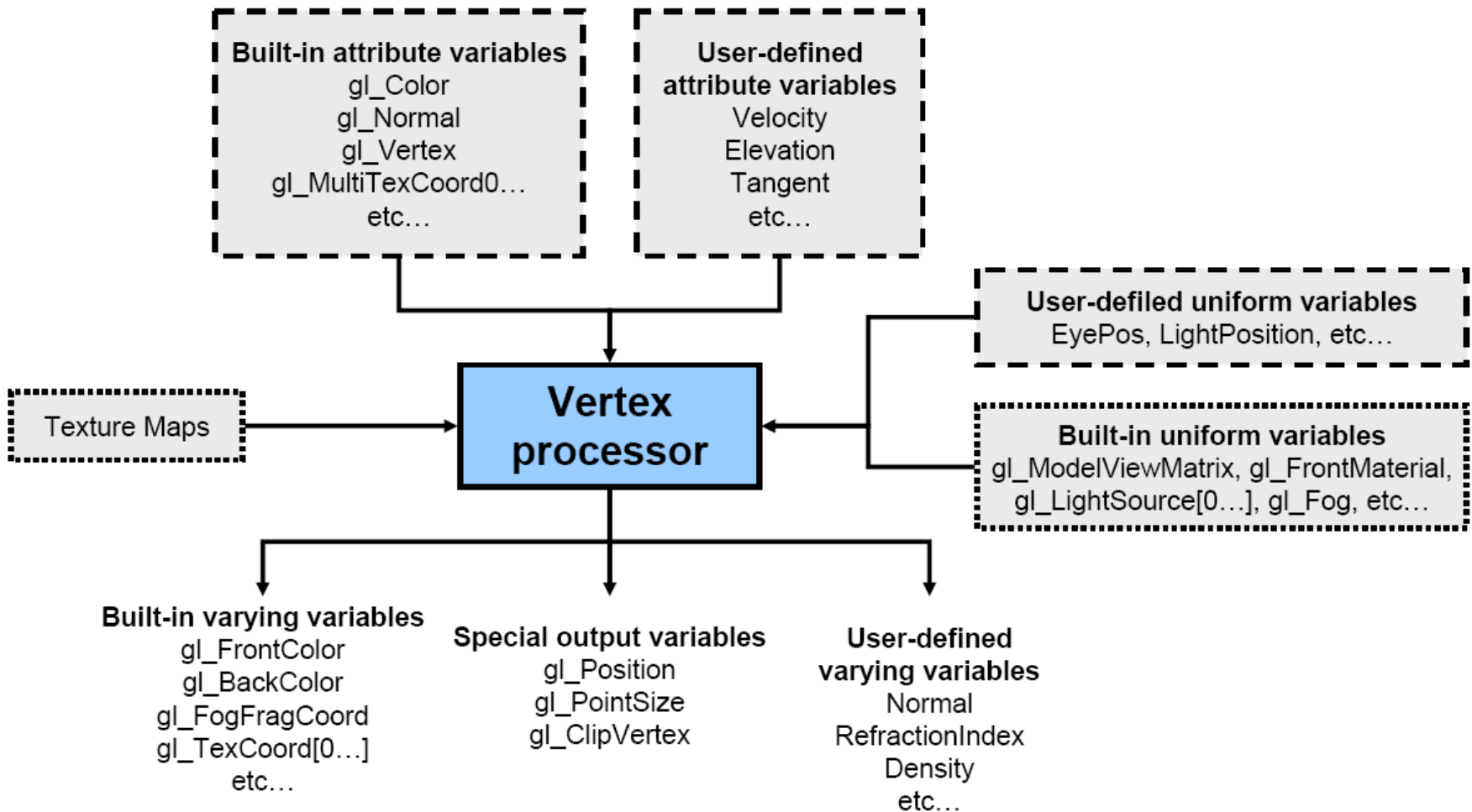

Fragment (pixel) Shader

- Interpolated
- Texture access
- Applications
 - Texture
 - Fog
 - Color sum

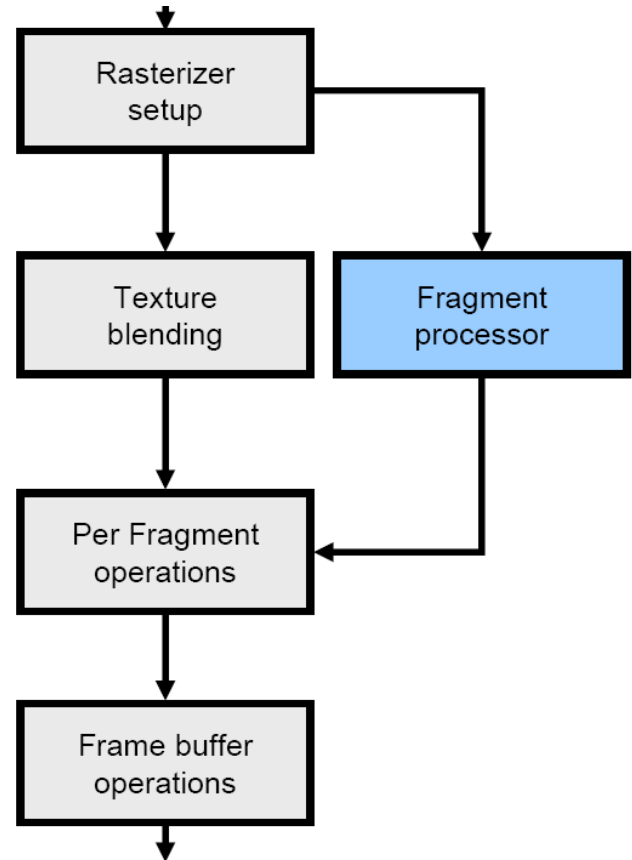

Fragment Shader

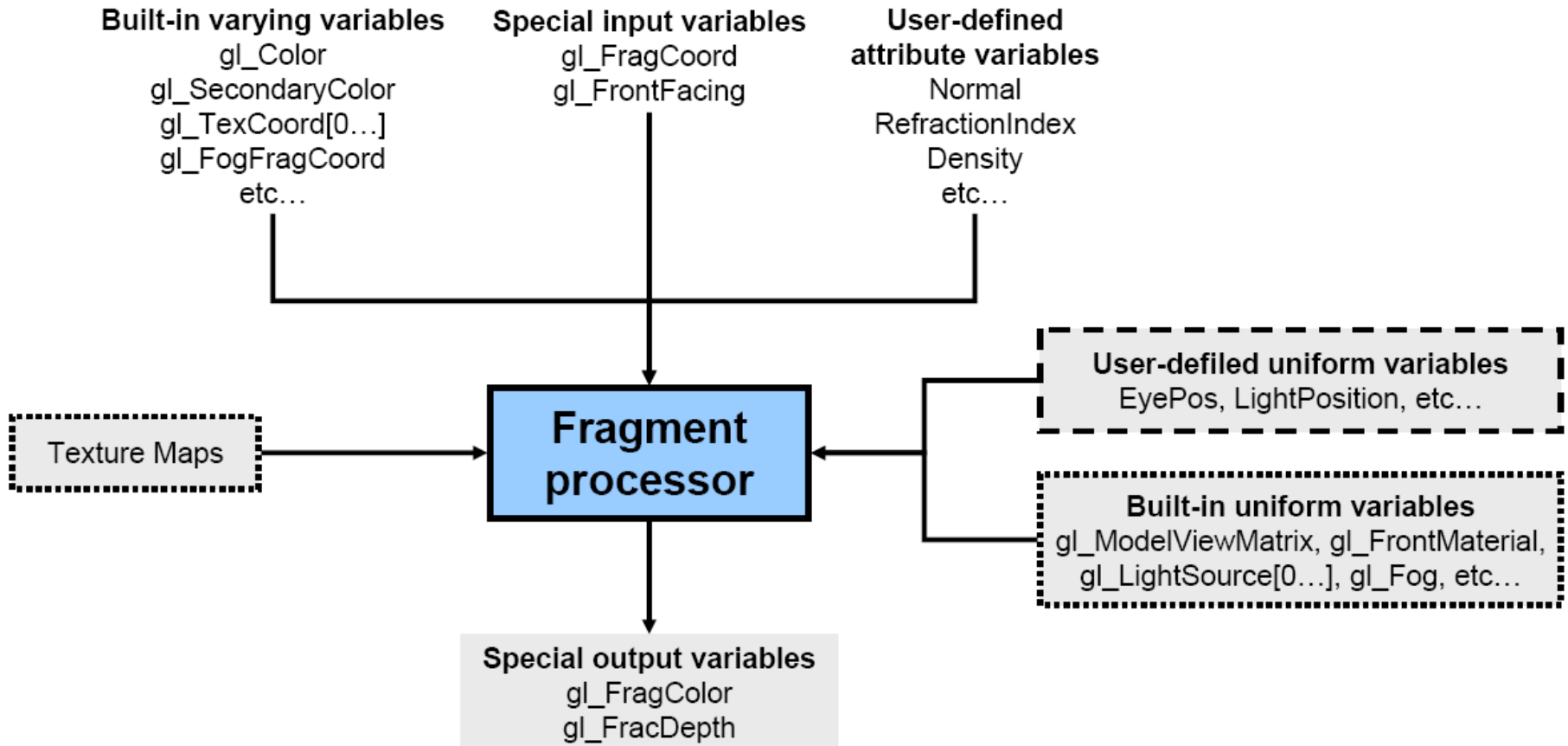

GLSL Language Definition

- Data Type Description
 - **int** Integer
 - **float** Floating-point
 - **bool** Boolean (*true* or *false*).
 - **vec2** Vector with two floats.
 - **vec3** Vector with three floats.
 - **vec4** Vector with four floats.
 - **mat2** 2x2 floating-point matrix.
 - **mat3** 3x3 floating-point matrix.
 - **mat4** 4x4 floating-point matrix.

Vector

- Vector is like a class
- You can use following to access
 - .r .g .b .a
 - .x .y .z .w
 - .s .t .p .q
- Example:

```
vec4 color;  
color.rgb = vec3(1.0 , 1.0 , 0.0 );           color.a = 0.5  
color = vec4(1.0 , 1.0 , 0.0 , 0.5);  
color.xy = vec2(1.0 , 1.0);  
color.zw =vec2(0.0 , 0.5);
```

GLSL Variable Qualifiers

- Qualifiers give a special meaning to the variable. In GLSL the following qualifiers are available:
 - **const** - the declaration is of a compile time constant
 - **uniform** – (used both in vertex/fragment shaders, read-only in both) global variables that may change per primitive (may not be set inside glBegin,/glEnd)
 - **varying** - used for interpolated data between a vertex shader and a fragment shader. Available for writing in the vertex shader, and read-only in a fragment shader.
 - **attribute** – (only used in vertex shaders, and read-only in shader) global variables that may change per vertex, that are passed from the OpenGL application to vertex shaders.

Vertex Shader Code Example

```
varying vec3 normal, lightDir, eyeDir;
```

```
void main()
```

```
{  
    normal = gl_NormalMatrix * gl_Normal;  
  
    vec3 vVertex = vec3(gl_ModelViewMatrix * gl_Vertex);  
  
    lightDir = vec3(gl_LightSource[0].position.xyz - vVertex);  
    eyeDir = -vVertex;  
  
    gl_Position = ftransform();  
}
```

Fragment Shader Code Example

```
varying vec3 normal, lightDir, eyeDir;
```

```
void main (void)
```

```
{
```

```
    vec4 final_color =  
    (gl_FrontLightModelProduct.sceneColor * gl_FrontMaterial.ambient) +  
    (gl_LightSource[0].ambient * gl_FrontMaterial.ambient);
```

```
    vec3 N = normalize(normal);
```

```
    vec3 L = normalize(lightDir);
```

```
    float lambertTerm = dot(N,L);
```

```
    if(lambertTerm > 0.0)
```

```
{
```

```
        final_color += gl_LightSource[0].diffuse * gl_FrontMaterial.diffuse * lambertTerm;
```

```
        vec3 E = normalize(eyeDir);
```

```
        vec3 R = reflect(-L, N);
```

```
        float specular = pow( max(dot(R, E), 0.0), gl_FrontMaterial.shininess );
```

```
        final_color += gl_LightSource[0].specular * gl_FrontMaterial.specular * specular;
```

```
}
```

```
    gl_FragColor = final_color;
```

```
}
```

Vertex vs. Fragment Shader

Smooth Shading



per vertex lighting

Phong Shading



per fragment lighting

Result

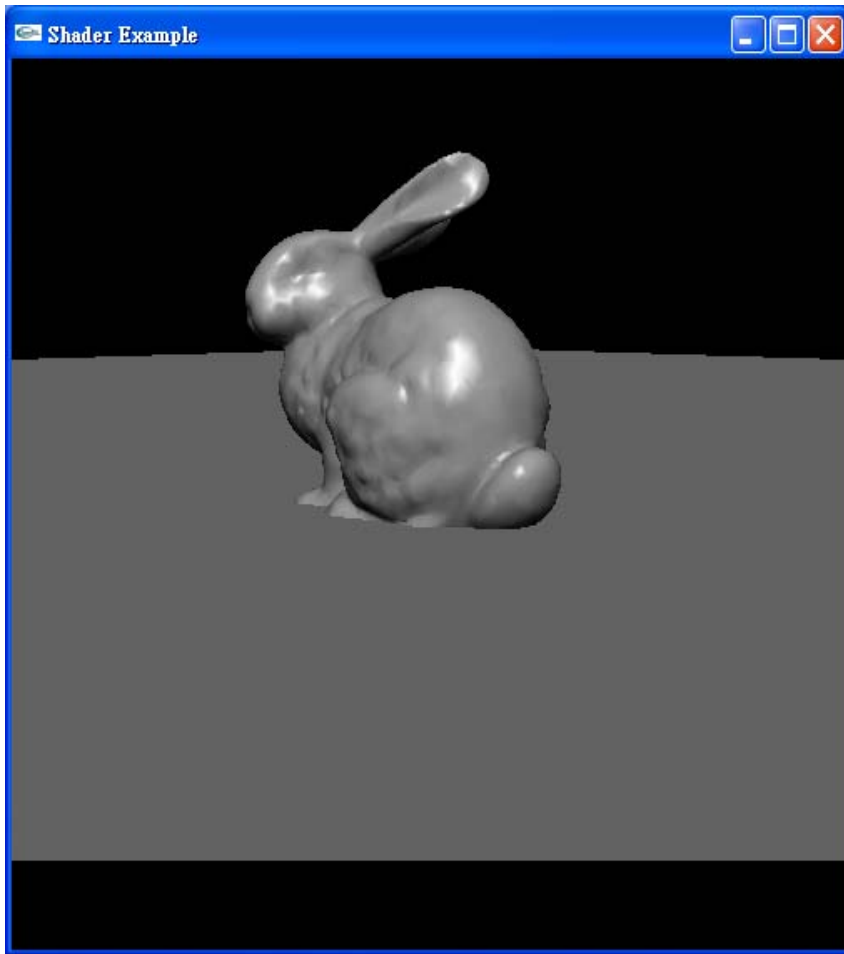

OpenGL Gouraud Shading

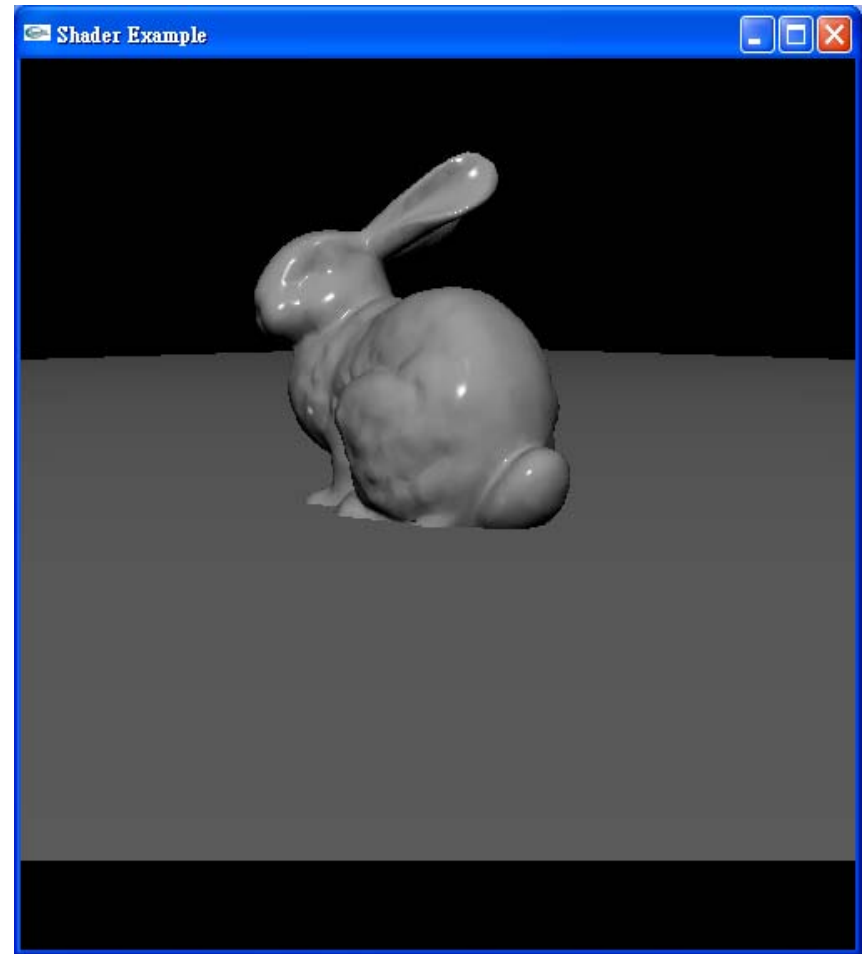

GLSL Phong Shading

GLSL Statements

- Control Flow Statements: pretty much the same as in C.
- **HIGHLY HARDWARE DEPENDENT!!**

```
if (bool expression)
```

```
...
```

```
else
```

```
...
```

```
for (initialization; bool expression; loop expression)
```

```
...
```

```
while (bool expression)
```

```
...
```

```
do
```

```
...
```

```
while (bool expression)
```

Note: only “if” are available on most current hardware

Fragment Shader Applications

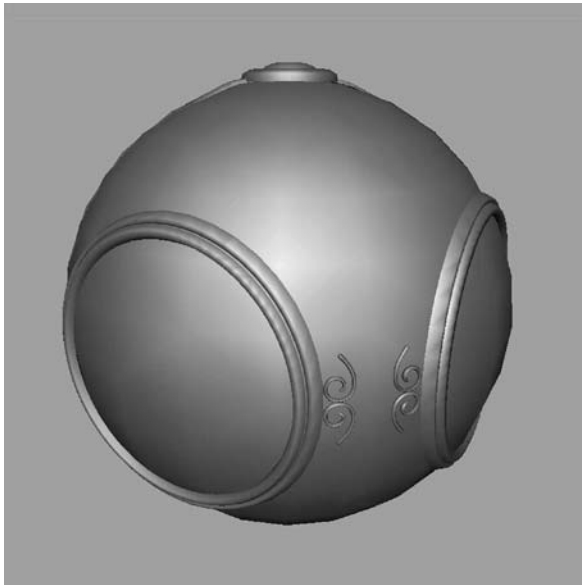

smooth shading



environment
mapping

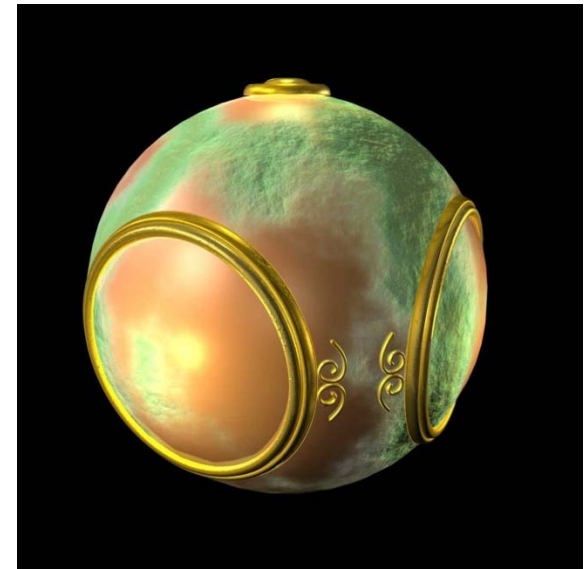

bump mapping

Bump Mapping

- Perturb normal for each fragment
- Store perturbation as textures

