

61A Lecture 37

Announcements

Ambiguity

Syntactic Ambiguity in English

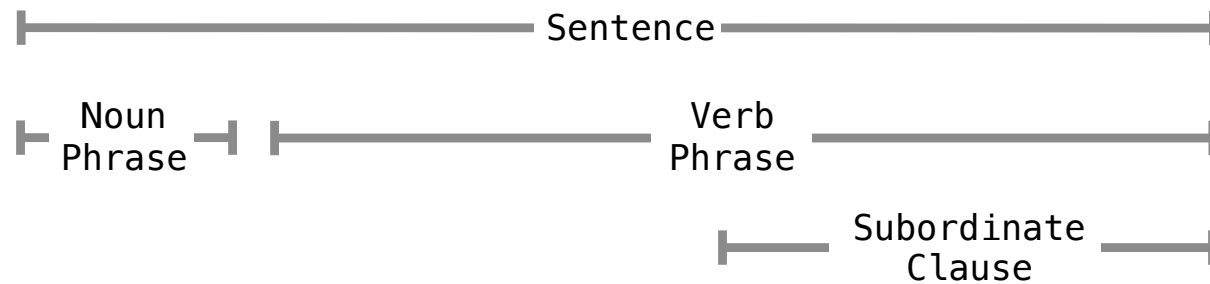

Programs must be written for people to read¹

¹Preface of **Structure and Interpretation of Computer Programs**
by Harold Abelson and Gerald Sussman with Julie Sussman

Syntactic Ambiguity in English

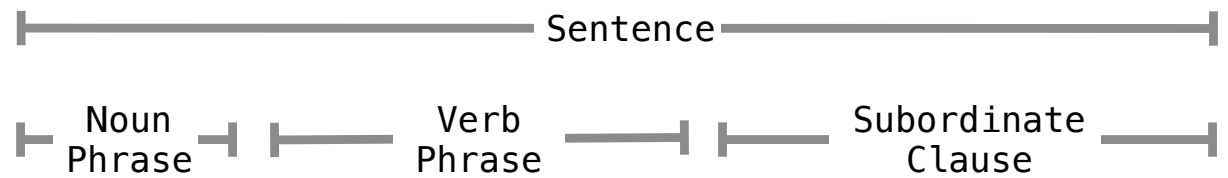

Programs must be written for people to read¹

¹Preface of **Structure and Interpretation of Computer Programs**
by Harold Abelson and Gerald Sussman with Julie Sussman

Syntactic Ambiguity in English

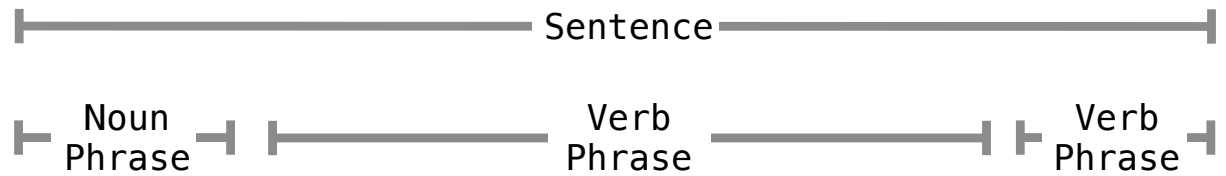

Programs must be written for people to read¹

¹Preface of **Structure and Interpretation of Computer Programs**
by Harold Abelson and Gerald Sussman with Julie Sussman

Syntactic Ambiguity in English

pro•gram (noun)

a series of coded software instructions

pro•gram (verb)

provide a computer with coded instructions

Programs must be written for people to read

must (verb)

be obliged to

must (noun)

dampness or mold

Syntax Trees

Representing Syntactic Structure



Photo by Vince O'Sullivan licensed under <http://creativecommons.org/licenses/by-nc-nd/2.0/>

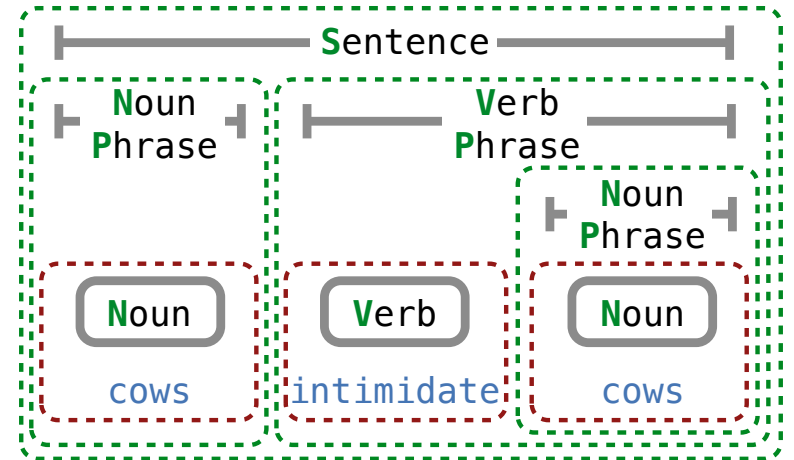

A **Tree** represents a phrase:

- **tag** -- What kind of phrase (e.g., **S**, **NP**, **VP**)
- **branches** -- Sequence of **Tree** or **Leaf** components

A **Leaf** represents a single word:

- **tag** -- What kind of word (e.g., **N**, **V**)
- **word** -- The word

```
cows = Leaf('N', 'cows')
```

```
intimidate = Leaf('V', 'intimidate')
```

```
S, NP, VP = 'S', 'NP', 'VP'
```

```
Tree(S, [Tree(NP, [cows]),  
         Tree(VP, [intimidate,  
                  Tree(NP, [cows])])])])
```

(Demo)

Grammars

Context-Free Grammar Rules

A grammar rule describes how a tag can be expanded as a sequence of tags or words

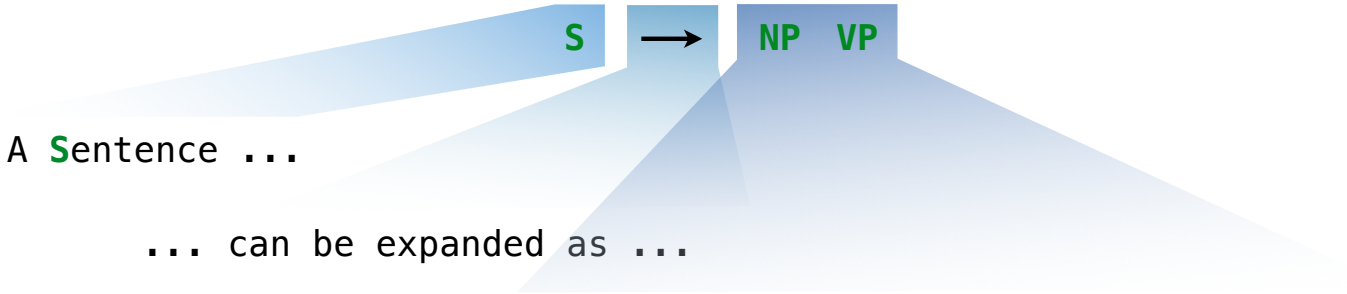

... a **Noun** **Phrase** then a **Verb** **Phrase**.

Grammar	
S	→ NP VP
NP	→ N
N	→ cows
VP	→ V NP
V	→ intimidate

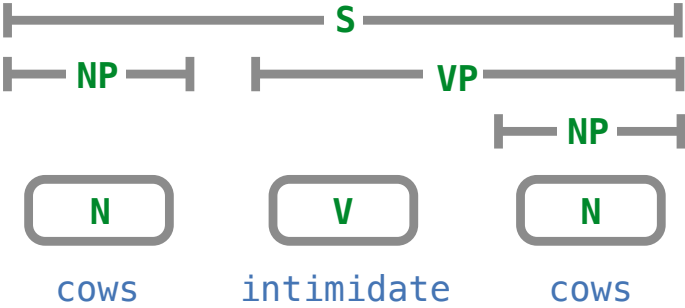

(Demo)

Parsing

Exhaustive Parsing

Expand all tags recursively, but constrain words to match input

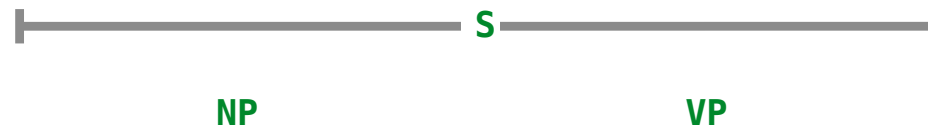

Exhaustive Parsing

Expand all tags recursively, but constrain words to match input

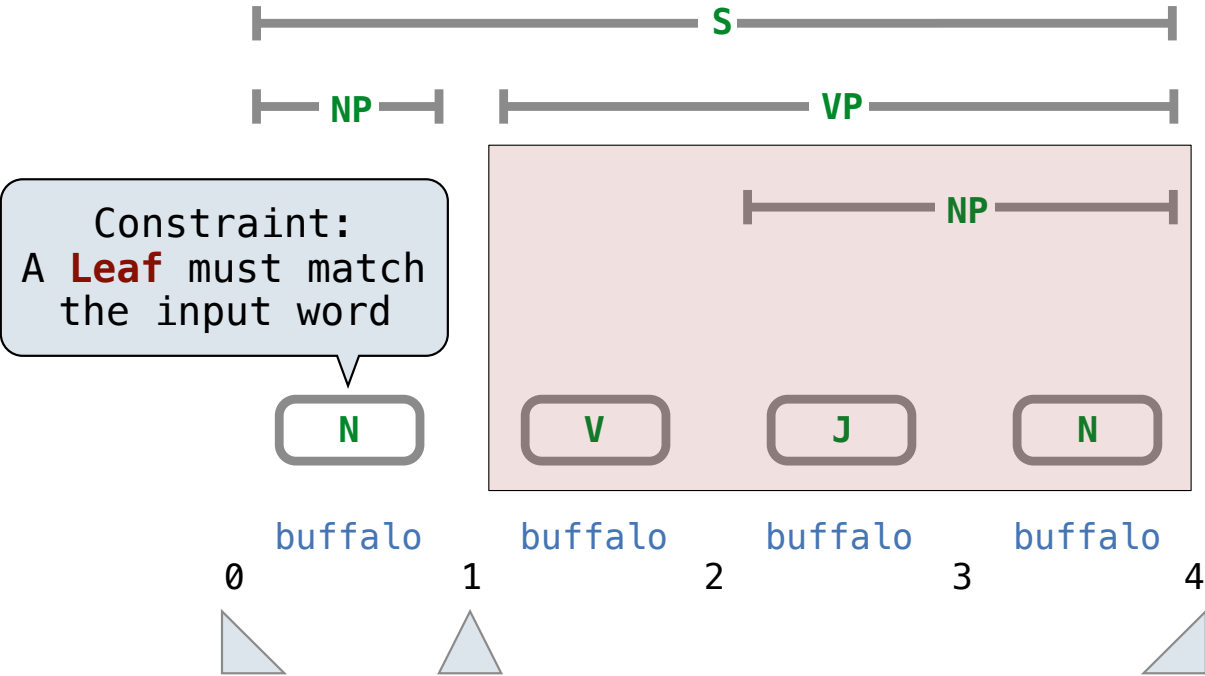

Exhaustive Parsing

Expand all tags recursively, but constrain words to match input

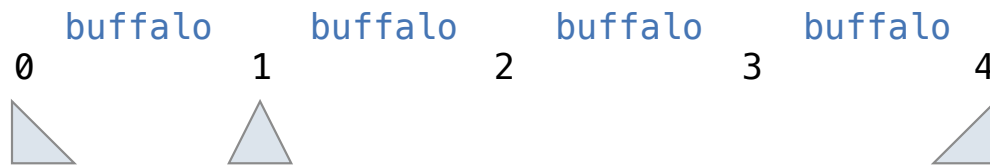
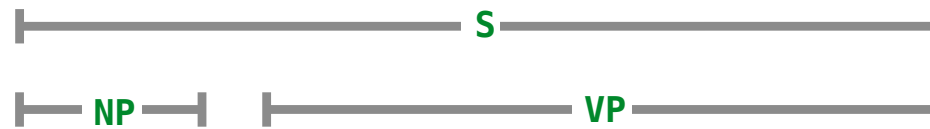

Exhaustive Parsing

Expand all tags recursively, but constrain words to match input

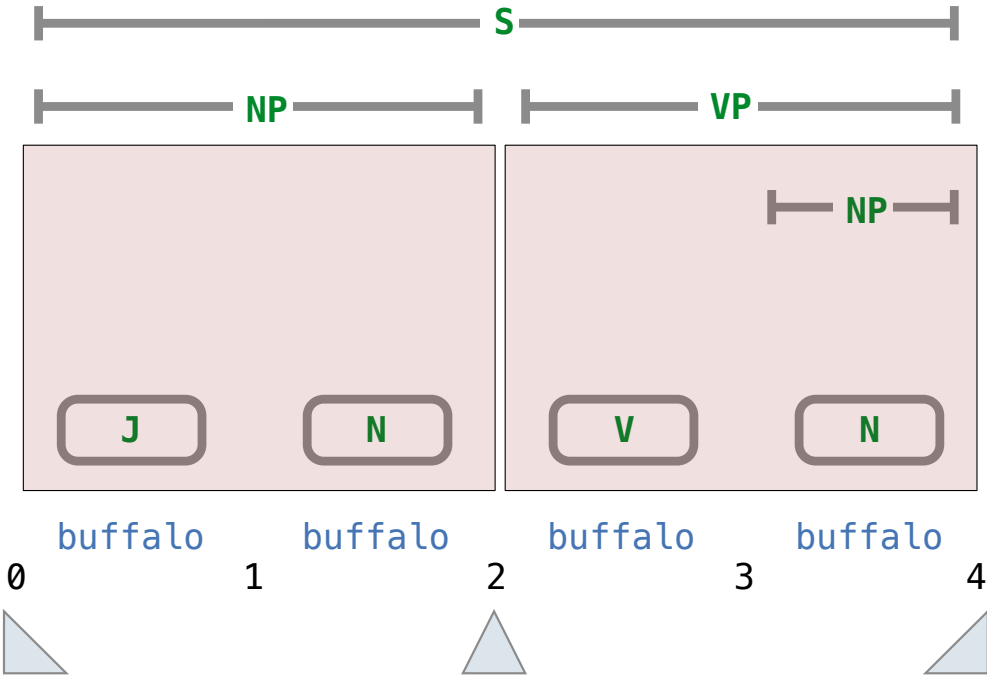

(Demo)

Learning

(Demo)

Scoring a Tree Using Relative Frequencies

Not all syntactic structures are equally common

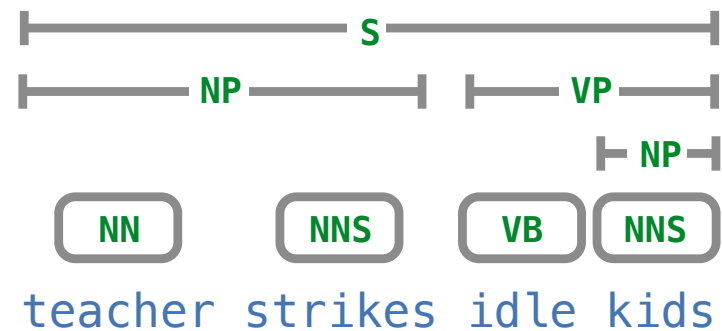

Rule frequency per 100,000 tags

S	→	NP	VP	25372	NN	→	teacher	5
NP	→	NN	NNS	1335	NNS	→	strikes	25
VP	→	VB	NP	6679	VB	→	idle	26
NP	→	NNS		4282	NNS	→	kids	32

Scoring a Tree Using Relative Frequencies

Not all syntactic structures are equally common

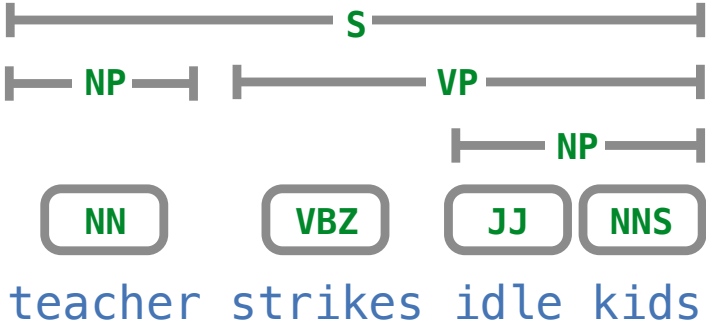

Rule frequency per 100,000 tags

S	→	NP	VP	25372	NN	→	teacher	5	
NP	→	NN		1335	4358	VBZ	→	strikes	25 19
VP	→	VBZ	NP	6679	3160	JJ	→	idle	26 18
NP	→	JJ	NNS	4282	2526	NNS	→	kids	32

(Demo)

Translation

Syntactic Reordering

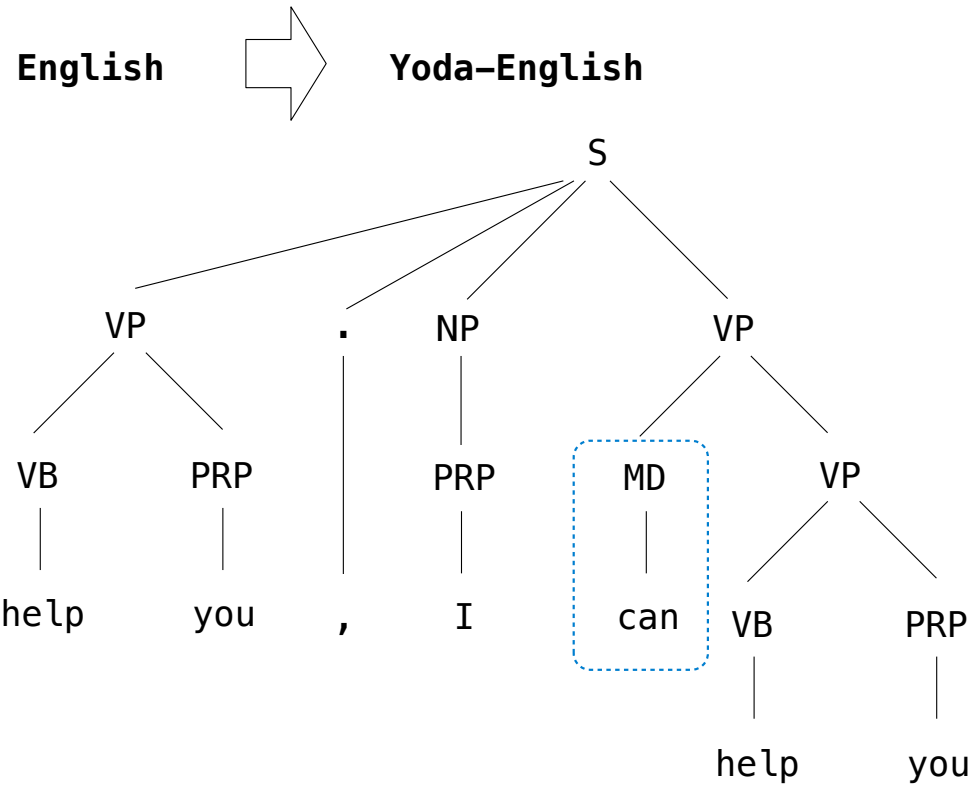

(Demo)

Help you, I can!
Yes! Mm!

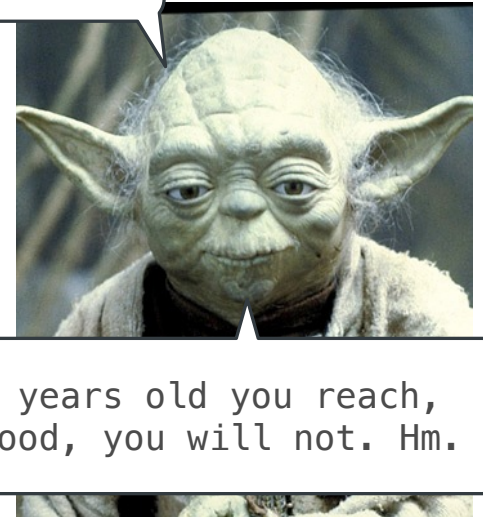

When 900 years old you reach,
look as good, you will not. Hm.