

EE16A Circuits Cookbook

EE16A Staff, Past and Present

Last Modified: October 28, 2018

Design Topologies

Here are very useful circuit topologies that you might want to consider using when you hear key phrases or goals in the problem. You never have to rederive the formulas for these circuits unless we explicitly ask. Just put these down on your cheatsheets and use them!!!

Design Strategy

Things to consider:

- What components are you allowed to use?
- What are the goals of the design? (look for key phrases)
- What topology should you use? Is it enough to meet your goal or do you need a combination of multiple topologies?
- Are you driving a load and does your input have a source resistance?
- Gain/division will often depend on the ratio of two resistors or capacitors. Pick a value for one and solve for the other. (Typical and reasonable values would be $R = 1k\Omega$ and $C = 1\mu F$).

The designs we've listed here is not a catch-all for design. That said, here are some very common designs:

1. **Key Phrase:** isolate load, buffer

Use a buffer

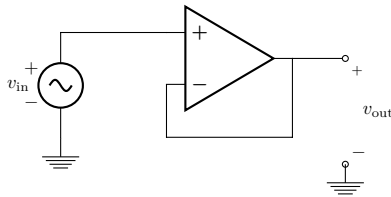

$$v_{\text{out}} = v_{\text{in}}$$

2. **Key Phrase:** positive gain

Use a noninverting amp. Note that this still has infinite input resistance and zero output resistance just like a buffer.

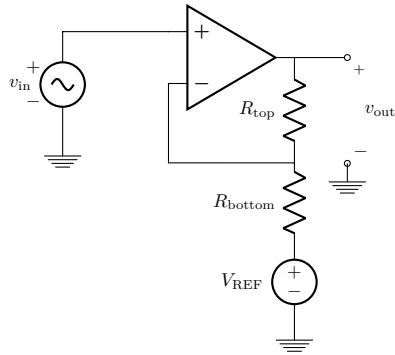

$$v_{\text{out}} = v_{\text{in}} \left(1 + \frac{R_{\text{top}}}{R_{\text{bottom}}} \right) - V_{\text{REF}} \left(\frac{R_{\text{top}}}{R_{\text{bottom}}} \right)$$

3. **Key Phrase:** negative gain

Use an inverting amp. Note that this does not have infinite input resistance so it will load your input signal. It is recommended to use this after a buffer or if you know your input/source has no source resistance.

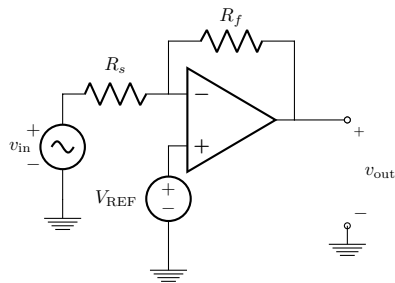

$$v_{\text{out}} = v_{\text{in}} \left(-\frac{R_f}{R_s} \right) + V_{\text{REF}} \left(\frac{R_f}{R_s} + 1 \right)$$

4. **Key Phrase:** convert current to voltage

Use a transresistance amplifier

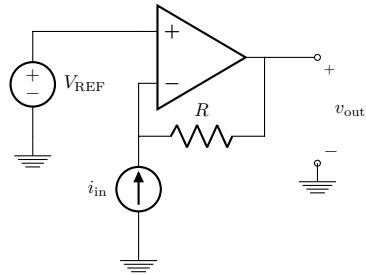

$$v_{out} = i_{in}(-R) + V_{REF}$$

5. **Key Phrase:** divide voltage by some factor as a function of some R_i

Use a voltage divider

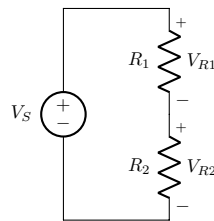

$$V_{Ri} = V_S \left(\frac{R_i}{R_1 + R_2} \right)$$

6. **Key Phrase:** divide current by a factor as a function of some resistance

Use a resistive current divider

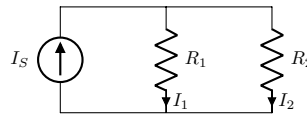

$$I_1 = I_S \left(\frac{R_2}{R_1 + R_2} \right)$$

7. **Key Phrase:** adding voltages, summing voltages

Use a summing circuit (note that this is a general form of the voltage divider)

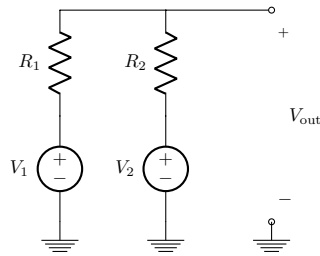

$$V_{out} = V_1 \left(\frac{R_2}{R_1 + R_2} \right) + V_2 \left(\frac{R_1}{R_1 + R_2} \right)$$

8. **Key Phrase:** compare two voltages v_1, v_2

The answer is in the phrase! Use a comparator

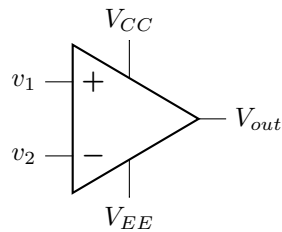

$$V_{out} = \begin{cases} V_{CC} & \text{if } v_1 > v_2 \\ V_{EE} & \text{if } v_1 < v_2 \end{cases}$$

9. **Key Phrase:** create a voltage which increases/decreases linearly with respect to time or a voltage ramp with a given slope

Use a current source with a capacitor

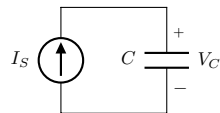

$$I_S = C \frac{dV_C}{dt} + V_C \frac{dC}{dt}$$

$$V_C(t) = V_C(t_0) + \frac{I_S}{C} (t - t_0)$$