

**EECS 42 Introduction to Electronics for
Computer Science
Andrew R. Neureuther**

Lecture # 13 Dependent Sources

- A) Dependent Source Concept**
- B) Four Basic Dependent Source Types**
- C) Use in Amplifier Models**
- D) Feedback and Ideal Op-Amp Model**
- E) Examples of Op-Amp Circuits**

<http://inst.EECS.Berkeley.EDU/~ee42/>

Game Plan 03/12/03

Monday 03/10/04

- Monday: Physical Limits of Logic (11.3, 11.4 pp 403-422)**

Wednesday 03/12/03:

- Dependent Sources (4.1 and 4.3)**

Next (9th) Week:

- Monday: Circuit analysis with dependent sources (4.1-4.3)**
- Wednesday: Comparators and op-amps (handout)**

Problem set #6: out Monday 3/3 and due at 2:30 3/10 in box in 240 Cory – logic functions, truth tables, synthesis, timing diagram

Problem set #7: out Wednesday 3/12 and due at 2:30 3/19 in box in 240 Cory – basic dependant sources and Op-Amp circuits

Dependent Voltage and Current Sources

A linear dependent source is a voltage or current source that depends linearly on some other circuit current or voltage.

Example: you watch a certain voltmeter V_1 and manually adjust a voltage source V_s to be 2.5 times this value.

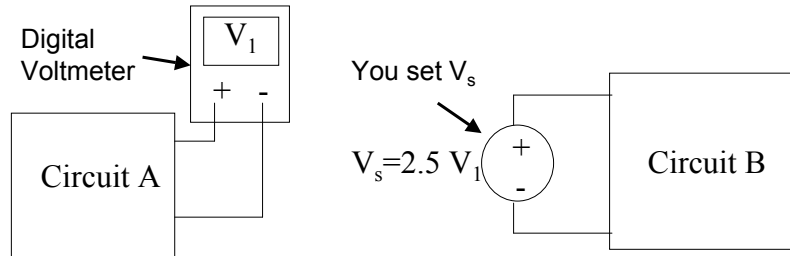

Copyright 2001, Regents of University of California

Dependent Voltage Source Example

The voltage V_s source depends linearly on V_1 (because you set it to 2.5 times V_1 , no matter what V_1 is).

If you and the voltmeter are placed inside a box, the box functions as a voltage-dependent voltage source.

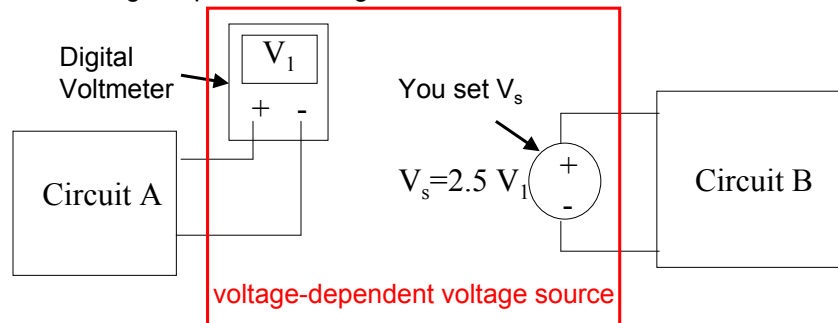

Note that the red box has two wires in (to read the input voltage) and two wires out (to deliver the output voltage).

Copyright 2001, Regents of University of California

Dependent Voltage and Current Sources

- A linear dependent source is a voltage or current source that depends linearly on some other circuit current or voltage.
- We can have voltage or current sources depending on voltages or currents elsewhere in the circuit.

Here the voltage V is proportional to the voltage across the element c-d .

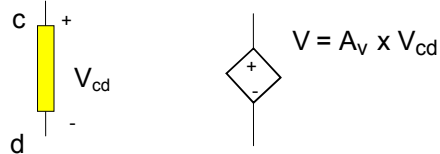

A diamond-shaped symbol is used for dependent sources, just as a reminder that it's a dependent source.

Circuit analysis is performed just as with independent sources.

The 4 Basic Linear Dependent Sources

Constant of proportionality

Parameter being sensed

Output

Voltage-controlled voltage source ... $V = A_v V_{cd}$

Current-controlled voltage source ... $V = R_m I_c$

Current-controlled current source ... $I = A_i I_c$

Voltage-controlled current source ... $I = G_m V_{cd}$

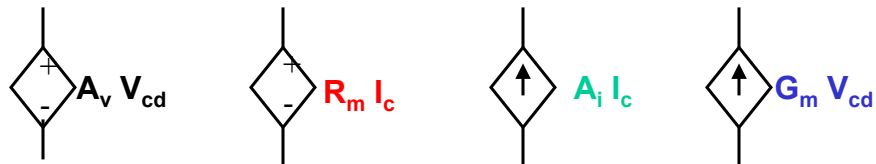

**WHY DEPENDENT SOURCES?
EXAMPLE: MODEL FOR AN AMPLIFIER**

AMPLIFIER SYMBOL

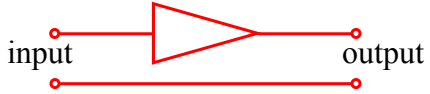

Differential Amplifier

$$V_0 = A(V_+ - V_-)$$

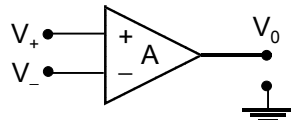

V_0 depends only on input $(V_+ - V_-)$.

EXAMPLE: $A = 20$ Then if input $(V_+ - V_-) = 10\text{mV}$; $V_0 = 200\text{mV}$.

An actual amplifier has dozens (to hundreds) of devices (transistors) in it. But the dependent source allows us to model it with a very simple element.

**EXAMPLE OF THE USE OF DEPENDENT SOURCE
IN THE MODEL FOR AN AMPLIFIER**

AMPLIFIER SYMBOL

Differential Amplifier

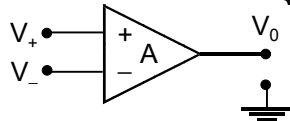

AMPLIFIER MODEL

Circuit Model *in linear region*

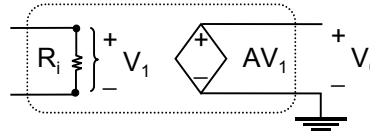

V_0 depends only on input $(V_+ - V_-)$

See the utility of this: this Model when used correctly mimics the behavior of an amplifier but omits the complication of the many many transistors and other components.

OP-AMP AND USE OF FEEDBACK

A very high-gain differential amplifier can function in an extremely linear fashion as an operational amplifier by using negative feedback.

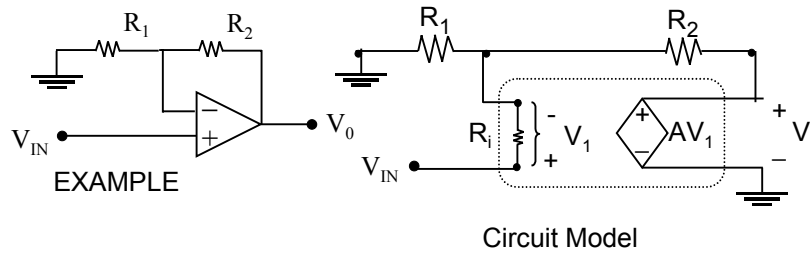

Negative feedback \Rightarrow **Stabilizes** the output

We can show that that for $A \rightarrow \infty$ and $R_i \rightarrow \infty$,

$$V_0 \cong V_{IN} \cdot \frac{R_1 + R_2}{R_1} \quad \text{Stable, finite, and independent of the properties of the OP AMP!}$$

IDEAL OP-AMPS ANALYSIS TECHNIQUE

Assumption 1: The **potential** between the op-amp input terminals, $v_{(+)} - v_{(-)}$, equals **zero**.

Assumption 2: The **currents** flowing into the op-amp's two input terminals both equal **zero**.

No Currents

No Potential Difference

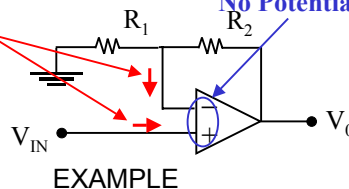

IDEAL OP-AMPS ANALYSIS EXAMPLE #1

Assumption 1: The potential between the op-amp input terminals, $v_{(+)} - v_{(-)}$, equals zero.

Assumption 2: The currents flowing into the op-amp's two input terminals both equal zero.

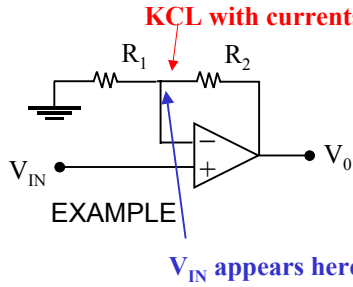

$$\frac{v_{in}}{R_1} + \frac{v_{in} - v_{out}}{R_2} = 0$$

$$v_{out} = \frac{R_1 + R_2}{R_1} v_{in}$$

Non-inverting Amplifier

IDEAL OP-AMPS ANALYSIS EXAMPLE #2

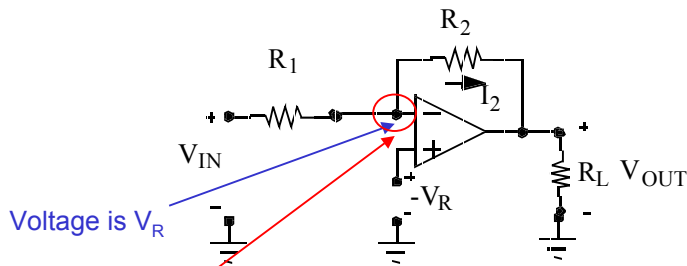

$$\frac{V_R - V_{IN}}{R_1} + \frac{V_R - V_{OUT}}{R_2} = 0$$

$$V_{OUT} = V_R - \frac{R_2}{R_1} (V_{in} - V_R)$$

Inverting Amplifier with reference voltage

THE RAILS

The output voltage of an amplifier is of course limited by whatever voltages are supplied (the “power supplies”). Sometimes we show them explicitly on the amplifier diagram, but often they are left off.

Differential Amplifier

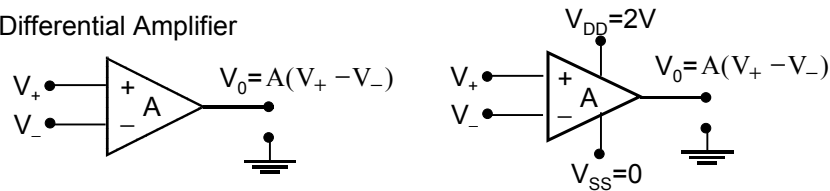

If the supplies are 2V and 0V, the output cannot swing beyond these values. (You should try this experiment in the lab.) So in this case we have upper rail = 2V, lower rail = 0V.

The rails cannot be larger than the supply voltages. *For simplicity we will use the supply voltages as the rails.*