

Welcome to EECS 16A!

Designing Information Devices and Systems I

Ana Arias and Miki Lustig



2022

Lecture 13A
Least Squares Apps



Example 5: Exponential Regression

Model: $y = ce^{ax}$

Q: Is this a linear fit?

A: No! But, can be made linear.....

New Model: $\log(y) = \log c + ax = b + ax$

Knowns: $(x_1, \log(y_1)) (x_2, \log(y_2)) \dots (x_N, \log(y_N))$

Unknowns: $\vec{p} = [a \ b]^T$

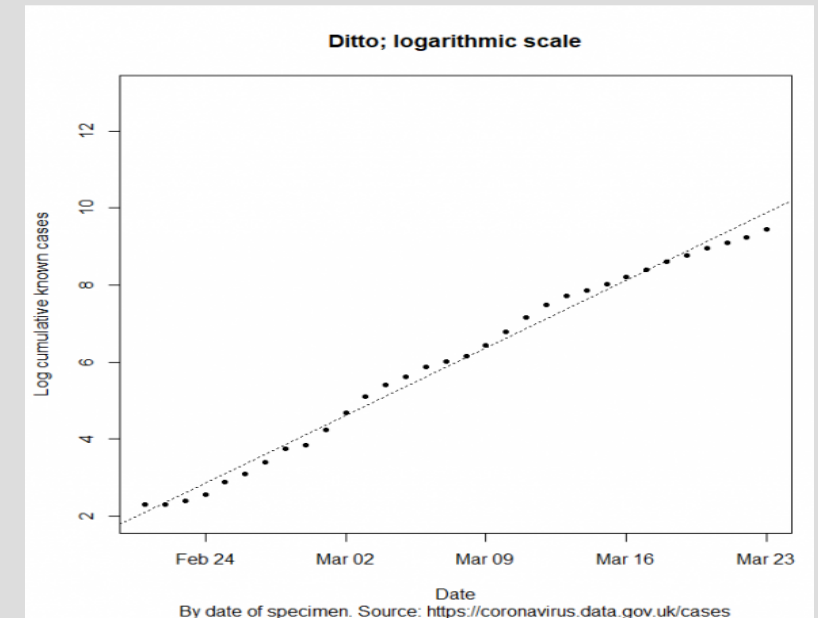
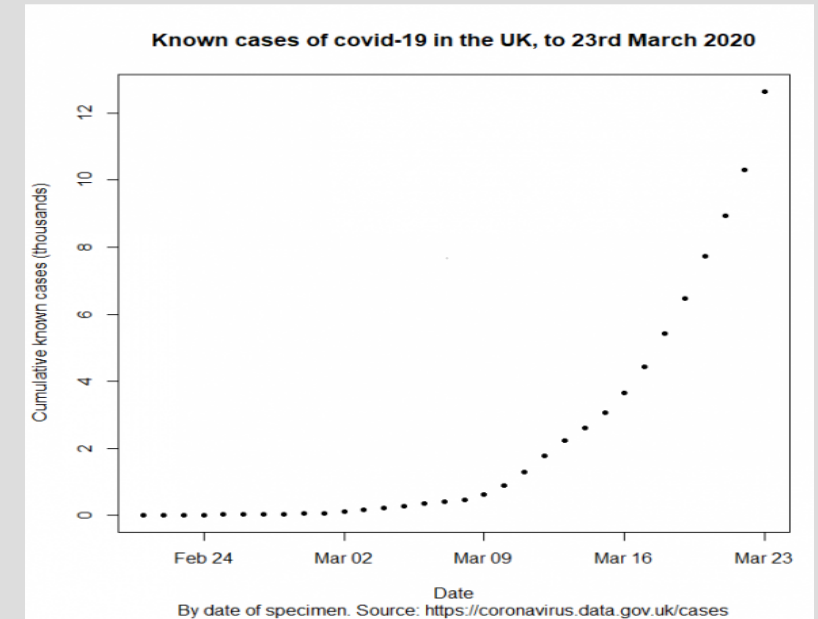
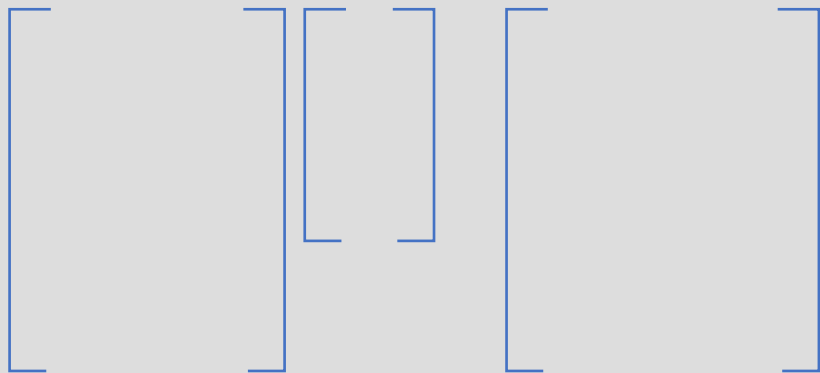

Example 5: Exponential Regression

Model: $y = ce^{ax}$

Q: Is this a linear fit?

A: No! But, can be made linear.....

New Model: $\log(y) = \log c + ax = b + ax$

Knowns: $(x_1, \log(y_1)) (x_2, \log(y_2)) \dots (x_N, \log(y_N))$

Unknowns: $\vec{p} = [a \ b]^T$

$$\begin{bmatrix} A & \vec{p} \\ \begin{matrix} x_1 & 1 \\ x_2 & 1 \\ \vdots & \vdots \\ x_N & 1 \end{matrix} & \begin{bmatrix} a \\ b \end{bmatrix} \\ = & \begin{bmatrix} \vec{y} \\ \log y_1 \\ \log y_2 \\ \vdots \\ \log y_N \end{bmatrix} \end{bmatrix}$$

$$\hat{p} = (A^T A)^{-1} A^T \vec{y}$$

$$\hat{c} = e^{\hat{b}}$$

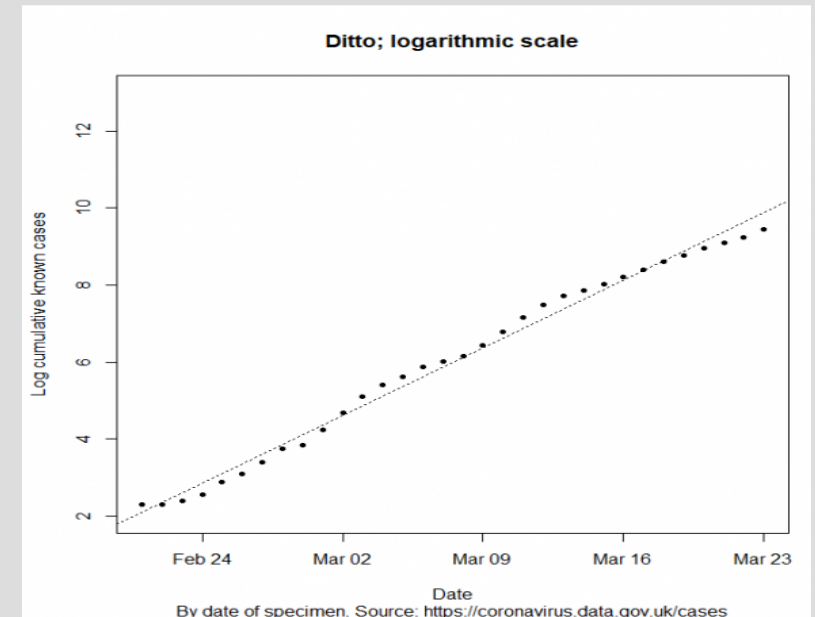
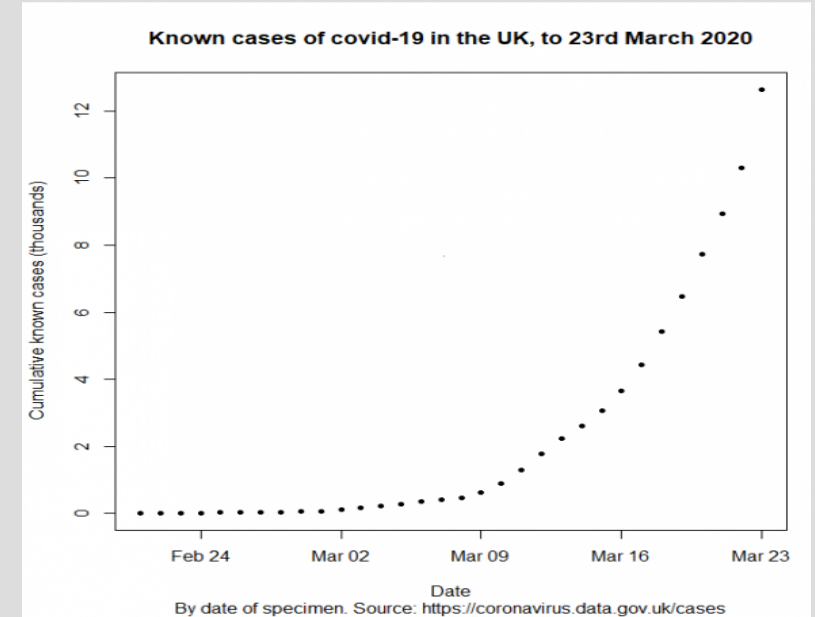

Example 6: Over Fitting

- Consider noisy measurements of $y = 0.1x + 1$:

Model: $y = ax + b$

$$\vec{p} = [0.1015 \quad 0.9757]^T$$

$$\|\vec{e}\| = 3.85$$

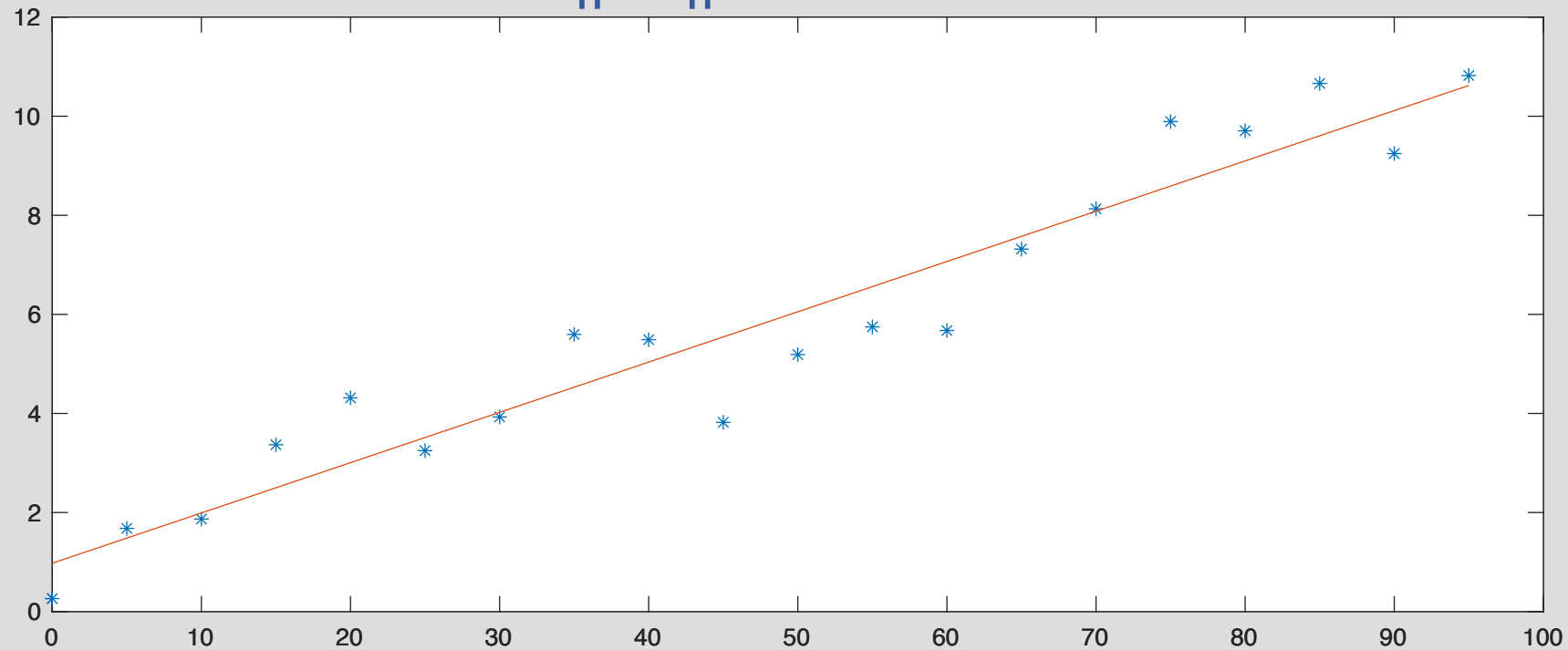

Example 6: Over Fitting

- Consider noisy measurements of $y = 0.1x + 1$:

Model: $y = ax^3 + bx^2 + cx + d$

$$\|\vec{e}\| = 3.71$$

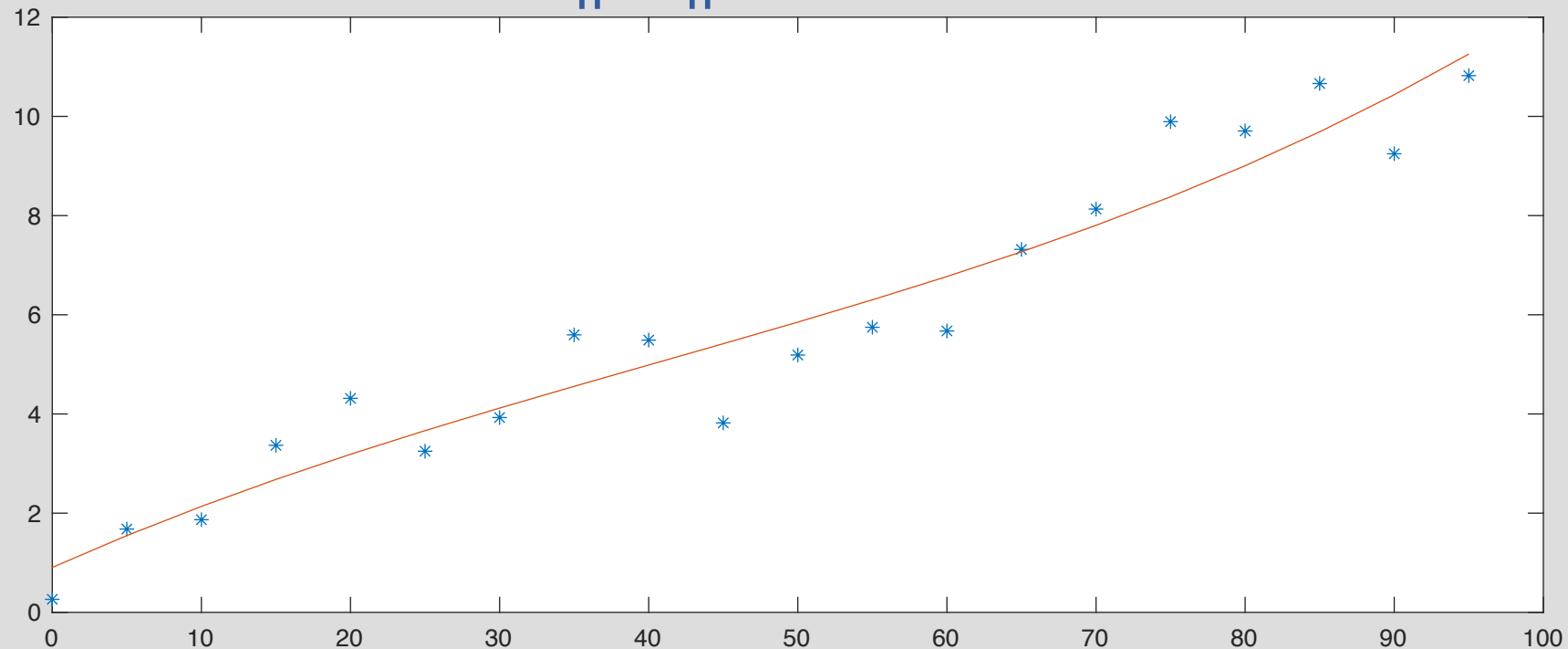

Example 6: Over Fitting

- Consider noisy measurements of $y = 0.1x + 1$:

Model: $y = ax^7 + bx^6 + cx^5 + dx^4 + ex^3 + fx^2 + gx + h$

$$\|\vec{e}\| = 2.42$$

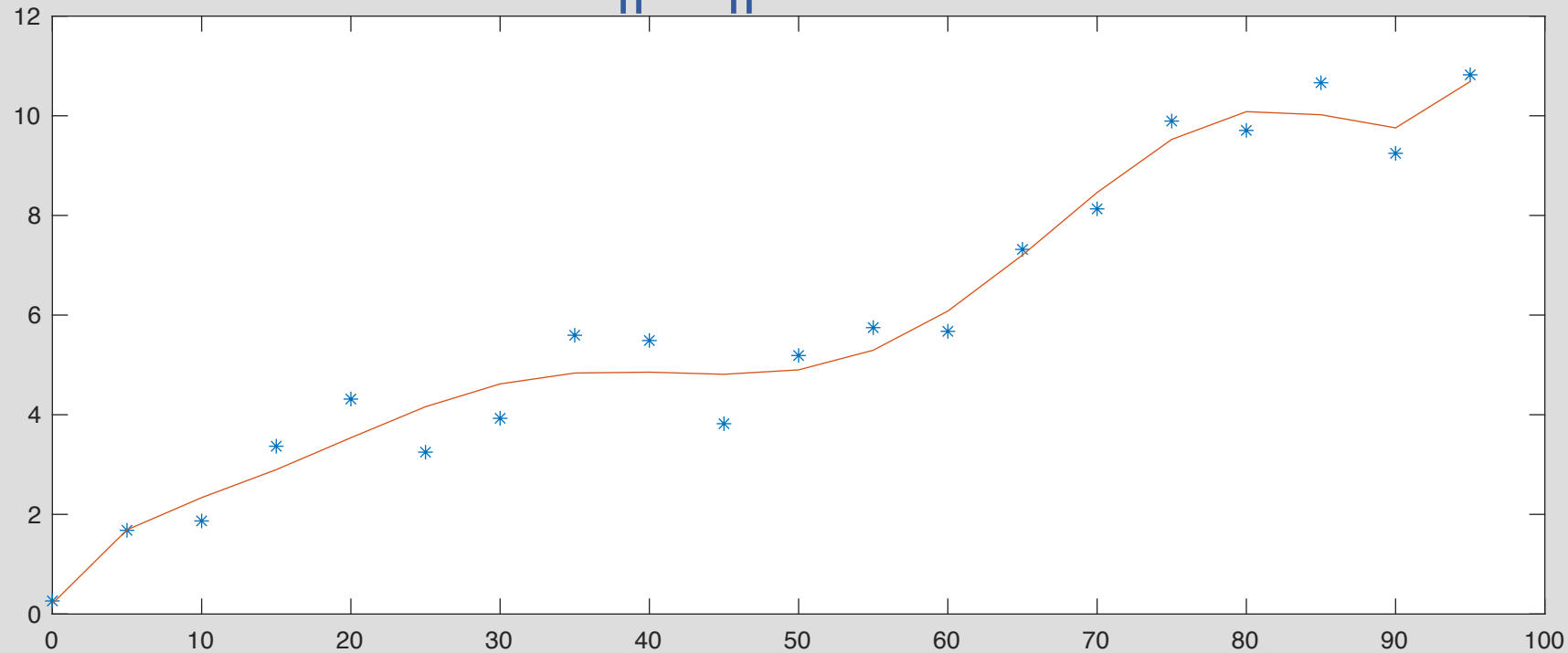

Example 6: Model Order Selection

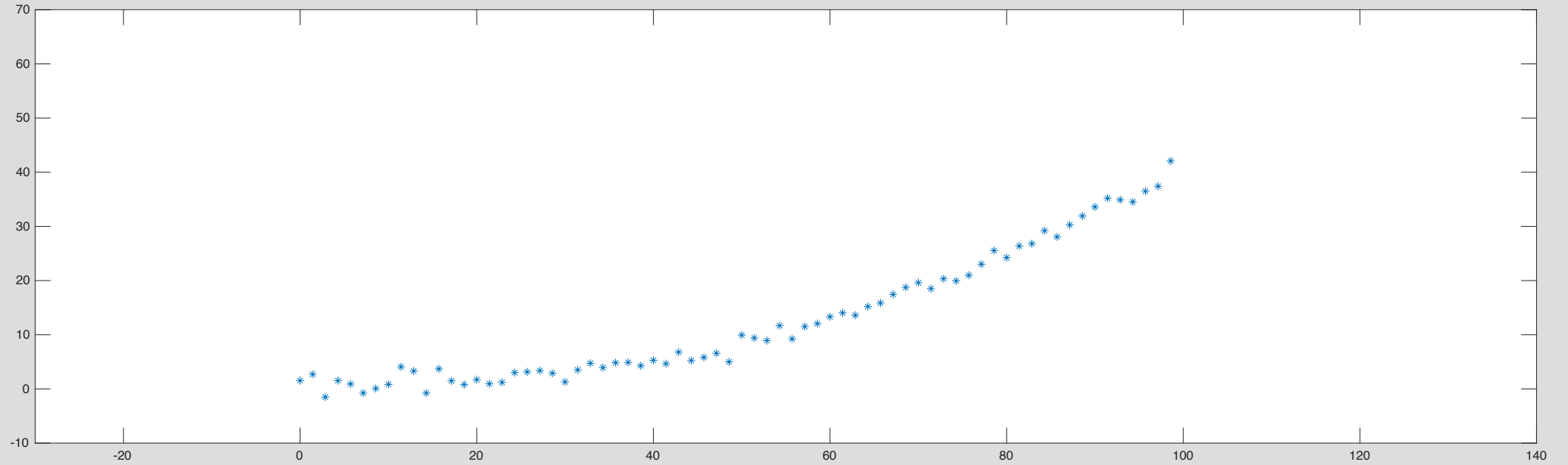

Example 6: Model Order Selection

Model: $y = ax + b$

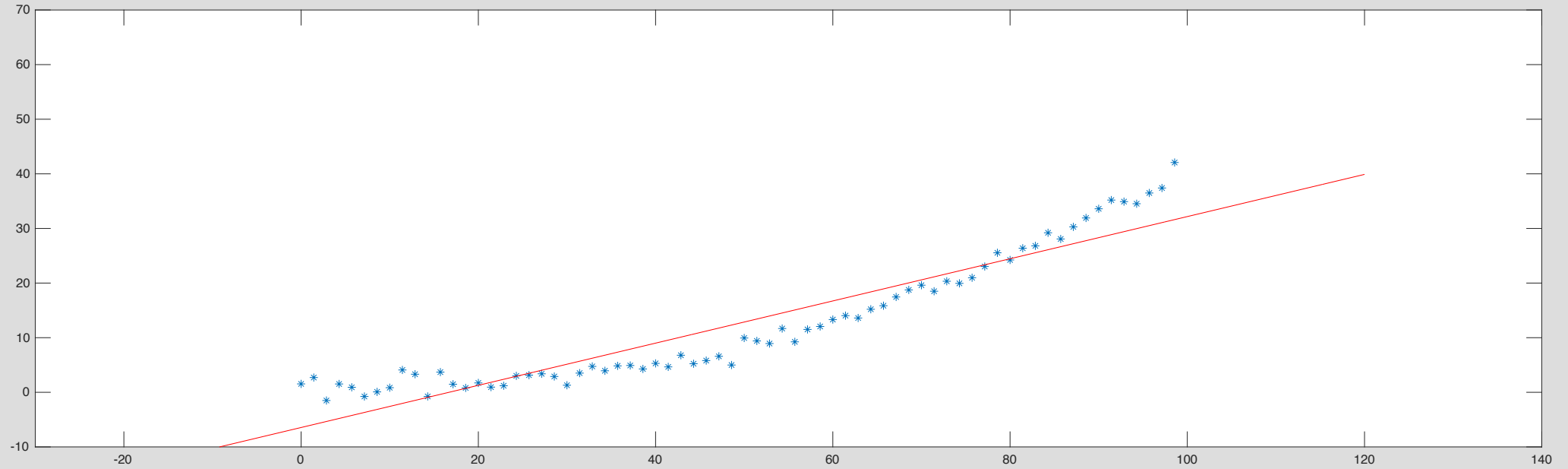

Example 6: Model Order Selection

Model: $y = ax^2 + bx + c$

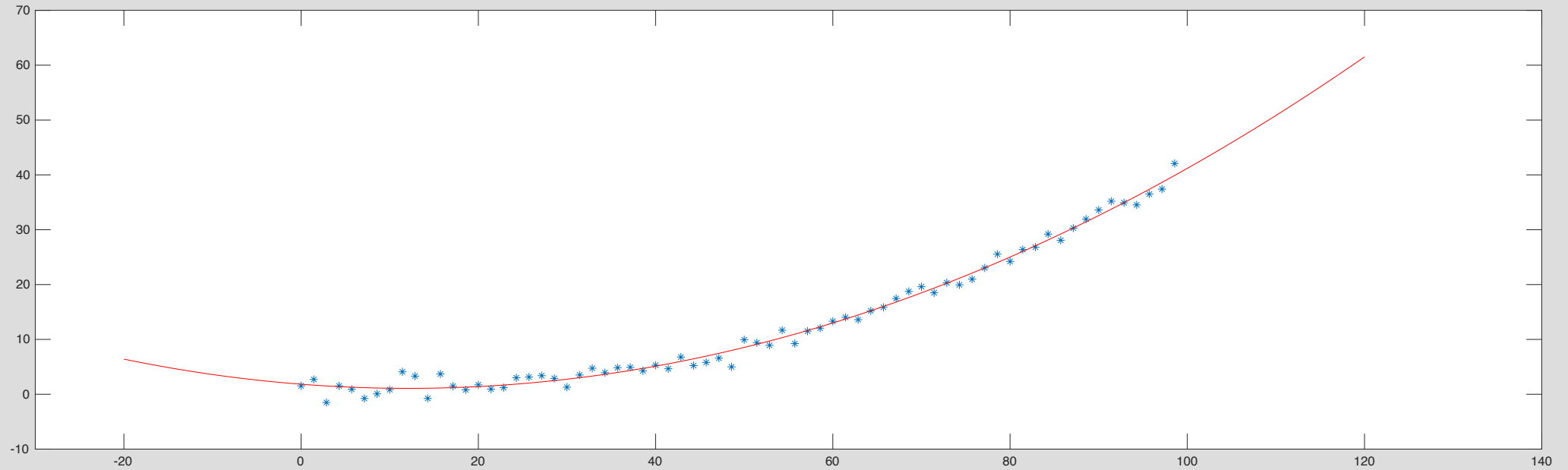

Example 6: Model Order Selection

Model: $y = ax^{10} + bx^9 + cx^8 + dx^7 + ex^6 + fx^5 + gx^4 + hx^3 + ix^2 + jx + k$

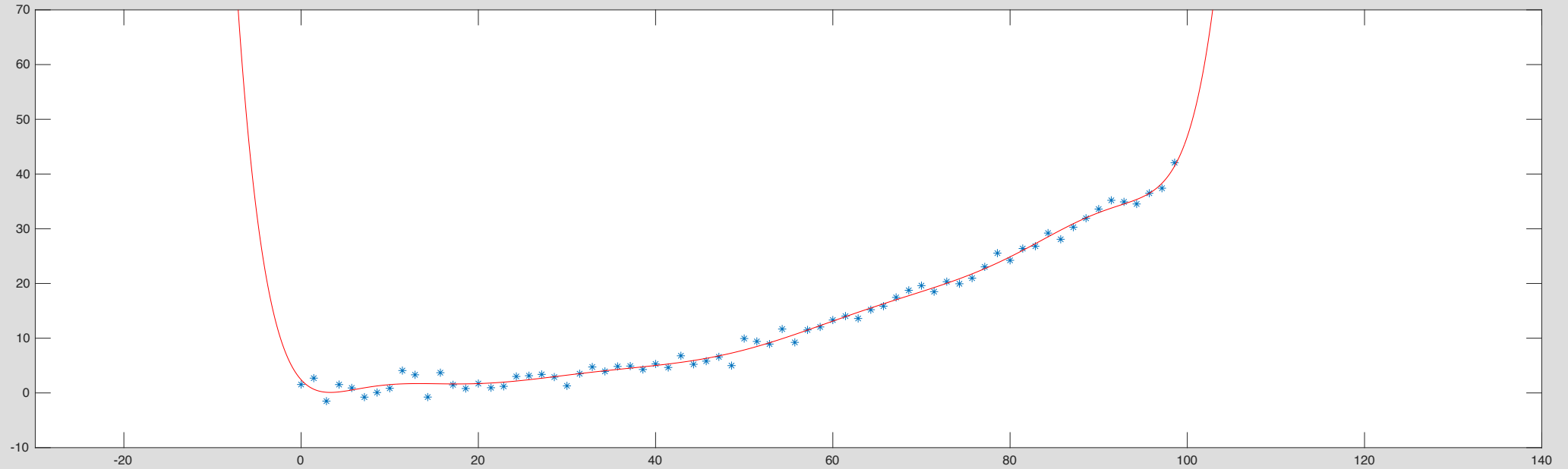

Example 6: Model Order Selection

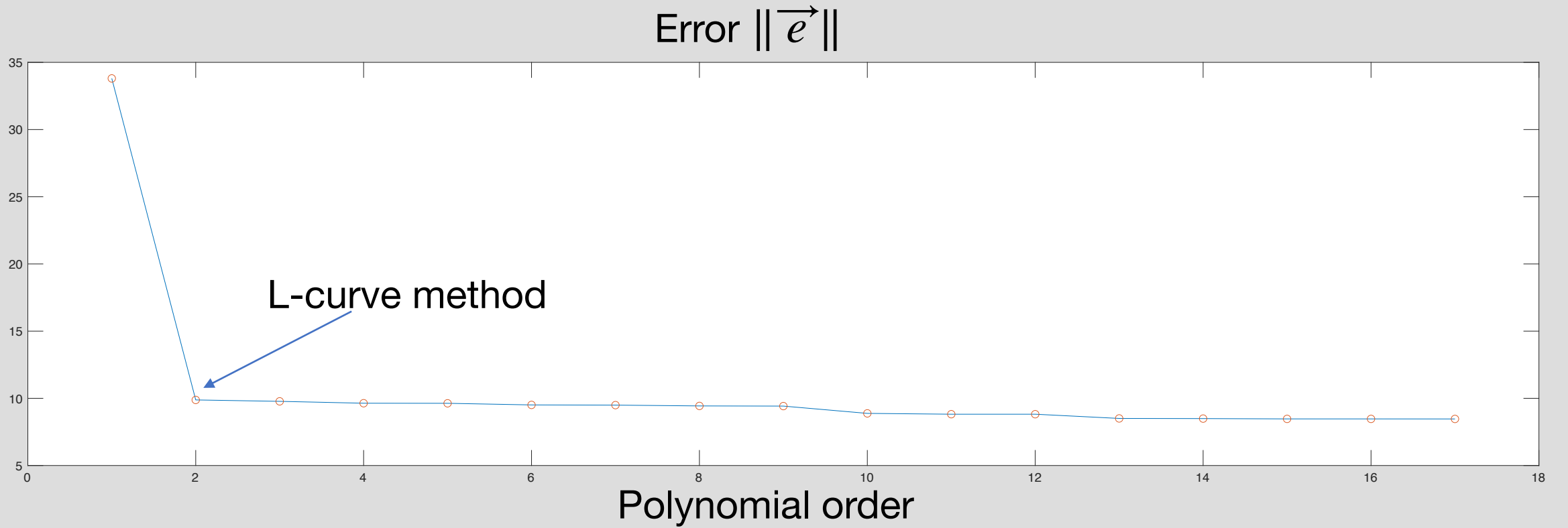

Example 6: Model Order Selection

Split data into training / test sets

Fit model on training set

Evaluate error on test set

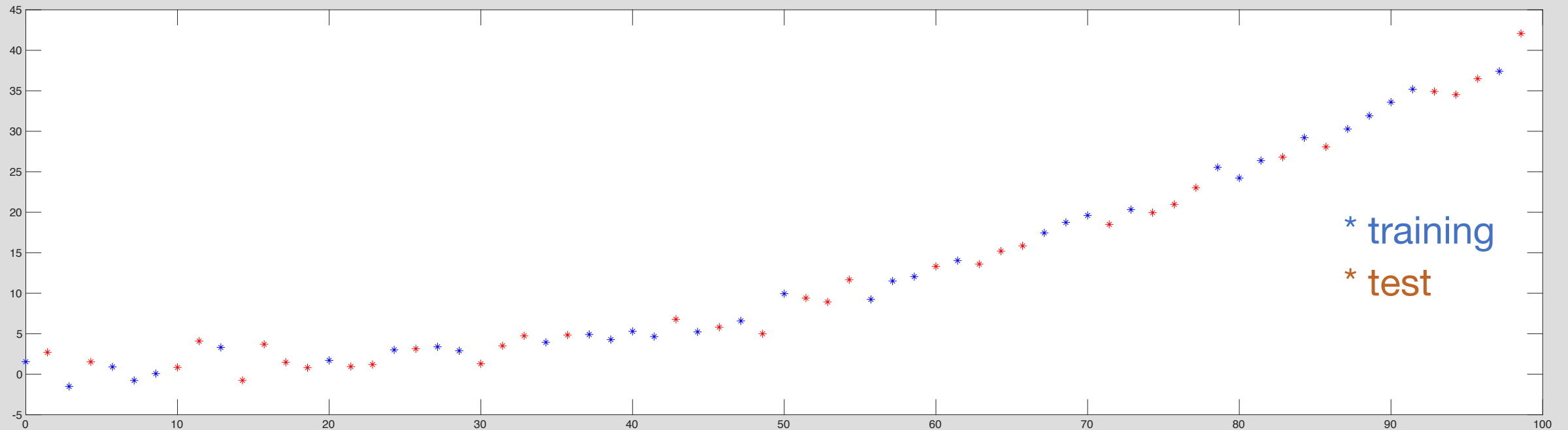

Example 6: Model Order Selection

Split data into training / test sets

Fit model on training set

Evaluate error on test set

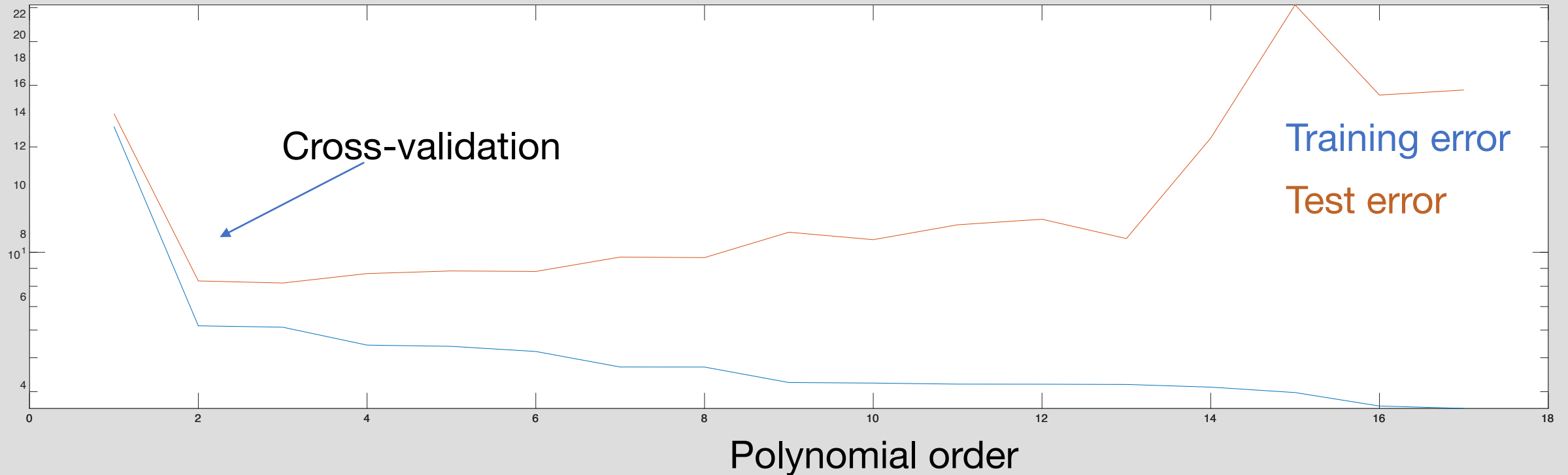

Example 7: Outlier

Model: $y = ax + b$

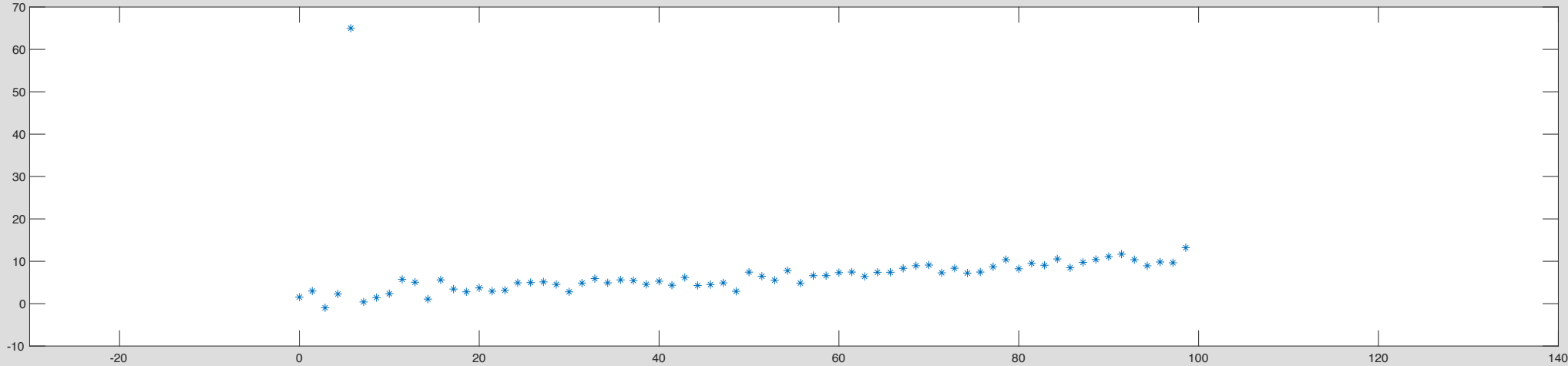

Example 7: Outlier

Model: $y = ax + b$

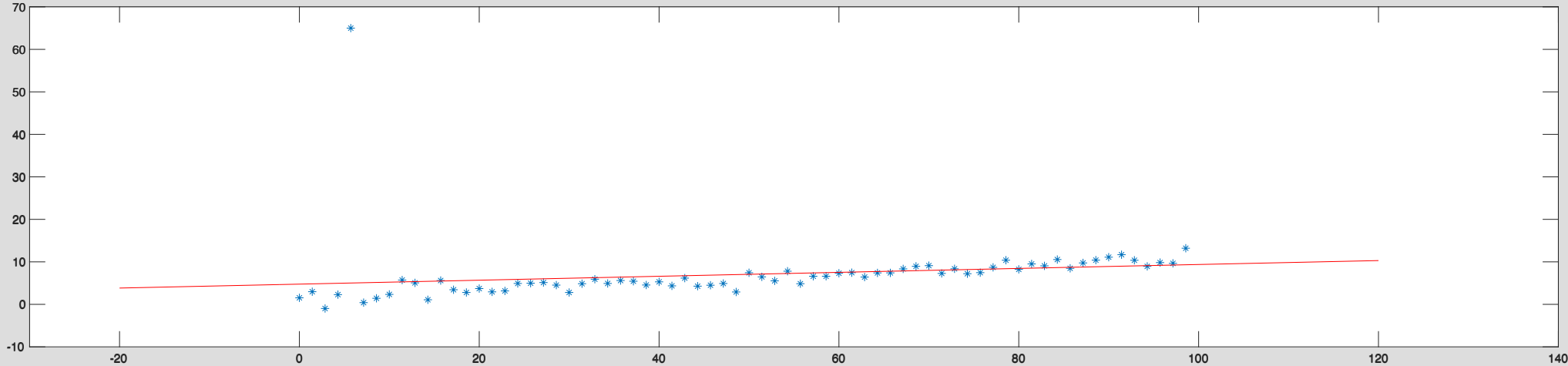

Example 7: Outlier

Model: $y = ax + b$

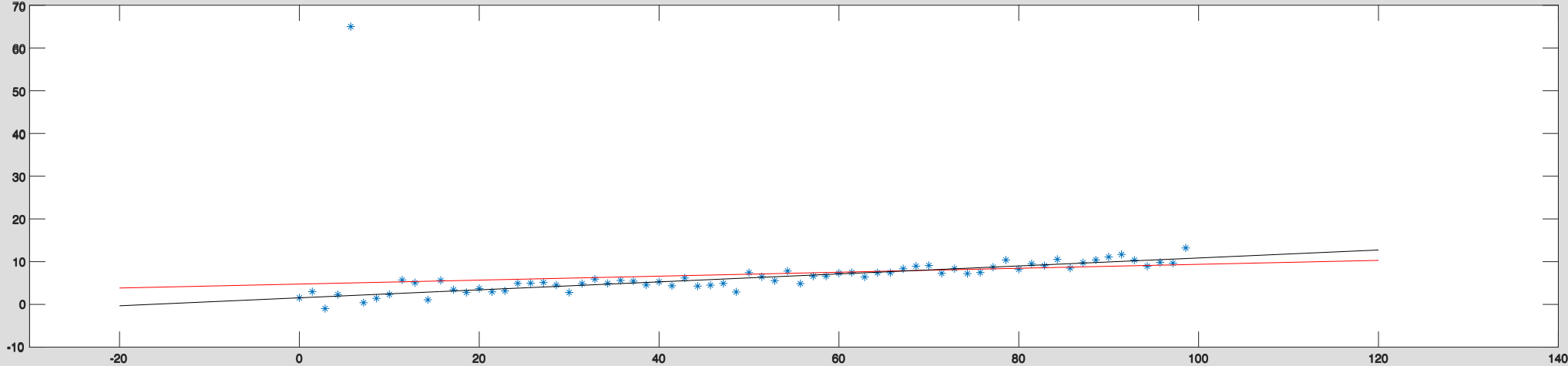

Multi-Lateration

$$2(\vec{a}_1 - \vec{a}_2)^T \vec{x} - 2C^2 \Delta\tau_2 \tau_1 = \|\vec{a}_1\|^2 - \|\vec{a}_2\|^2 + C^2(\Delta\tau_2)^2$$

$$2(\vec{a}_1 - \vec{a}_3)^T \vec{x} - 2C^2 \Delta\tau_3 \tau_1 = \|\vec{a}_1\|^2 - \|\vec{a}_3\|^2 + C^2(\Delta\tau_3)^2$$

$$2(\vec{a}_1 - \vec{a}_4)^T \vec{x} - 2C^2 \Delta\tau_4 \tau_1 = \|\vec{a}_1\|^2 - \|\vec{a}_4\|^2 + C^2(\Delta\tau_4)^2$$

$$2(\vec{a}_1 - \vec{a}_5)^T \vec{x} - 2C^2 \Delta\tau_5 \tau_1 = \|\vec{a}_1\|^2 - \|\vec{a}_5\|^2 + C^2(\Delta\tau_5)^2$$

More equations than unknowns

$$\begin{matrix} \boxed{A} \\ \vec{p} \end{matrix} = \begin{matrix} \vec{b} \end{matrix}$$

Over-determined — Solve via Least-Squares

Q: How do we know if $A^T A$ is invertible?

A: if A is full rank!?!?

$$\hat{p} = (A^T A)^{-1} A^T \vec{y}$$

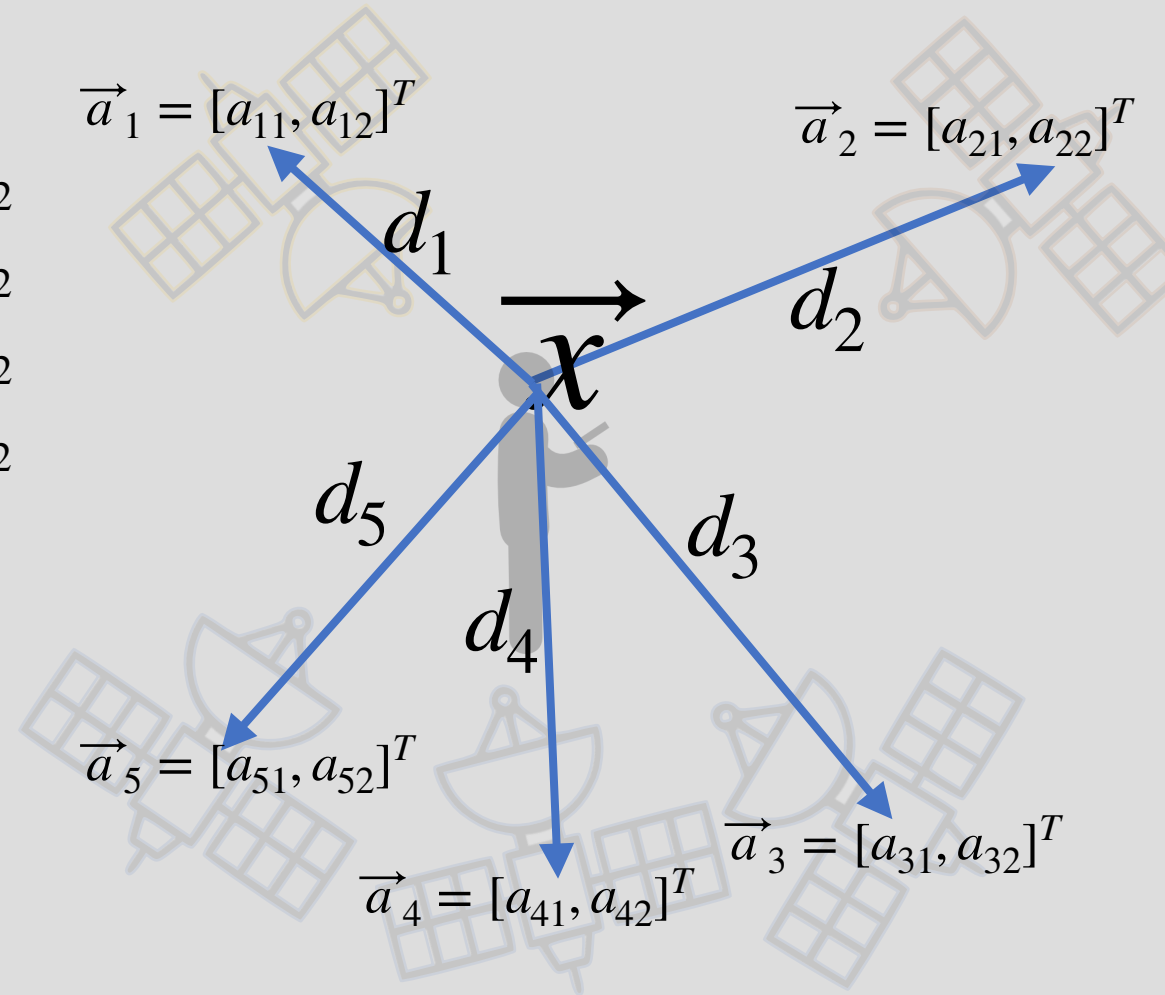

Matrix Transposes

$$(AB)^T \left(\begin{array}{|c|c|} \hline \color{red}{M} & \color{red}{L} \\ \hline \color{blue}{N} & \color{blue}{M} \\ \hline \end{array} \right)^T = \left(\begin{array}{|c|} \hline \color{red}{L} \\ \hline \color{blue}{N} \\ \hline \end{array} \right)^T \in \mathbb{R}^{L \times N} \quad \begin{array}{|c|} \hline \color{red}{N} \\ \hline \color{blue}{L} \\ \hline \end{array}$$

$$B^T A^T \begin{array}{|c|c|} \hline \color{red}{L} & \color{red}{M} \\ \hline \color{blue}{M} & \color{blue}{N} \\ \hline \end{array} \in \mathbb{R}^{L \times N} \quad \begin{array}{|c|} \hline \color{red}{N} \\ \hline \color{blue}{L} \\ \hline \end{array}$$

$$(AB)^T = B^T A^T$$

Invertibility of $A^T A$

- Invertible \Rightarrow Trivial null space \Rightarrow Linear independent cols/rows....

The matrix $A^T A$ is invertible iff $\text{Null}(A^T A) = \vec{0}$

Theorem: $\text{Null}(A^T A) = \text{Null}(A)$

Proof: (1) show that if $\vec{w} \in \text{Null}(A)$, then $\vec{w} \in \text{Null}(A^T A)$
(2) show that if $\vec{v} \in \text{Null}(A^T A)$, then $\vec{v} \in \text{Null}(A)$

$$\begin{aligned} (1). \quad & \vec{w} \in \text{Null}(A) \\ & A\vec{w} = \vec{0} \\ & A^T A\vec{w} = A^T \vec{0} \\ & A^T A\vec{w} = \vec{0} \quad \checkmark \end{aligned}$$

$$\begin{aligned} (2). \quad & \vec{v} \in \text{Null}(A^T A) \\ & A^T A\vec{v} = \vec{0} \quad \text{Need to show } A\vec{v} = \vec{0} \\ & \quad \text{Or... } \|A\vec{v}\| = 0 \\ & \|A\vec{v}\|^2 = (A\vec{v})^T (A\vec{v}) \\ & \quad = \vec{v}^T A^T (A\vec{v}) \\ & \quad = \vec{v}^T (A^T A\vec{v}) = 0 \quad \checkmark \end{aligned}$$

Back to GPS

$$\vec{a}_1 = [0, 0]^T$$

$$\vec{a}_2 = [2, 1]^T$$

$$\vec{a}_3 = [4, 2]^T$$

$$\vec{a}_4 = [6, 3]^T$$

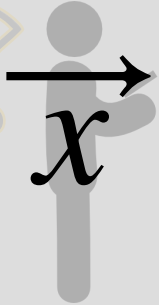

$$\begin{bmatrix} \\ \\ \\ \end{bmatrix} \begin{bmatrix} \\ \\ \\ \end{bmatrix} = \begin{bmatrix} \\ \\ \\ \end{bmatrix}$$

Back to GPS

$$\vec{a}_1 = [0, 0]^T$$

$$\vec{a}_2 = [2, 1]^T$$

$$\vec{a}_3 = [4, 2]^T$$

$$\vec{a}_4 = [6, 3]^T$$

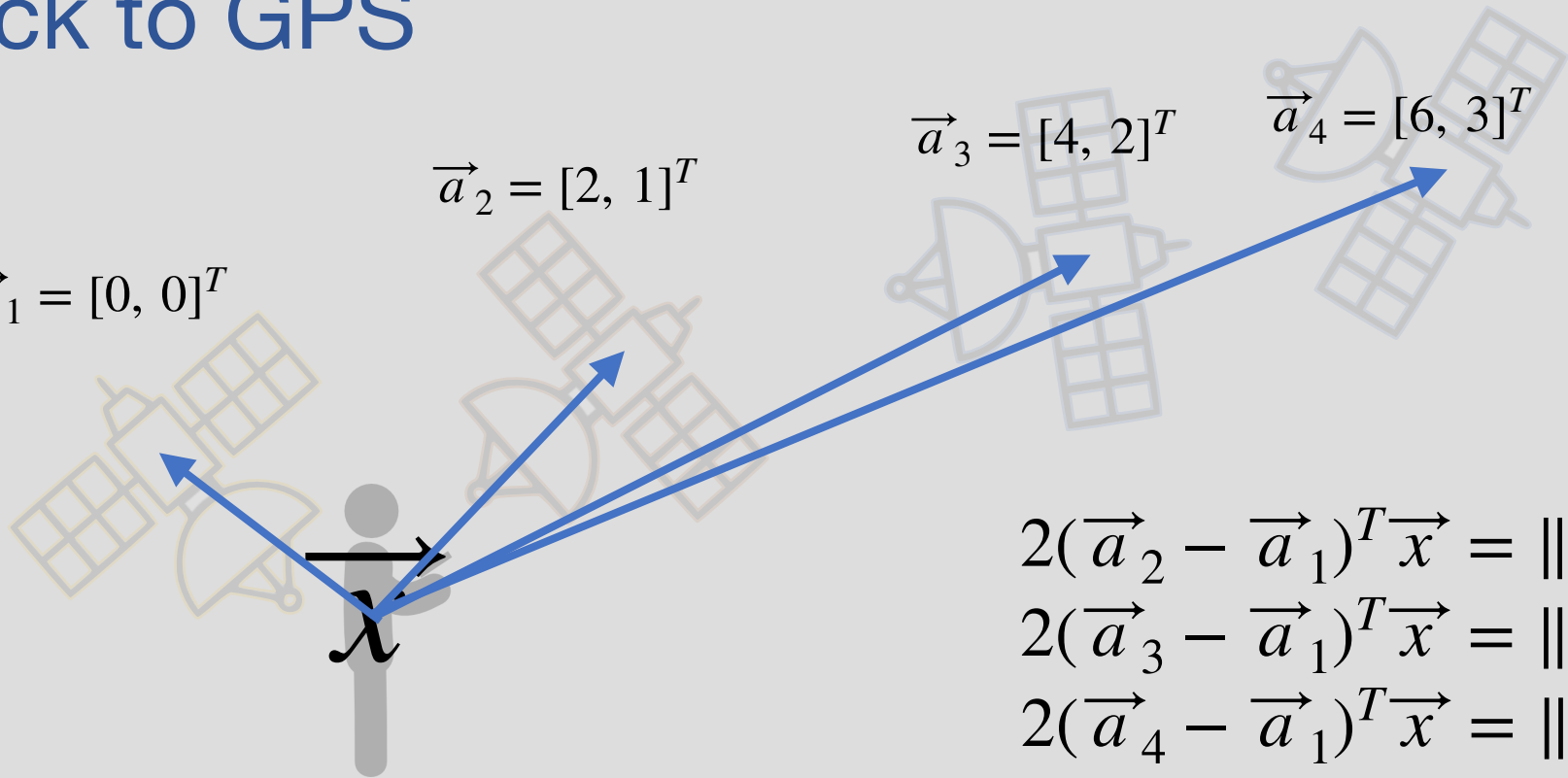

$$2(\vec{a}_2 - \vec{a}_1)^T \vec{x} = \|\vec{a}_2\|^2 - \|\vec{a}_1\|^2 + d_1^2 - d_2^2$$

$$2(\vec{a}_3 - \vec{a}_1)^T \vec{x} = \|\vec{a}_3\|^2 - \|\vec{a}_1\|^2 + d_1^2 - d_3^2$$

$$2(\vec{a}_4 - \vec{a}_1)^T \vec{x} = \|\vec{a}_4\|^2 - \|\vec{a}_1\|^2 + d_1^2 - d_4^2$$

$$\begin{bmatrix} 2(\vec{a}_2 - \vec{a}_1)^T \\ 2(\vec{a}_3 - \vec{a}_1)^T \\ 2(\vec{a}_4 - \vec{a}_1)^T \end{bmatrix} \vec{x} = \begin{bmatrix} \|\vec{a}_2\|^2 - \|\vec{a}_1\|^2 + d_1^2 - d_2^2 \\ \|\vec{a}_3\|^2 - \|\vec{a}_1\|^2 + d_1^2 - d_3^2 \\ \|\vec{a}_4\|^2 - \|\vec{a}_1\|^2 + d_1^2 - d_4^2 \end{bmatrix}$$

Back to GPS

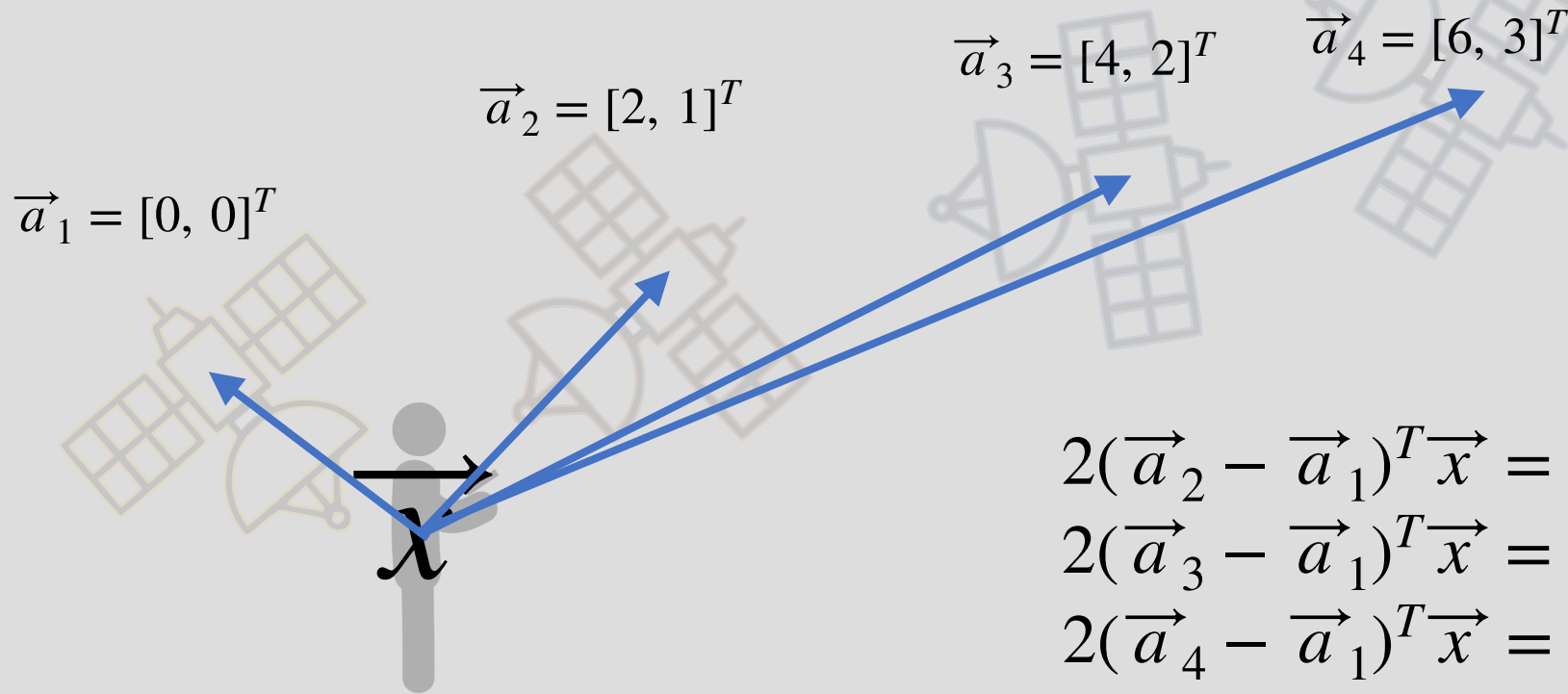

$$2(\vec{a}_2 - \vec{a}_1)^T \vec{x} = \|\vec{a}_2\|^2 - \|\vec{a}_1\|^2 + d_1^2 - d_2^2$$

$$2(\vec{a}_3 - \vec{a}_1)^T \vec{x} = \|\vec{a}_3\|^2 - \|\vec{a}_1\|^2 + d_1^2 - d_3^2$$

$$2(\vec{a}_4 - \vec{a}_1)^T \vec{x} = \|\vec{a}_4\|^2 - \|\vec{a}_1\|^2 + d_1^2 - d_4^2$$

$$\begin{bmatrix} 4 & 2 \\ 8 & 4 \\ 12 & 6 \end{bmatrix} \begin{bmatrix} x_1 \\ x_2 \end{bmatrix} = \begin{bmatrix} \|\vec{a}_2\|^2 + d_1^2 - d_2^2 \\ \|\vec{a}_3\|^2 + d_1^2 - d_3^2 \\ \|\vec{a}_4\|^2 + d_1^2 - d_4^2 \end{bmatrix}$$

Back to GPS

$$\begin{bmatrix} 4 \\ 8 \\ 12 \end{bmatrix} \begin{bmatrix} 2 \\ 4 \\ 6 \end{bmatrix} \begin{bmatrix} x_1 \\ x_2 \end{bmatrix} = \begin{bmatrix} \|\vec{a}_2\|^2 + d_1^2 - d_2^2 \\ \|\vec{a}_3\|^2 + d_1^2 - d_3^2 \\ \|\vec{a}_4\|^2 + d_1^2 - d_4^2 \end{bmatrix}$$

$$\begin{bmatrix} 4 & 8 & 12 \\ 2 & 4 & 6 \end{bmatrix} \begin{bmatrix} 4 \\ 8 \\ 12 \end{bmatrix} \begin{bmatrix} 2 \\ 4 \\ 6 \end{bmatrix} = \begin{bmatrix} \phantom{\|\vec{a}_2\|^2 + d_1^2 - d_2^2} \\ \phantom{\|\vec{a}_3\|^2 + d_1^2 - d_3^2} \\ \phantom{\|\vec{a}_4\|^2 + d_1^2 - d_4^2} \end{bmatrix}$$

Back to GPS

$$\begin{bmatrix} 4 & 2 \\ 8 & 4 \\ 12 & 6 \end{bmatrix} \begin{bmatrix} x_1 \\ x_2 \end{bmatrix} = \begin{bmatrix} \|\vec{a}_2\|^2 + d_1^2 - d_2^2 \\ \|\vec{a}_3\|^2 + d_1^2 - d_3^2 \\ \|\vec{a}_4\|^2 + d_1^2 - d_4^2 \end{bmatrix}$$

$$\begin{bmatrix} 4 & 8 & 12 \\ 2 & 4 & 6 \end{bmatrix} \begin{bmatrix} 4 & 2 \\ 8 & 4 \\ 12 & 6 \end{bmatrix} = \begin{bmatrix} 224 & 112 \\ 112 & 56 \end{bmatrix}$$

Back to GPS

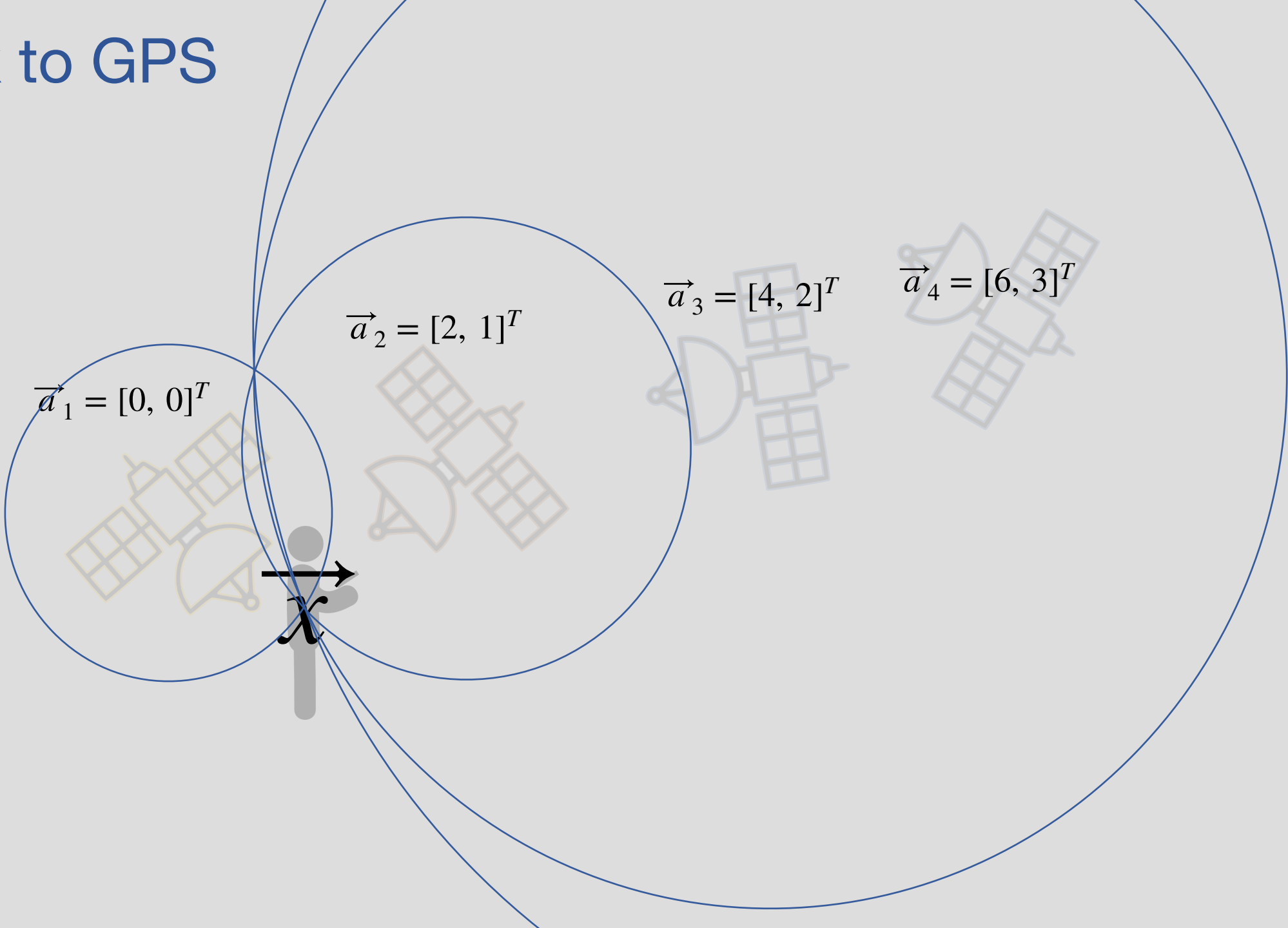

Invertibility of $A^T A$

- What if $A^T A$ is not invertible

$$A^T A \hat{x} = A^T \vec{b}$$

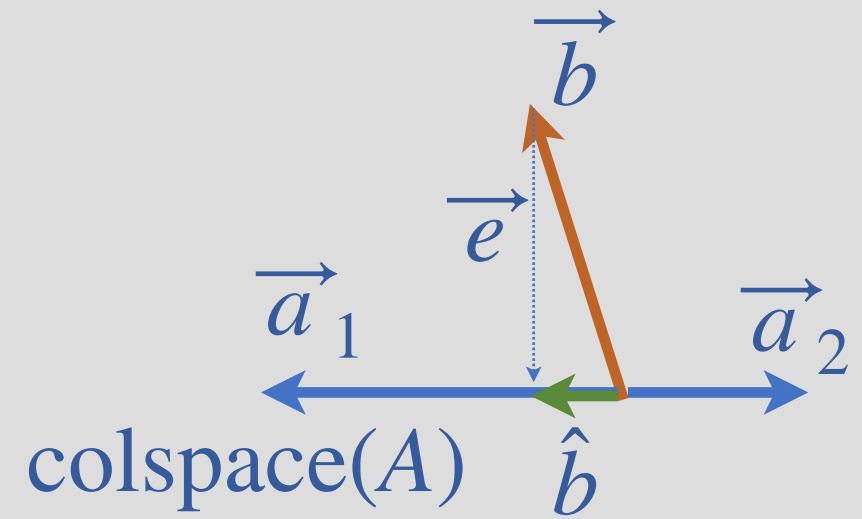

A: \hat{x} will have infinite solutions with the same $\vec{e} = A\hat{x} - \vec{b}$

Resistive Pulse Sensing

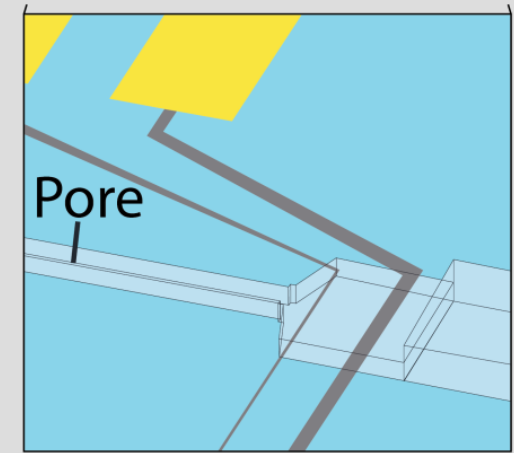
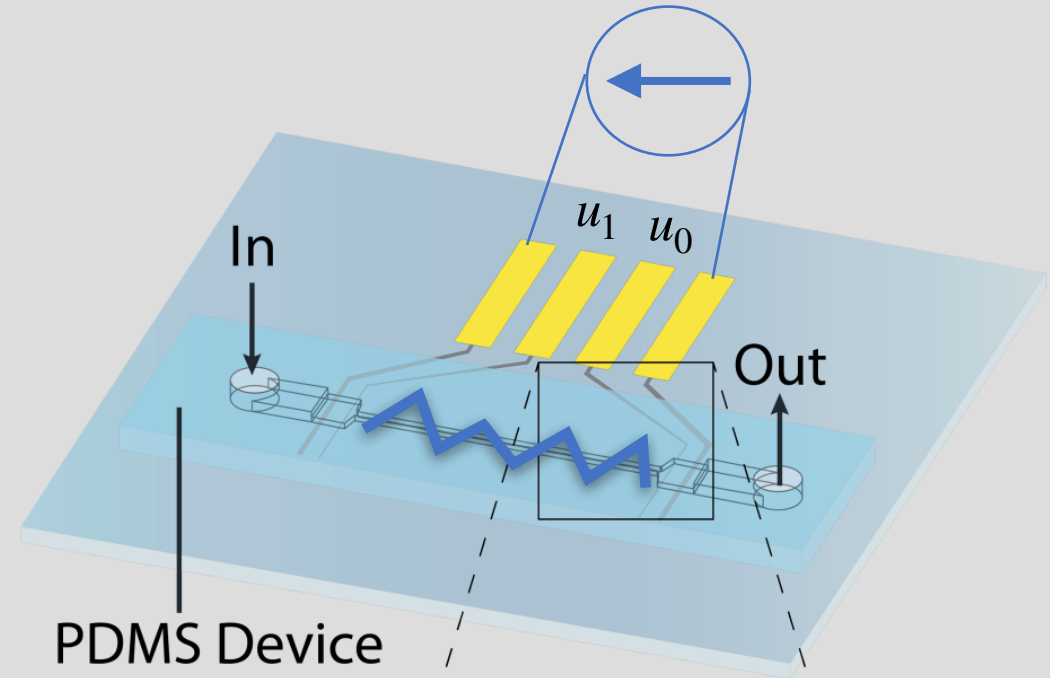
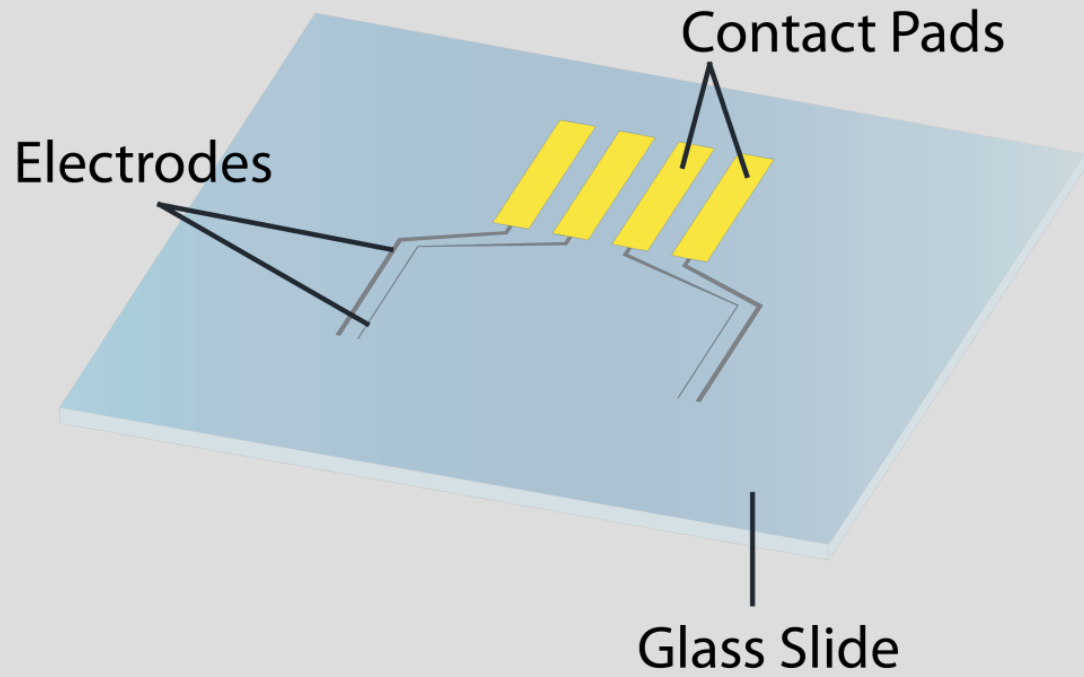

Prof. Lydia Sohn M.E.



Resistive Pulse Sensing

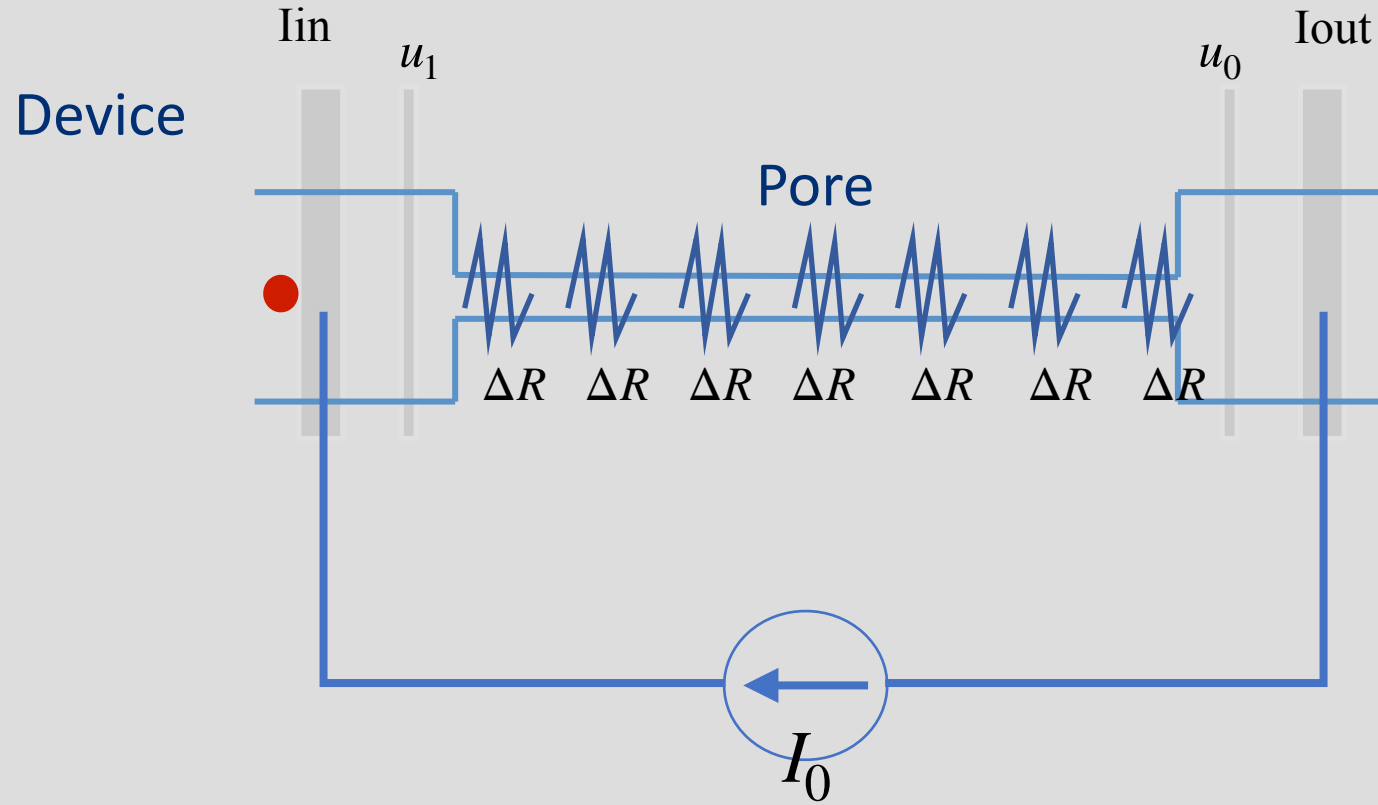

$$u_1 - u_0 = I_0 R$$

Resistive Pulse Sensing

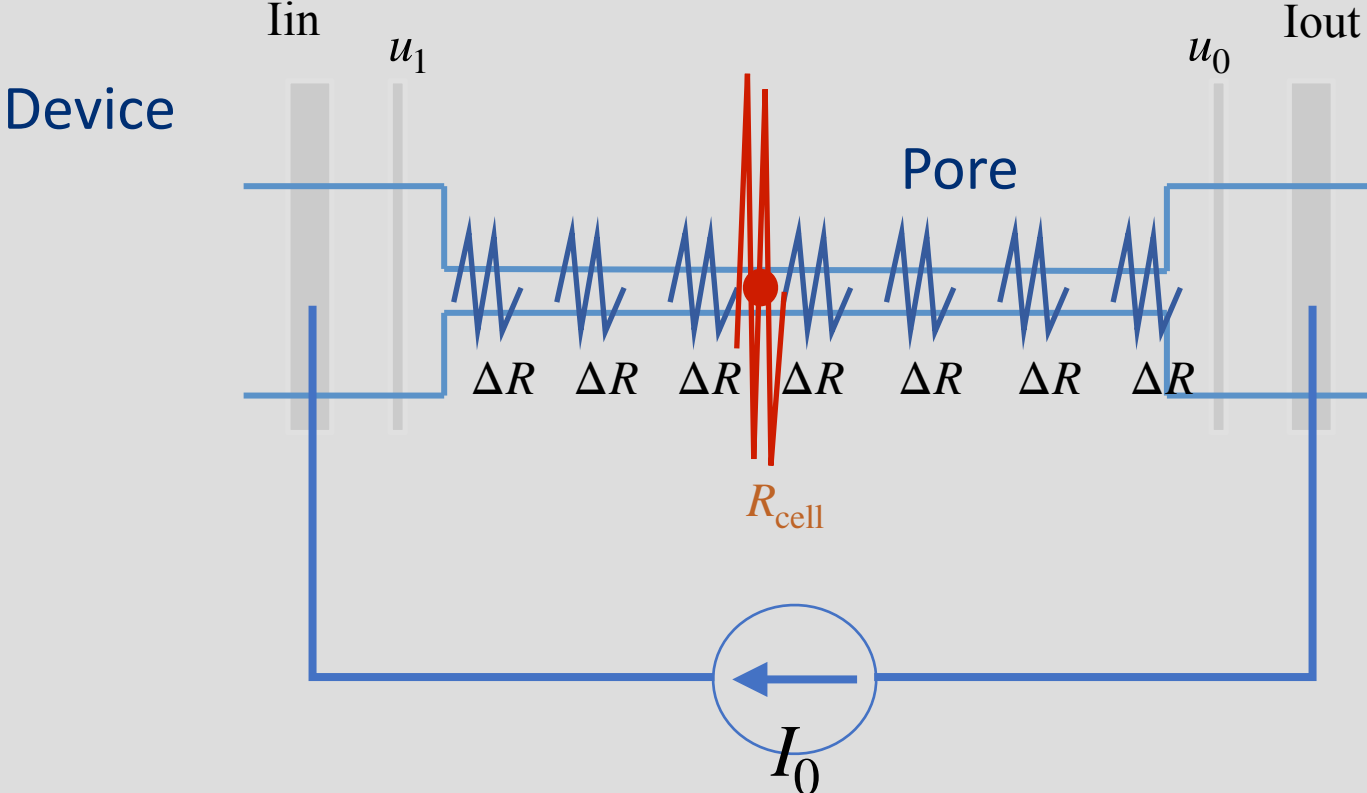

$$u_1 - u_0 = I_0 R$$

Resistive Pulse Sensing

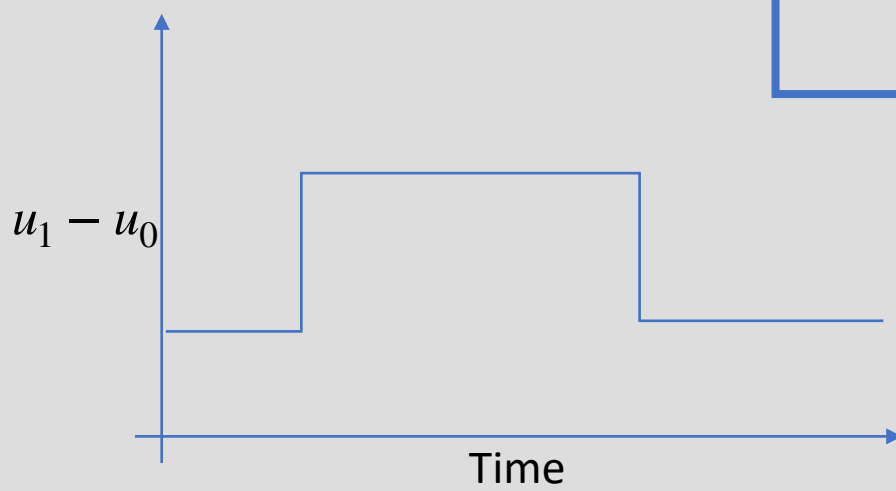
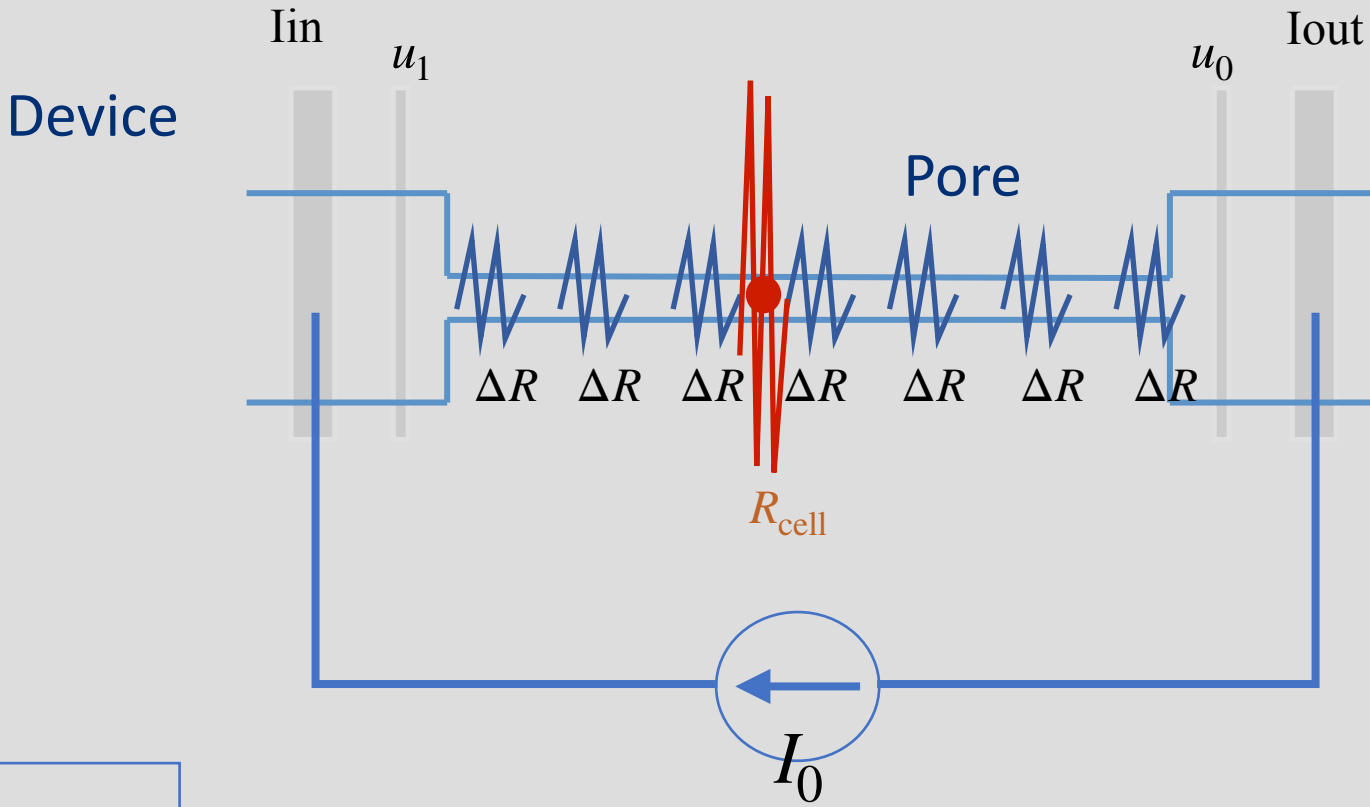

$$u_1 - u_0 = I_0(R + R_{\text{cell}})$$

Node-Pore Sensing

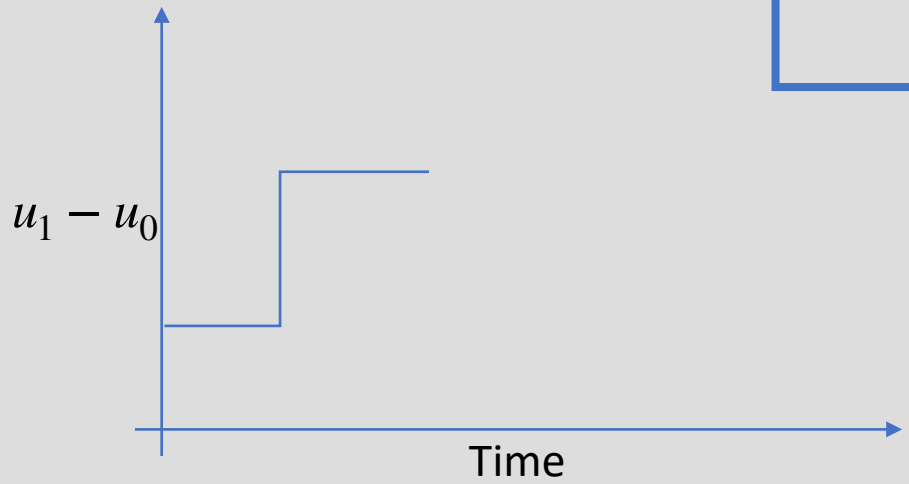
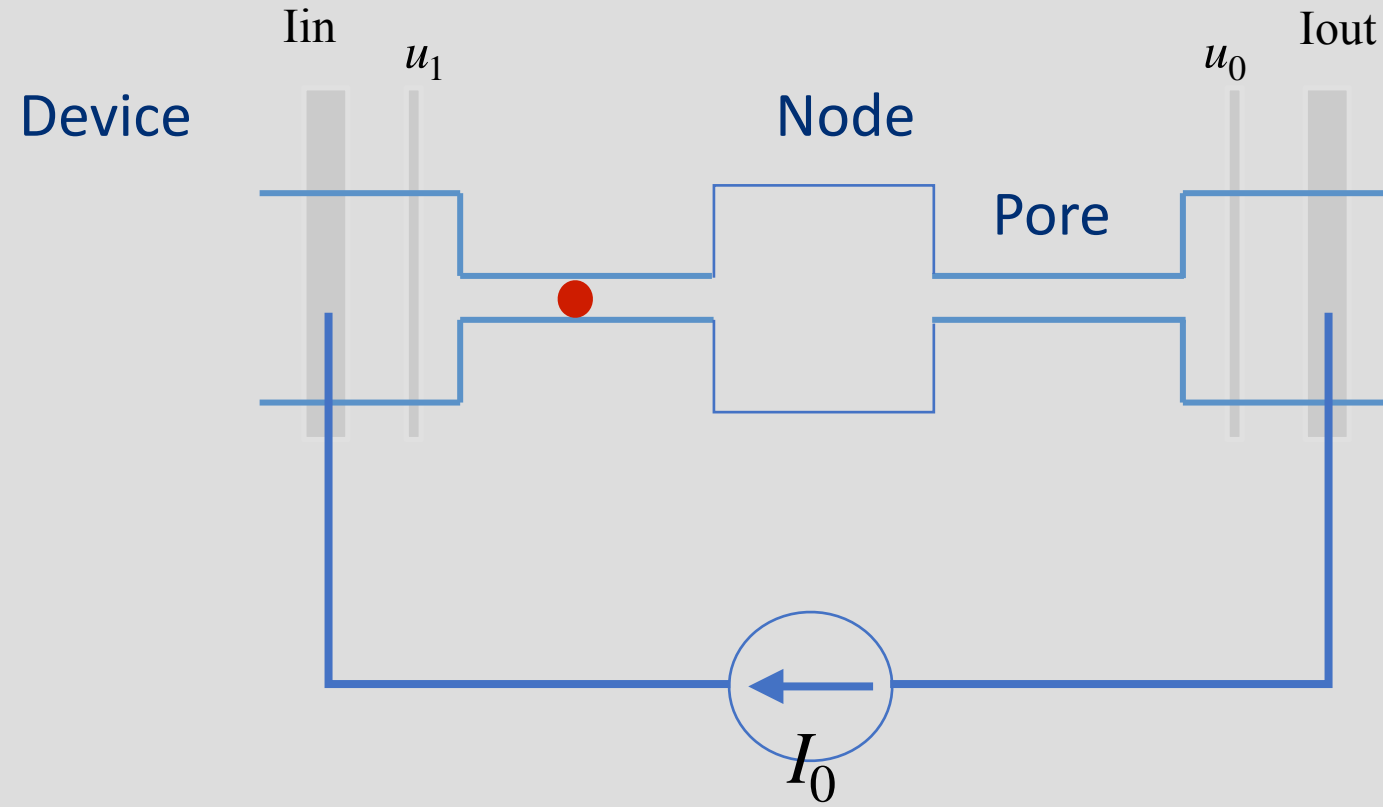

$$u_1 - u_0 = I_0(R + R_{cell} + R_{node})$$

Node-Pore Sensing

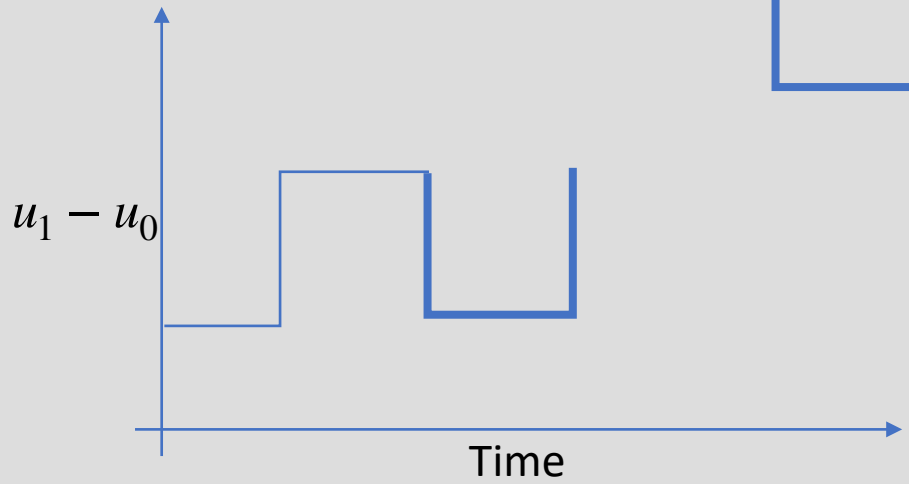
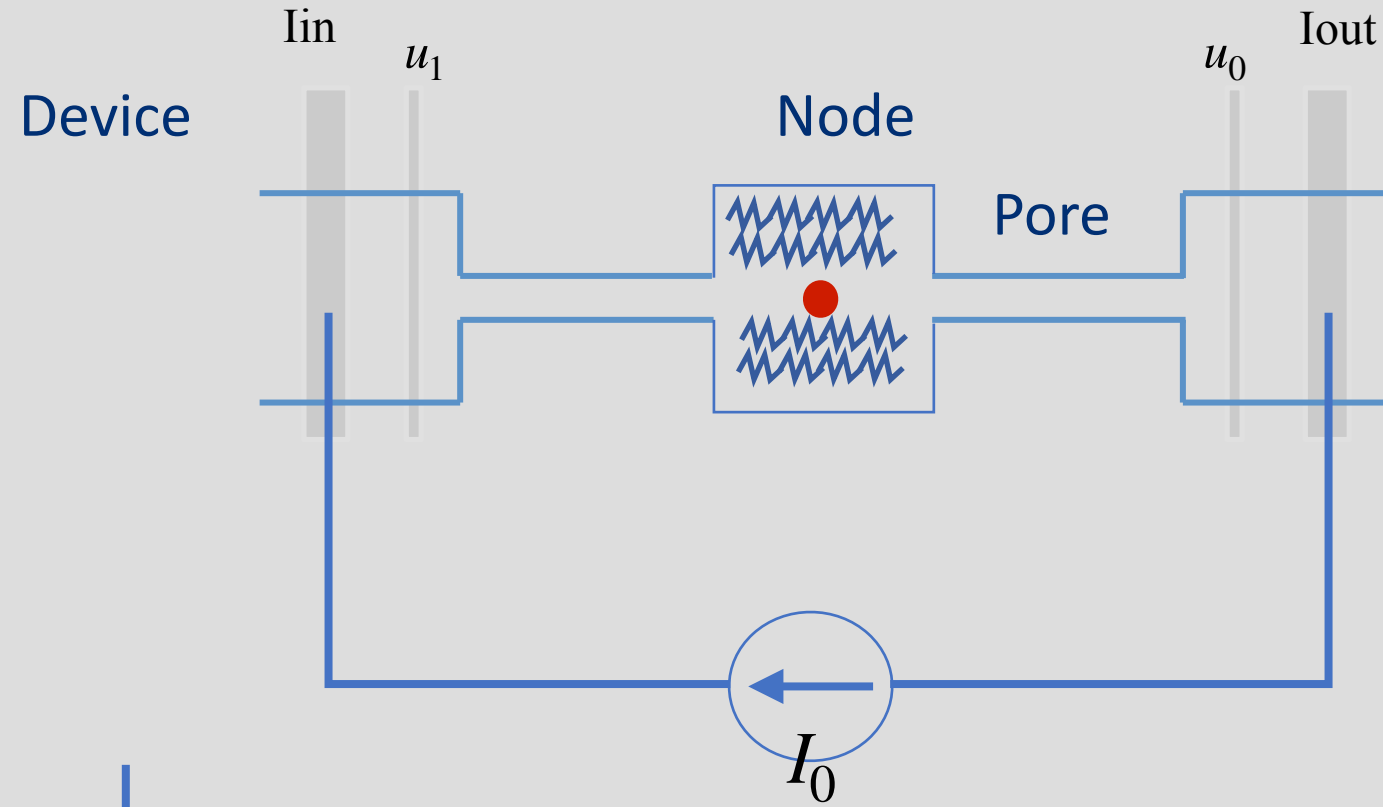

$$u_1 - u_0 = I_0(R + R_{cell} \parallel R_{node})$$

Node-Pore Sensing

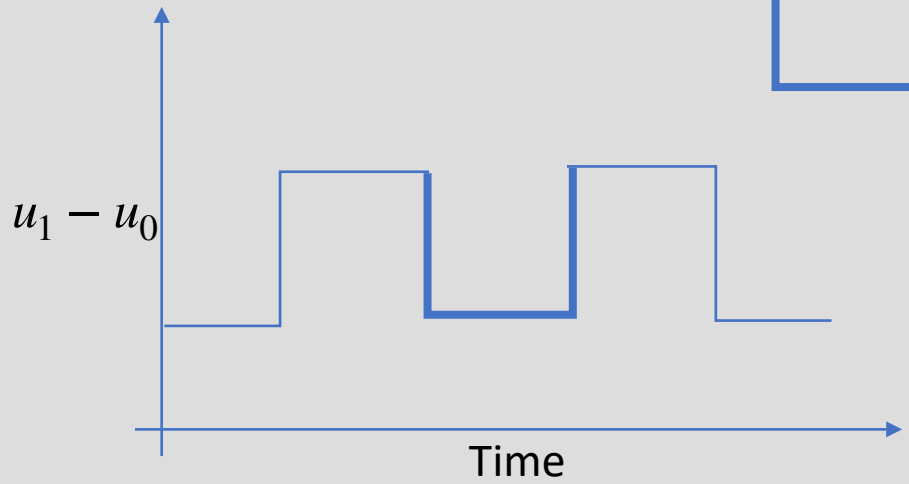
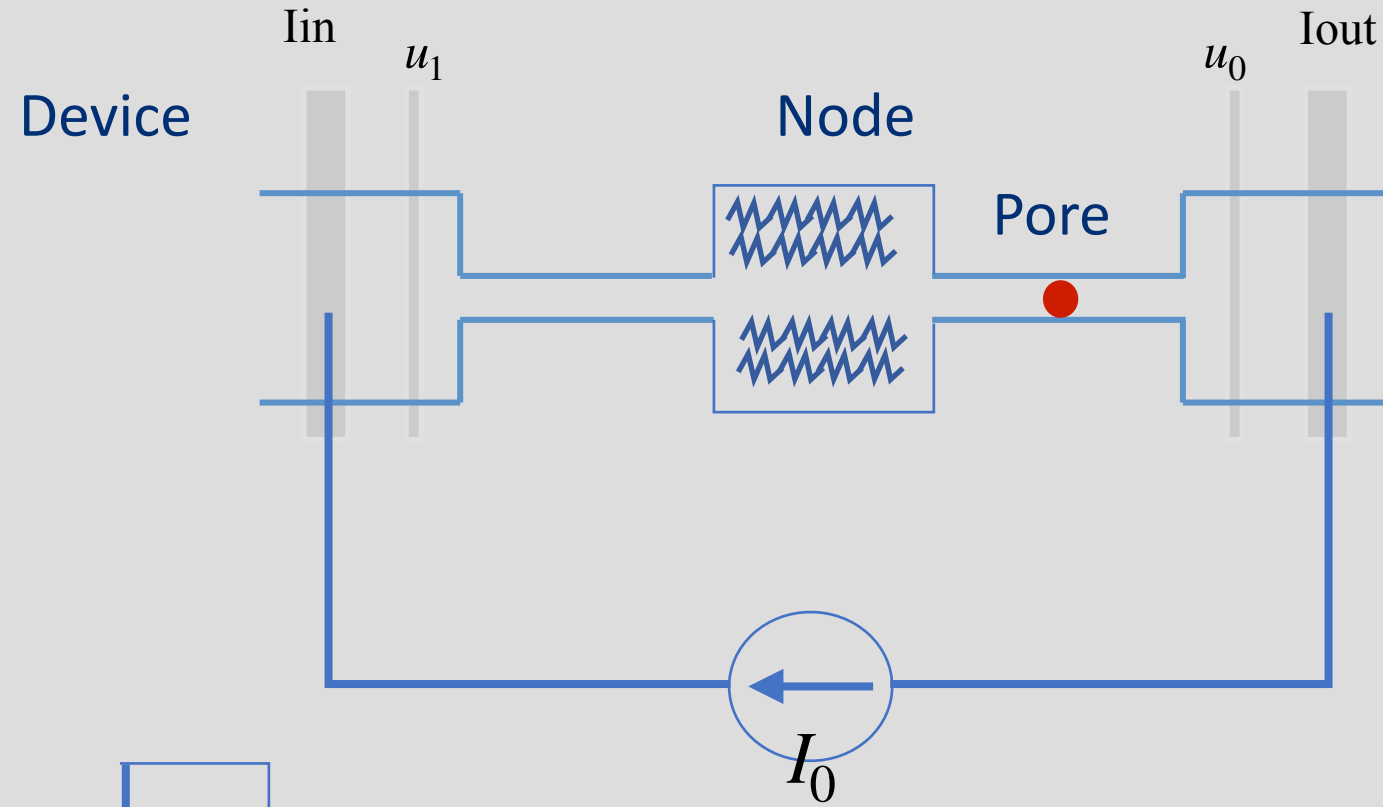

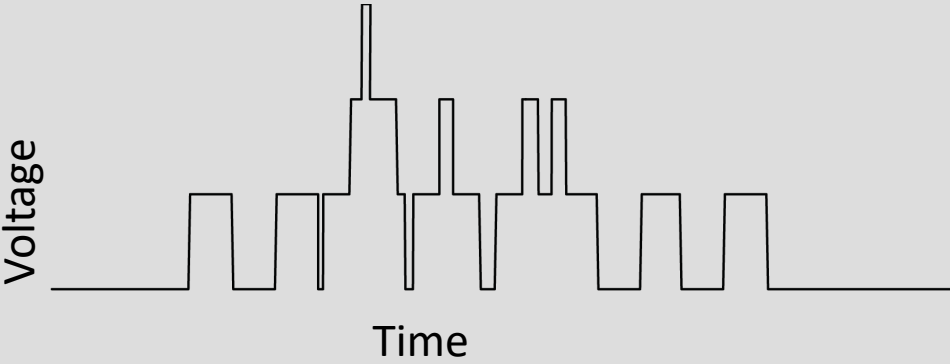
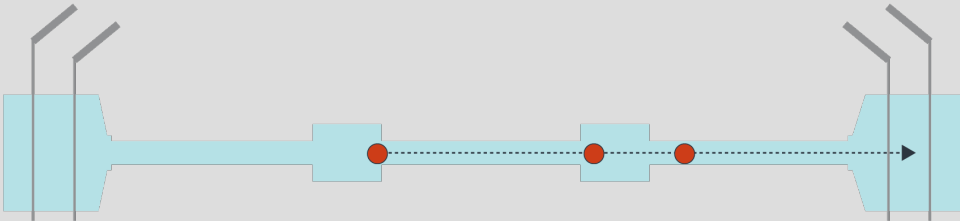
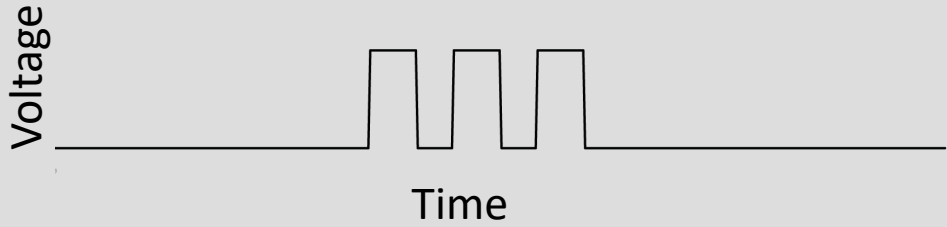
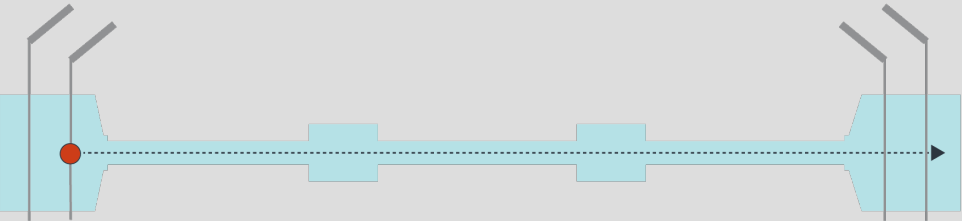

$$u_1 - u_0 = I_0(R + R_{cell} + R_{node})$$

Sensing Complexities

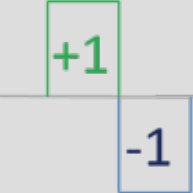

Barker Codes

- 9 unique sequences

Barker 2 : +1 -1 or +1 +1 ->  or 

Barker 3 : +1 +1 -1

Barker 4 : +1 +1 -1 +1 or +1 +1 +1 +1 -1

Barker 5 : +1 +1 +1 -1 +1

Barker 7 : +1 +1 +1 -1 -1 +1 -1

Barker 11 : +1 +1 +1 -1 -1 -1 +1 -1 -1 +1 -1

Barker 13 : +1 +1 +1 +1 +1 -1 -1 +1 +1 -1 +1 -1 +1



Auto-Correlation of Barker Codes

Barker 7

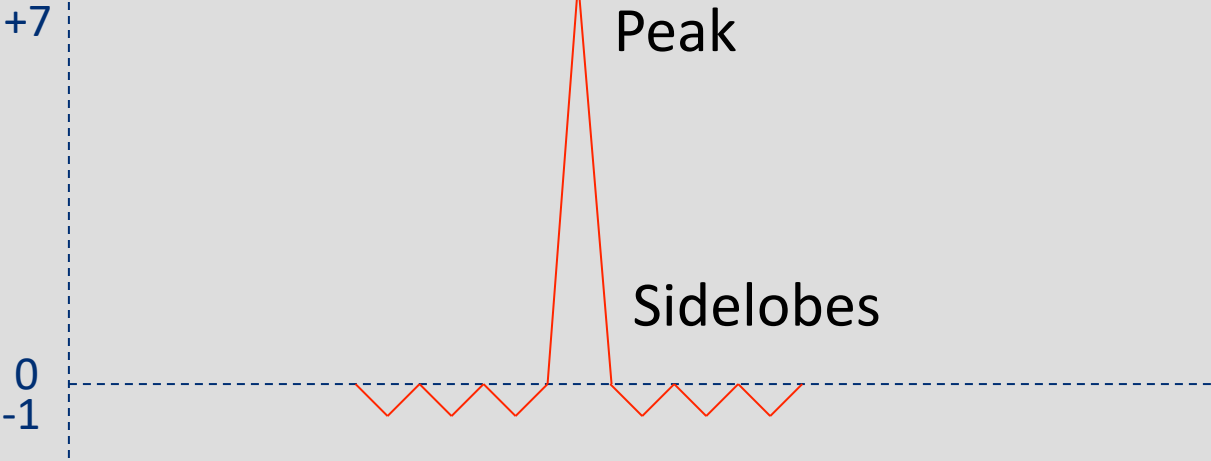
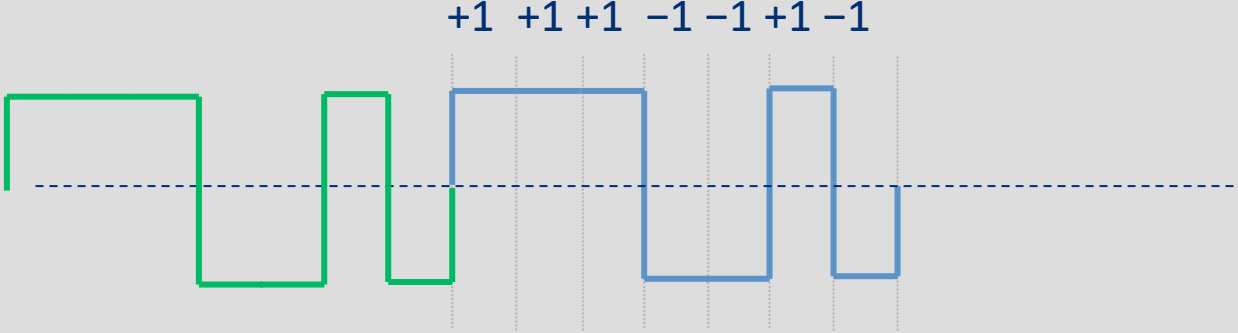

Cross Correlation with Barker Codes

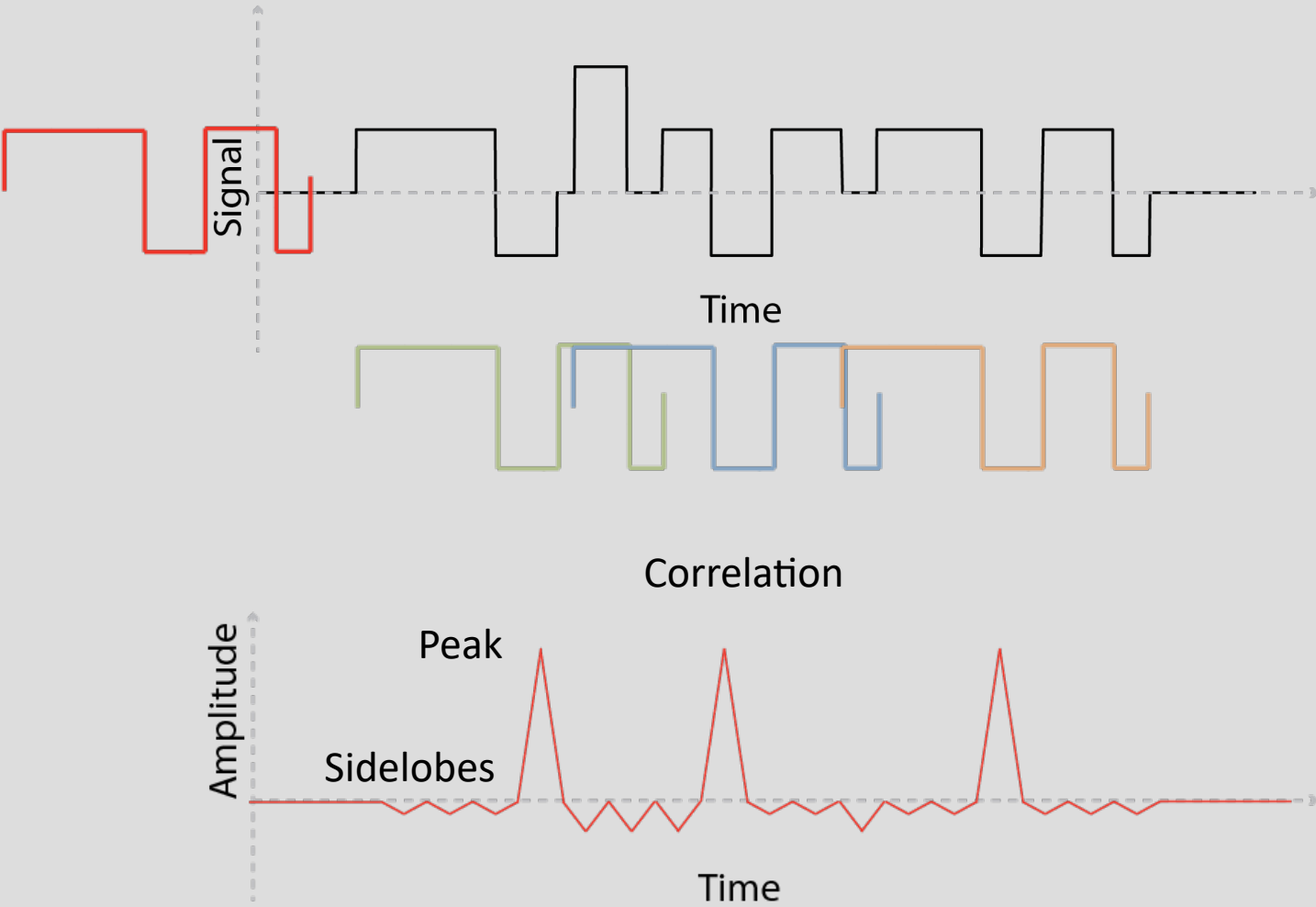

Implementing Barker Codes in NPS

Barker 5: +1,+1,+1,-1,+1

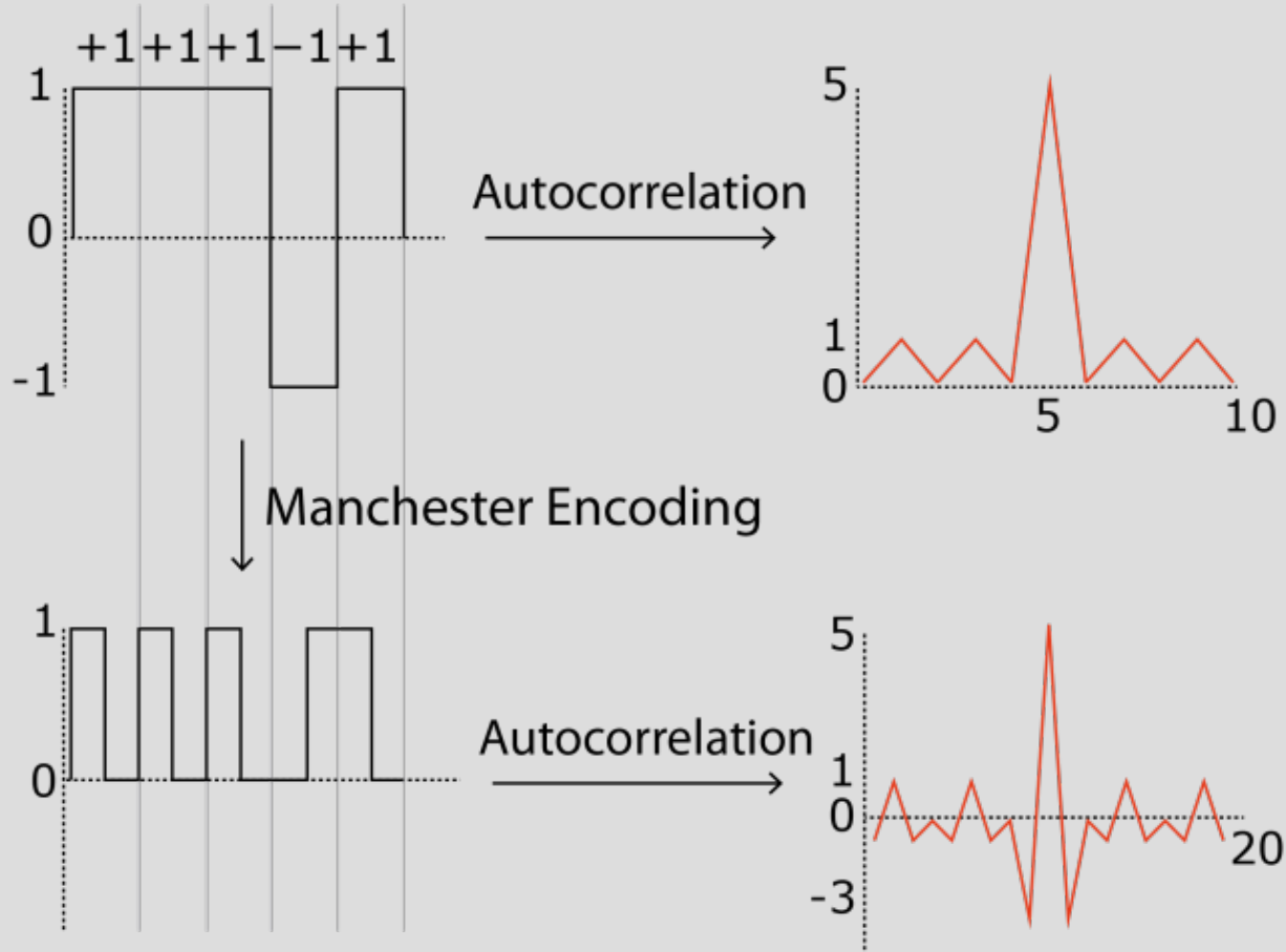

Encoding a Channel

Barker 5 : +1 +1 +1 -1 +1

Encoded Signal : 1 0 1 0 1 0 0 1 1 0

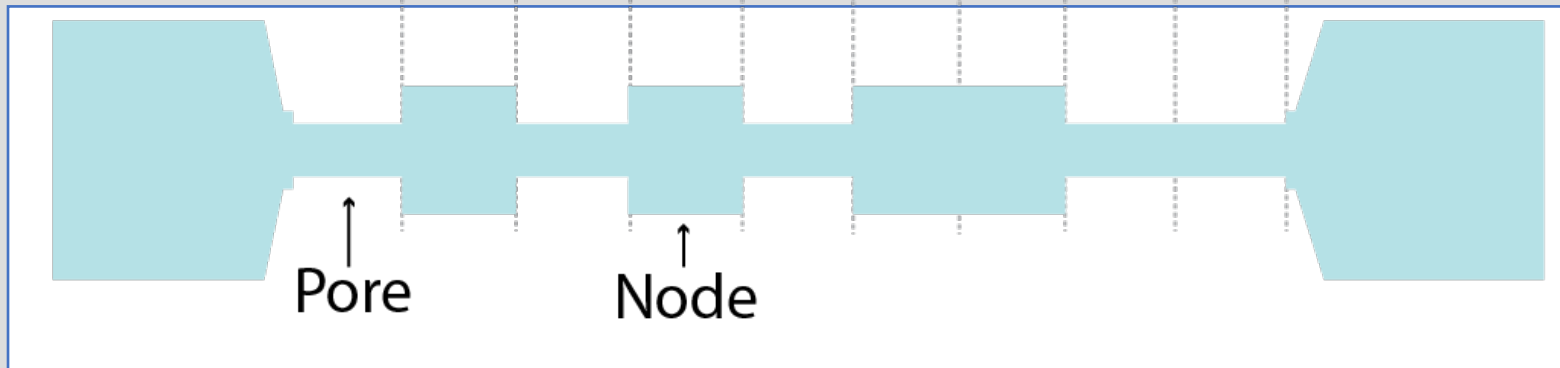
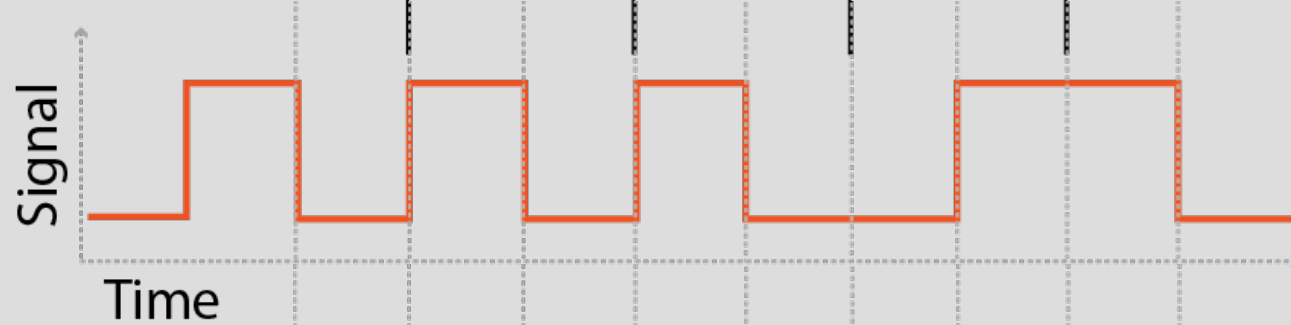

(Kellman et. al IEEE Sens. J 18(8):3068-79)

<https://www.ncbi.nlm.nih.gov/pmc/articles/PMC6034687/>

Real Data

 26 mm/s

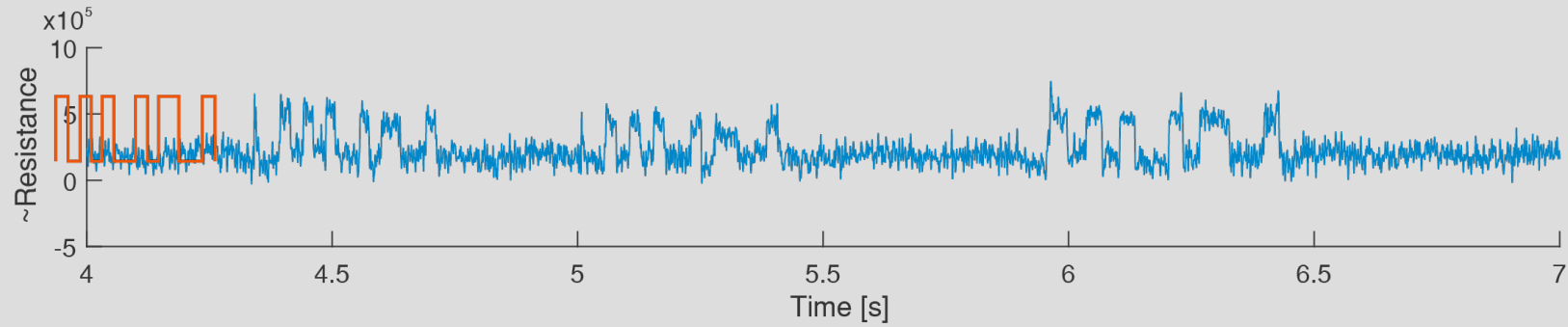

Correlation plot

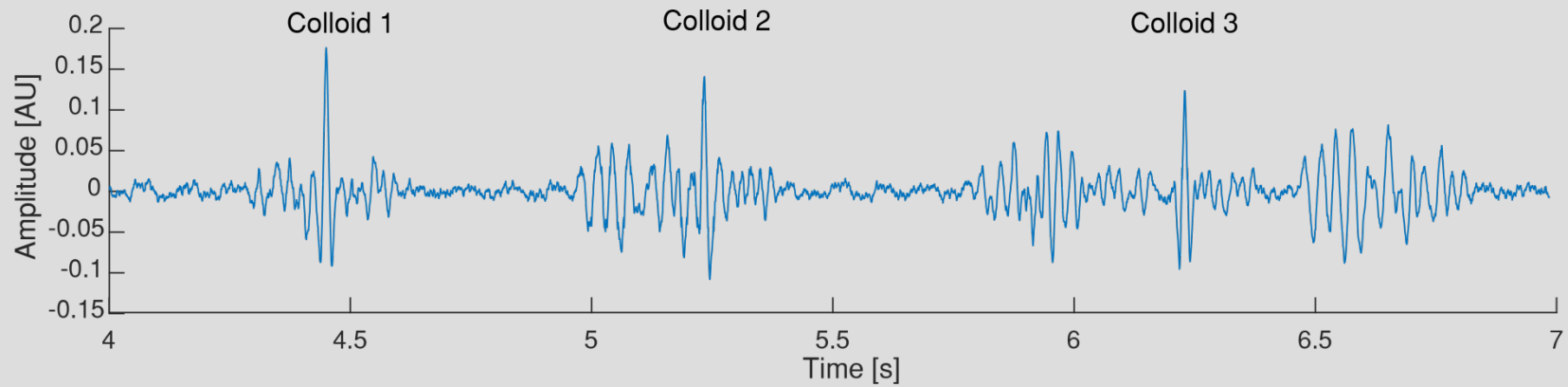

Speed and Time

